



CORNERSTONE
CORPORATION
Surgical Instruments Catalogue

Surgical Instruments Catalogue



P.O. Box # 1333, Nai Abadi Bhoth,
Sialkot 51310 - Pakistan.
Phone: +92-52-4271651
Fax: +92-52-4263208
Email: cstone@brain.net.pk
info@corner-stone.biz
Website: www.corner-stone.biz

About us

Reliable quality and fair prices that's what the CORNERSTONE production program stands for, and this principle is getting more and more important in an economically difficult environment.

We, CORNERSTONE are one of the leading manufacturers and worldwide exporters of Surgical Instruments, it's a family owned company in manufacturing business since many years.

We, at CORNERSTONE understand the importance of quality in the manufacturing process, that's why we maintain a total quality improvement process in manufacturing throughout our company.

All manufacturing process are continually reviewed by our top management not only to maximize productivity, but also to guarantee that products manufactured meet the highest quality standard and are fit for the intended purposes by all suitable means.

Our peoples are constantly thinking of new and better ways to meet customer requirements and entire satisfaction to have them peace of mind.

Our products and further information are available from our dealers worldwide, and under our website www.corner-stone.biz

We are always at your service.

Chief Executive

CORNERSTONE CORPORATION



Care and Handling of Instruments

Concerning your question on why staining, pitting or rusting can develop in stainless steel Instruments; there are some basic points for the care and handling of surgical instruments which will extend the life of the instrument, eliminate staining or corrosion and lower the cost in use. These are as follows: -

1. Instruments should be rinsed as soon as possible after use to remove blood, serum and saline. Do not use a sponge basin as any residue from normal saline solution can cause corrosion to develop over a period of time.
2. Instruments should be thoroughly dried after cleaning and before wrapping or storing, as moisture left in the box lock or serrations can cause rust or corrosion to develop.
3. Do not leave instruments in a cold sterilization soak solution for extended periods as these solutions tend to be corrosive, after cold sterilization, rinse the instruments in distilled or demineralized water and dry thoroughly).
4. If using cold sterilization technique, change the solution according to directions as prolonged use will cause the solution to become corrosive.
5. Do not use caustic cleaners or any other cleaner except those specified for cleaning surgical instruments.
6. Do not clean instruments with steel wool or scouring powder, or use PH detergents. If cleaning by hand, use a specific instrument cleaner or a natural detergent soap and a soft brush (rinse with demineralized or distilled water).
7. Check your autoclave. Iron, sodium, calcium, magnesium or copper in your water can cause spotting, staining or corrosion to occur. In hard water areas, clean the line deposits from your autoclave, install a steam filter if possible. It will remove most of dirt, rust and pipe scale.
8. Make sure your wraps are rinsed sufficiently (6 to 8 times) by the laundry to remove all chlorine bleach as any residue can cause staining or corrosion during autoclaving.

Care and Handling of Instruments

9. Do not leave instruments in the following solutions for extended periods as corrosion can result: -

- a) Aluminum, Barium, Calcium, Ferrous or stannous chloride solutions.
- b) Phenol, Lysol or Iodine.
- c) Dakin's Solution or Zephiran.
- d) Any acid, Mercury or potassium solution.

10. Do not sterilize stainless steel instruments with chrome plated instruments if possible, as any break in the surface of the chrome plate will allow an electrolytic action develop between the dissimilar metals, causing pitting and/or a rusty appearance to develop.

11. Preheat instruments in autoclave before allowing steam to enter, if possible, to prevent an excessive amount of condensation forming on the surface of the instruments.

12. Don't open the autoclave too quickly after the sterilization cycles as excessive condensation will develop on the surface of the instruments (crack the door to allow drying before opening fully).

If you follow the above rules and use instrument cleaners and lubricant milk, your instruments should remain rust, spot and stain free.

I hope this will answer any questions you might have on this topic.

10

Diagnostic Instruments

Page 01 to 05



11

Puncture Instruments

Page 06 to 08



12

Anaesthesia Instruments

Page 09 to 19



13

General Instruments

Scalpels

Page 20 to 33



14

General Instruments

Scissors

Page 34 to 94



15

General Instruments

Forceps

Page 95 to 115



16

General Instruments

Hemostatic/Cotton Swab Forceps

Page 116 to 149



17

General Instruments

Retractors

Page 150 to 209



18

General Instruments

Probes, Applicators & Spatulas

Page 210 to 215

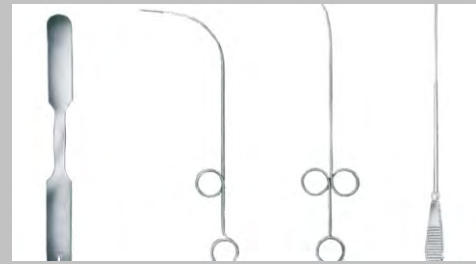

19

Suture Instruments

Page 216 to 255



20

Plaster Instruments

Page 256 to 257



21

Bone Instruments

Page 258 to 324



22

Tracheotomy Instruments

Page 325 to 326



23

Goitre Instruments

Page 327

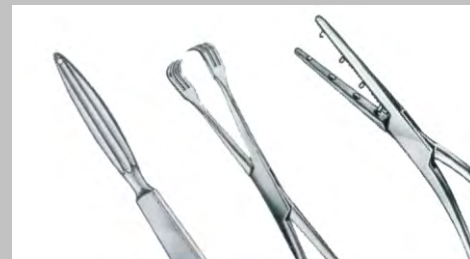

24

Dermatology Instruments

Page 328 to 329

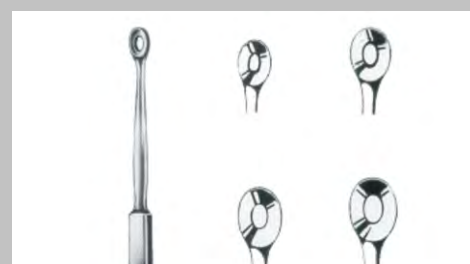

25

Stomach, Intestine & Rectum Instruments

Page 330 to 351



26

Kidney, Liver and Gall Stone, Urology Instruments

Page 352 to 365



27

Gynecology Instruments

Page 366 to 404



28

Obstetrics Instruments

Page 405 to 411



29

Cardiovascular Instruments

Page 412 to 458



30

Ophthalmology Instruments

Page 459 to 505



31

Neuro & Laminectomy Instruments

Page 506 to 537

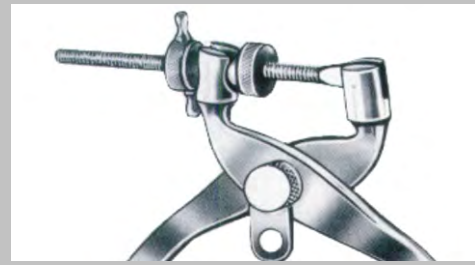

32

Micro Instruments

Page 538 to 563

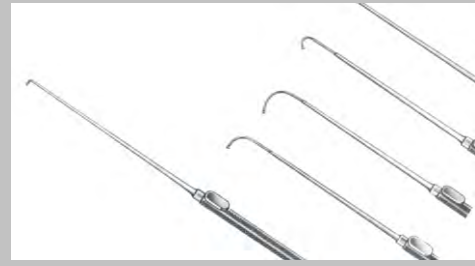

33

Otology Instruments

Page 564 to 588



CONTENTS

34

Rhinology Instruments

Page 589 to 614



35

Oral Instruments

Page 615 to 619

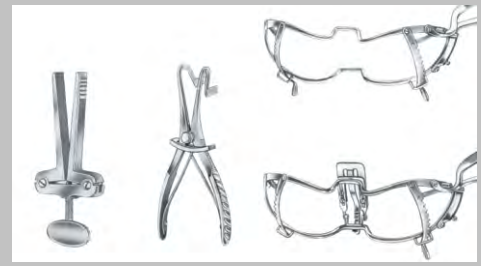

36

Tonsil Instruments

Page 620 to 625

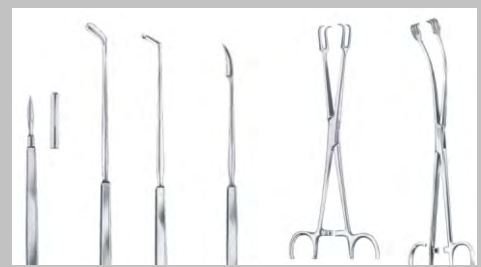

37

Broncho-Esophagoscopy Instruments

Page 626 to 631



38

Sterilizing Instruments

Page 632



39

Asepsis

Page 633 to 634

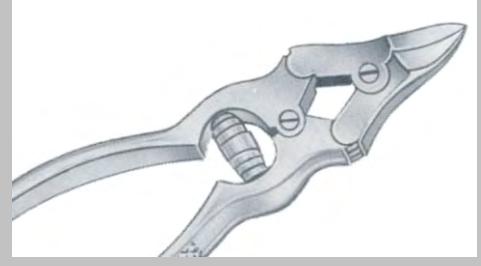

40

Holloware

Page 635 to 640



CONTENTS



Aly
10-01000-17
17cm/6¾"



Wartenberg
10-01004-19
19cm/7½"



Weber
10-01008-09
9cm/3½"



wood

Pinard
10-01012-18
18cm/7"



aluminium

Pinard
10-01016-15
15cm/6"



Chest piece only
10-01020-01

Ford
10-01020-00



Chest piece only
10-01024-01

Dual
10-01024-00



Buck
10-01028-18
18cm/7"



Buck
10-01032-18
18cm/7"



Troemner
10-01036-24
24cm/9½"



Taylor
10-01040-16 16cm/6½"
10-01040-18 18cm/7"
10-01040-20 20cm/8"



with pin
10-01044-20
20cm/8"

without pin
10-01046-20
20cm/8"

Dejerine
20cm/8"

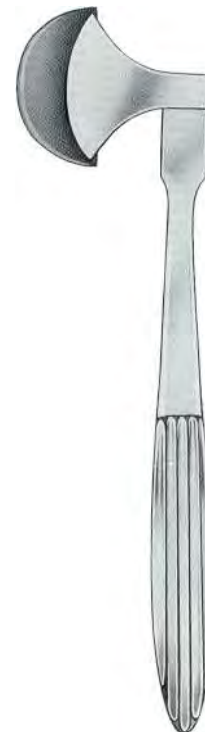

Berliner
10-01050-20
20cm/8"



Traube
10-01054-16
16 cm/6¼"



Troemner
10-01058-21
21cm/8¼"



Divers-Duoflex
10-01062-22
22 cm/8¾"



Babinsky
10-01066-22 22 cm/8¾"
10-01066-25 25 cm/10"



Rabiner
10-01068-23
23 cm/9¼"



National Hospital
10-01070-33
33 cm/13"



Queen Square
10-01074-26
26 cm/10¼"



10-01078-00



10-01082-00



10-01086-00



Jansen
10-01092-00



Collin
for children 10-01096-01 for adults 10-01096-02

Goniometer



Moltgen
10-01100-00



Caroll
10-01104-14
14cm/5½"



Townley
10-01108-10
10cm/4"



Standard (Nelson)
 \varnothing mm 11cm/4½"

3.0	11-01112-30
3.5	11-01112-35
4.0	11-01112-40
4.5	11-01112-45
5.0	11-01112-50
5.5	11-01112-55
6.0	11-01112-60



Standard (Nelson)
 \varnothing mm 12cm/4¾"

3.0	11-01116-30
3.5	11-01116-35
4.0	11-01116-40
4.5	11-01116-45
5.0	11-01116-50
5.5	11-01116-55
6.0	11-01116-60



Standard (Nelson)
 \varnothing mm 12cm/4¾"

3.0	11-01120-30
3.5	11-01120-35
4.0	11-01120-40
4.5	11-01120-45
5.0	11-01120-50
5.5	11-01120-55
6.0	11-01120-60



Universal

11-01124-03 =3 Set of 3
 11-01124-04 =4 Set of 4



Ø6



4 ½



3



1¾ mm



Universal

11-01128-03 =3 Set of 3
 11-01128-04 =4 Set of 4

Ø 2 mm



Landau
11-01132-16
16cm/6¼"

Ø 2 mm



Landau
11-01136-19
19cm/7½"

Ø 13.5mm



Peau
11-01140-16
16cm/6¼"

Ø 8 mm



Buelau
11-01144-24
24cm/9½"



Nelson

Ø mm	21cm/8¼"
7.5	11-01148-07
9.0	11-01148-09
10.5	11-01148-10
12.0	11-01148-12



Ochsner

Ø mm	14.5cm/5½"
4.0	11-01152-40
4.6	11-01152-46
5.5	11-01152-55
6.5	11-01152-65

Ø5.5 mm



Krause
 11-01156-15
 15cm/6"

Ø2.25 mm



Coakley
 11-01160-16
 16cm/6¼"

Ø1.8 mm



Lichtwitz
 11-01164-19
 19cm/7½"

Ø3 mm



Douglas
 11-01168-11
 11.5 cm/4½"



11-01172-11
 11.5 cm/4½"



Pierce

Ø mm	
3.0	11-01176-03
4.0	11-01176-04
5.0	11-01176-05



Ømm	Frazier Charr./Fr.
2	6 12-01180-06
2 1/3	7 12-01180-07
2 2/3	8 12-01180-08
3	9 12-01180-09
3 1/3	10 12-01180-10
3 2/3	11 12-01180-11
4	12 12-01180-12
5	15 12-01180-15



Ømm	Ferguson Charr./Fr.
2	6 12-01184-06
2 1/3	7 12-01184-07
2 2/3	8 12-01184-08
3	9 12-01184-09
3 1/3	10 12-01184-10
3 2/3	11 12-01184-11
4	12 12-01184-12

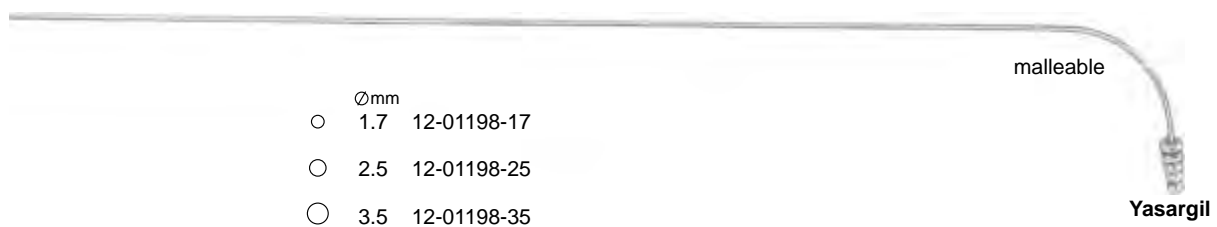
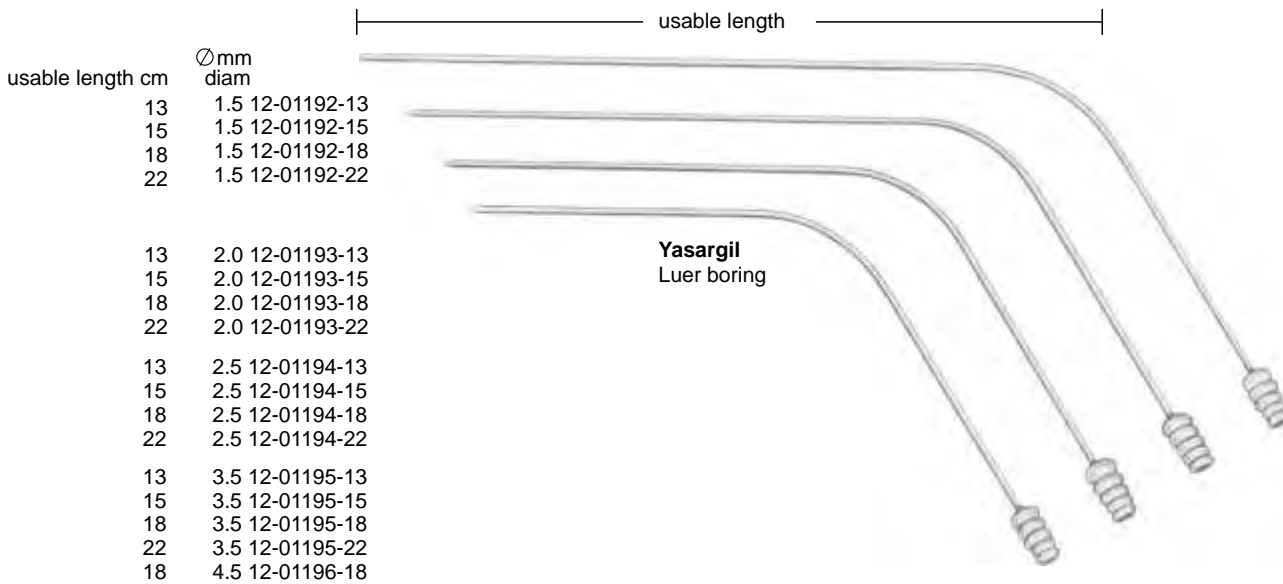

Brain Suction Tubes



- ∅ **Frazier**
 2.0 mm 12-01202-20
 2.5 mm 12-01202-25
 3.0 mm 12-01202-30
 13cm/5"



- ∅ **Plester**
 1.5 mm 12-01206-15
 2.0 mm 12-01206-20
 2.5 mm 12-01206-25
 3.0 mm 12-01206-30
 19.5cm/7¾"



- Adson**
 12-01210-02
 21cm/8¼"
 ∅4 mm

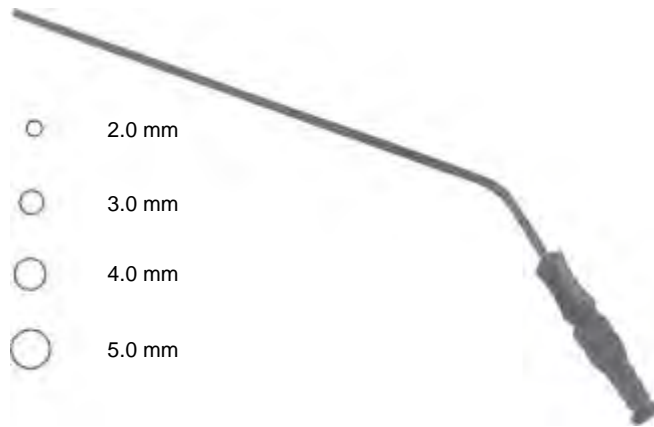

- ∅ malleable, black
 2 mm 12-01214-02
 3 mm 12-01214-03
 4 mm 12-01214-04
 5 mm 12-01214-05
 19.5cm/7¾"



Yankauer
12-01218-27
27cm/10½"



Yankauer
12-01219-27
27cm/10½"



Yankauer
12-01220-01



Fig. 0
12-01220-10



Fig. 1
12-01220-11



Fig. 2
12-01220-12



Fig. 3
12-01220-13

12-01220-50 SET

∅ 6 mm
round



Nuboer
12-01224-01
21cm/8¼"

6 mm
ovale



Nuboer
12-01224-02
21cm/8¼"

∅ 6 mm



Andrew-Pynchon
12-01228-23
23 cm/9"



Finsterer
12-01232-30
30cm/12"

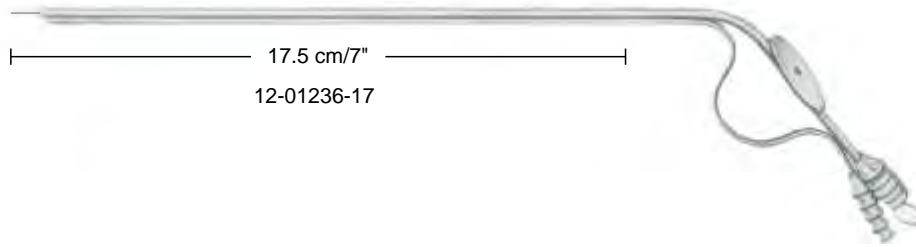

17.5 cm/7"
12-01236-17

Ø 6 mm



Baby-Poole
12-01240-20
20cm/8"

Ø10 mm



Poole
12-01240-22
22cm/8¾"

Ø 8 mm



Poole
12-01244-22
22cm/8¾"



Yankauer
12-01248-34
34.5cm/13¼"

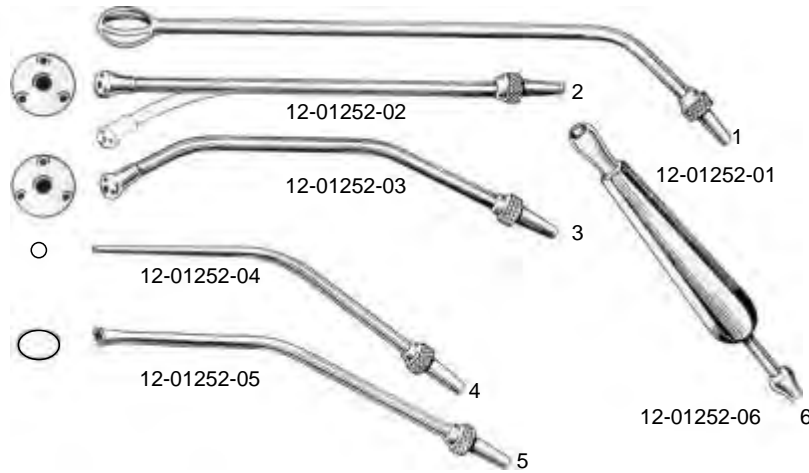

Yankauer universal
Complete Set
12-01252-60



Magill
12-01256-01=20cm/8"
12-01256-02=20cm/8"
12-01256-03=20cm/8"



Millin
12-01262-30
30cm/12"



Simpson-Smith
12-01266-00



Schimmelbusch
12-01272-01 Child
12-01272-02 Adult



Magill
12-01280-15 15 cm/6" Infant
12-01280-20 20 cm/8" Child
12-01280-25 25 cm/10" Adult



Yankauer
12-01276-01 Child
12-01276-02 Adult



Connel
12-01284-01 Child
12-01284-02 Adult



12-01288-01



Lumbard-Mayo
12-01288-02



12-01288-03



Magill
Connection Set
12-01292-00



Magill (Nasal)

	mm dia
12-01292-01	5.5
12-01292-02	6.5
12-01292-03	7.5
12-01292-04	8.0
12-01292-05	8.5
12-01292-06	9.5
12-01292-07	10.0
12-01292-08	10.5



Magill (Aural)

	mm dia
12-01296-01	5.5
12-01296-02	6.5
12-01296-03	7.5
12-01296-04	8.0
12-01296-05	8.5
12-01296-06	9.5
12-01296-07	10.0
12-01296-08	10.5



Cobb
12-01300-01 Small
12-01300-02 Medium
12-01300-03 Large



Ayre
12-01304-01 Small
12-01304-02 Medium
12-01304-03 Large



Hamilton Bailey
12-01308-01 Infant
12-01308-02 Child
12-01308-03 Adult



Mitchell
12-01312-18
12-01312-20
38 mm



McIntosh
12-01316-30
12-01316-40

12-01316-30
Laryngoscope Set
Consisting of:
12-01332-00 Battery Handle (without batteries)
12-01316-11 McIntosh blade, Fig 1
12-01316-12 ditto, Fig 2
12-01316-13 ditto, Fig 3



12-01316-10



12-01316-11

12-01316-40
Laryngoscope Set
Consisting of:
12-01332-00 Battery Handle (without batteries)
12-01316-11 McIntosh blade, Fig 1
12-01316-12 McIntosh blade, Fig 2
12-01316-13 McIntosh blade, Fig 3
12-01316-14 McIntosh blade, Fig 4



12-01316-12



12-01316-13



12-01316-14

McIntosh Laryngoscope Blades
12-01316-10 Fig 0, Working length 55mm, baby's
12-01316-11 Fig 1, Working length 75mm, children's
12-01316-12 Fig 2, Working length 90mm, adolescent's
12-01316-13 Fig 3, Working length 110mm, women's
12-01316-14 Fig 4, Working length 135mm, men's



12-01320-30
Laryngoscope Set
Consisting of:
12-01332-00 Battery Handle (without batteries)
12-01320-12 Guedel-Negus Blade, Fig 2
12-01320-13 ditto, Fig 3
12-01320-14 ditto, Fig 4

Guedel-Negus
12-01320-30
12-01320-40

12-01320-40
Laryngoscope Set
Consisting of:
12-01332-00 Battery Handle (without batteries)
12-01320-11 Guedel-Negus Blade, Fig 1
12-01320-12 Guedel-Negus Blade, Fig 2
12-01320-13 Guedel-Negus Blade, Fig 3
12-01320-14 Guedel-Negus Blade, Fig 4



12-01320-11



12-01320-12



12-01320-13



12-01320-14

Guedel Laryngoscope Blades
12-01320-11 Fig 1, working length 70mm, children's
12-01320-12 Fig 2, working length 90mm, adolescent's
12-01320-13 Fig 3, working length 110mm, women's
12-01320-14 Fig 4, working length 135mm, men's



Foregger
12-01324-30
12-01324-40

12-01324-30
Laryngoscope Set
Consisting of:
12-01332-00 Battery Handle (without batteries)
12-01324-12 Foregger Blade, Fig 2
12-01324-13 ditto, Fig 3
12-01324-14 ditto, Fig 4

12-01324-40
Laryngoscope Set
Consisting of:
12-01324-00 Battery Handle (Without batteries)
12-01324-11 Foregger Blade, Fig 1
12-01324-12 Foregger Blade, Fig 2
12-01324-13 Foregger Blade, Fig 3
12-01324-14 Foregger Blade, Fig 4

12-01324-11



12-01324-12



12-01324-13



12-01324-14



Foregger Laryngoscope Blade,
12-01324-11 Fig 1, working length 70mm, children's
12-01324-12 Fig 2, working length 90mm, adolescent's
12-01324-13 Fig 3, working length 110mm, women's
12-01324-14 Fig 4, working length 135mm, men's



Working length 55 mm
12-01328-10

Working length 80 mm
12-01328-11

12-01328-20
Laryngoscope Set, Baby and Infant,
consisting of :
12-01332-00 Battery Handle (without battery)
12-01328-10 Miller-baby blade, Fig 0
working length 55 mm
12-01328-11 ditto, Fig 1 working length 80 mm

Miller-Baby
12-01328-20



32 mm dia
12-01332-00



28 mm dia
12-01336-00



18 mm dia
12-01340-00



Negus
18 mm dia
12-01344-00



No. 3

13-01348-03



No. 3

13-01352-03



No. 4

13-01356-04



No. 4

13-01360-04

double handle
number 3 + number 4



No. 7

13-01364-07



No. 7k

13-01368-17



No. 8

13-01372-08



No.9

13-01376-09



13-01380-34

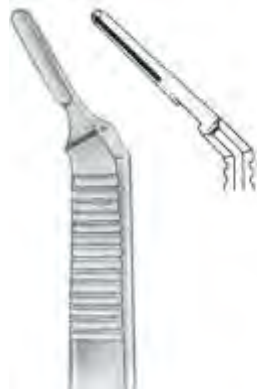

3L
13-01384-13



4L
13-01388-14



No. 3L
13-01392-03



No. 4L
13-01396-04



No. 5
13-01400-05
15cm/6"



No. 5A
13-01404-15
15cm/6"



13-1408-01
21cm/8¼"



13-01408-03



17cm/6¾"



Fig. 1

13-01412-01



Fig. 2

13-01412-02



Fig. 3

13-01412-03



Fig. 4

13-01412-04



Fig. 5

13-01412-05



Fig. 6

13-01412-06



Fig. 7

13-01412-07



Fig. 8

13-01412-08



Fig. 9

13-01412-09



Fig. 10

13-01412-10



Fig. 1
13-01416-01



Fig. 2
13-01416-02



Fig. 3
13-01416-03



Fig. 4
13-01416-04



Fig. 5
13-01416-05



Fig. 6
13-01416-06



Fig. 7
13-01416-07



Fig. 8
13-01416-08



Fig. 9
13-01416-09



17cm/6¾"



Fig. 10
13-01416-10



Fig. 11
13-01416-11



Fig. 12
13-01416-12



Fig. 13
13-01416-13



Fig. 14
13-01416-14



Fig. 15
13-01416-15



Fig. 16
13-01416-16



Fig. 18
13-01416-18



Fig. 27
13-01416-27



Fig. 38
13-01416-38



Fig. 40
13-01416-40



Fig. 46
13-01416-46



Fig. 61
13-01416-61



Fig. 63
13-01416-63



Dieffenbach
17cm/6³/₄"



Fig. 1
13-01420-01



Fig. 2
13-01420-02



Fig. 3
13-01420-03



Fig. 4
13-01420-04



Fig. 5
13-01420-05



Fig. 6
13-01420-06



Fig. 7
13-01420-07



Fig. 8
13-01420-08



Fig. 9
13-01420-09



Fig. 15
13-01420-15



Fig. 16
13-01420-16



◀ Fig. 1

Bergmann
13-01424-01
14.5cm/5¾"



Fig. 2
13-01424-02



Fig. 3
13-01424-03



Fig. 4
13-01424-04



Dieffenbach
13cm/5¼"



Fig. 1
13-01428-01



Fig. 2
13-01428-02



Fig. 3
13-01428-03



Fig. 4
13-01428-04



Fig. 5
13-01428-05



Fig. 6
13-01428-06



Fig. 7
13-01428-07



Fig. 8
13-01428-08



Fig. 9
13-01428-09



Fig. 10
13-01428-10



Fig. 11
13-01428-11



Fig. 12
13-01428-12



Simon
20cm/8"



Fig. 1
13-01432-01



Fig. 2
13-01432-02



Fig. 3
13-01432-03



Fig. 4
13-01432-04



Ulrich
22.5 cm/9"



Fig. 1
13-01436-01



Fig. 2
13-01436-02



Fig. 3
13-01436-03



Simon
23.5 cm/9 1/4 "



Fig. 1
13-01440-01



Fig. 2
13-01440-02



Fig. 3
13-01440-03



Fig. 4
13-01440-04



13-01444-01
7.5 cm/3"



13-01444-02
8 cm/3 1/4"



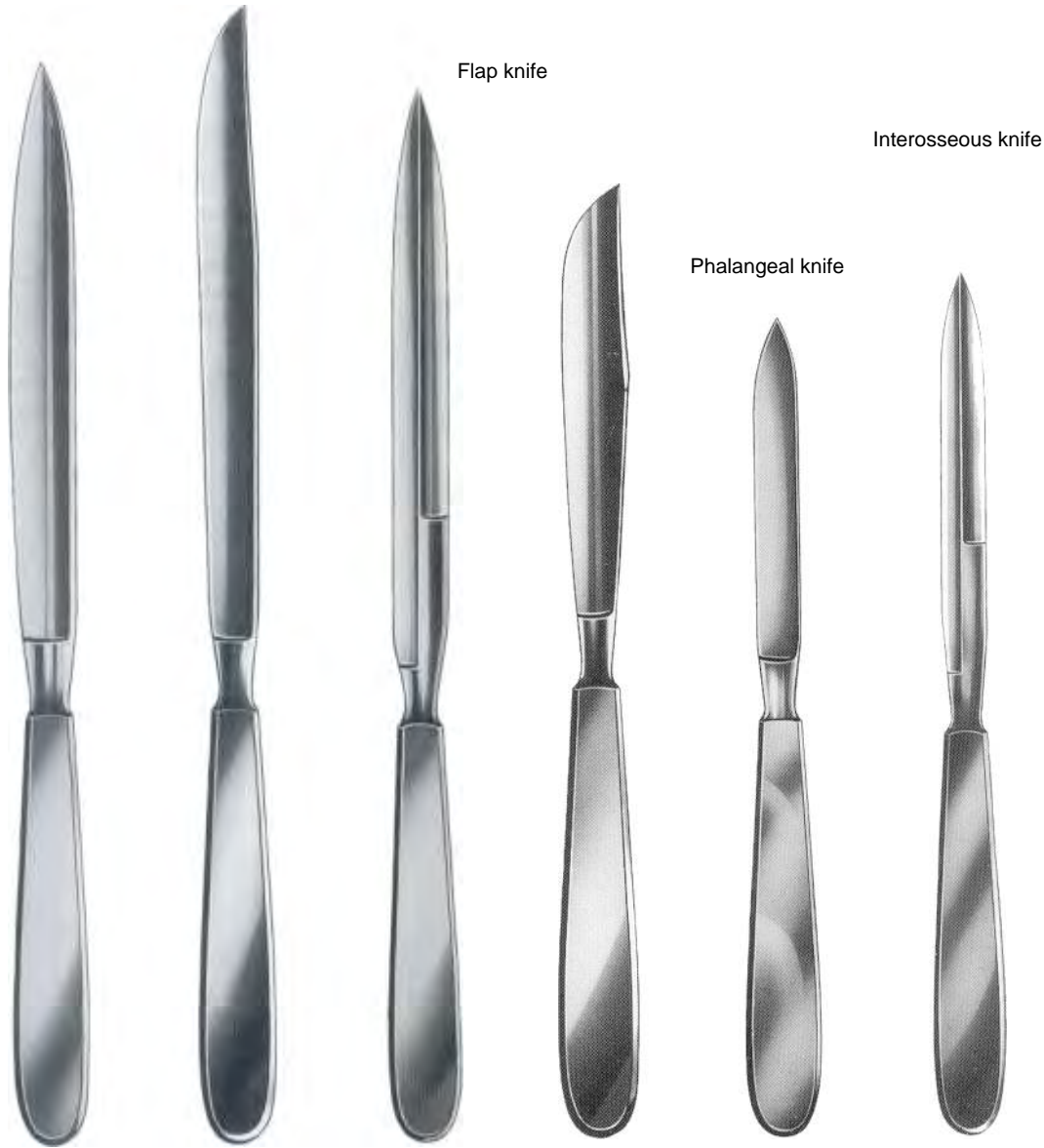

Length of blades		Liston	Catlin	Langenbeck	Phalangeal knife	Interosseous knife
cm	in					
9.5	3 ¾					13-01464-09
11.0	4 ½					13-01468-11
12.0	4 ¾			13-01460-12		
13.0	5	13-01448-13				
15.0	6					
16.0	6 ¼	13-01448-16		13-01456-16		
17.0	6 ¾		13-01452-17			
19.0	7 ½	13-01448-19		13-01456-19		
20.0	8		13-01452-20			
22.0	8 ¾	13-01448-22		13-01456-22		

General Instruments

Resection, Brains, Post Mortem and Autopsy Knives



Langenbeck
13-01472-01
18 cm/7"

Virchow

Length of blades

8.5 cm/3½"		13-01488-08
11.0 cm/4½"	13-01480-11	13-01484-11
14.0 cm/5½"	13-01480-14	
16.0 cm/6¼"	13-01476-16	
17.0 cm/6¾"	13-01480-17	
20.0 cm/8"	13-01476-20	
24.0 cm/9½"	13-01476-24	

Autopsy knives
Length of blades
19.5cm/7 3/4"

Length of blades
9.5cm/3 3/4"

Cartilage knives

Wooden handle

Metal handle

Virchow
13-01492-09

13-01496-19

13-01500-01

13-01504-01



Troutman-Chris
13-01508-09
9cm/3 1/2"



Troutman-Chris
13-01509-09
9cm/3 1/2"



13-01512-11
11cm/4 1/2"



Castroviejo
13-01516-13
13cm/5 1/4"



13-01520-18
18cm/7"



Skull Breaker

13-01524-14
14 cm/5½"



Rachiotome

13-01528-22
22 cm/8¾"



Osteotome

13-01532-13
13 cm/5"



Brunetti
13-01536-28
Brunetti
13-01537-28
28.5 cm/11¼"

Muscle hooks



13-01540-06
6.5 cm/2½"



13-01544-07
7 cm/2¾"

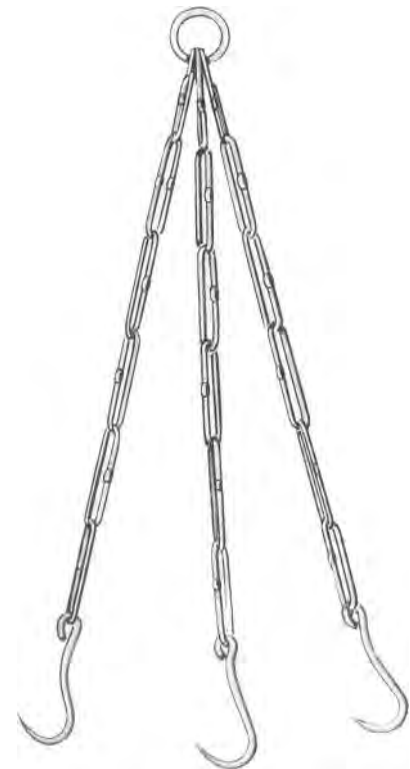

13-01548-01

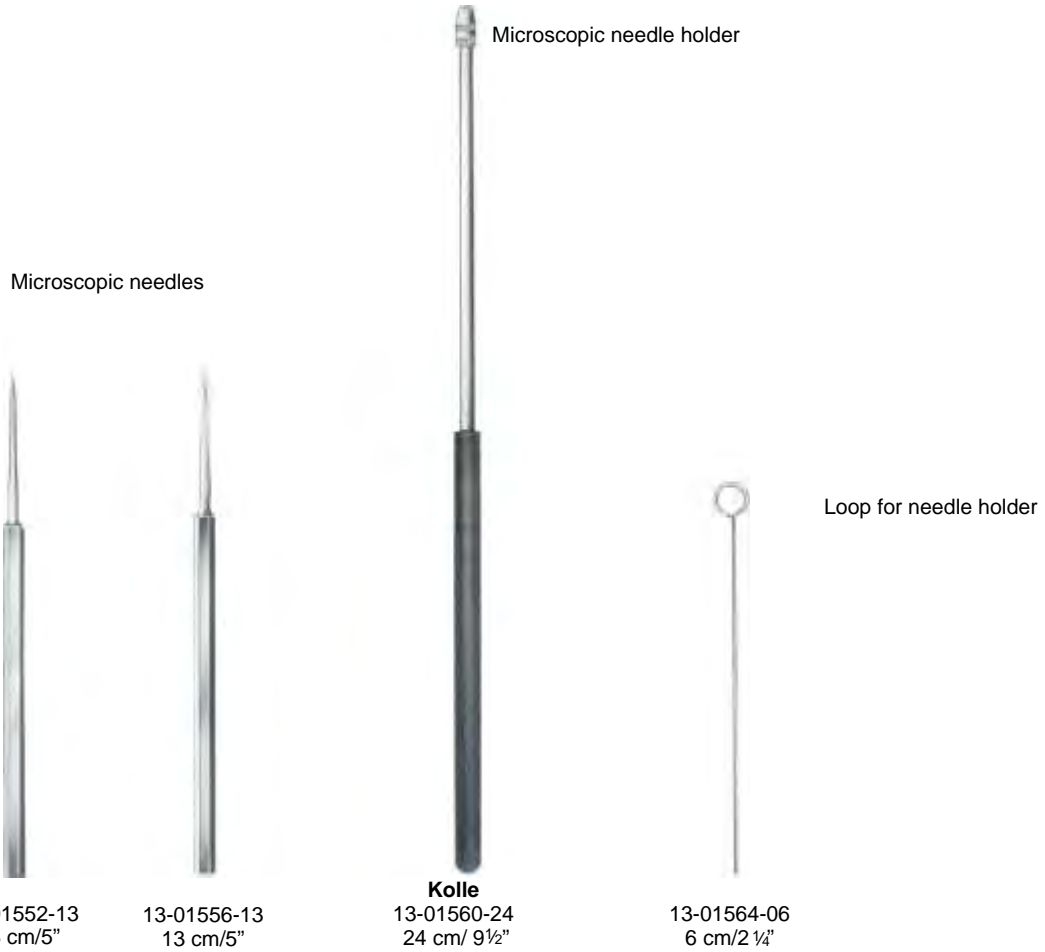

Post mortem needles





13-01572-00



13-01576-00

General Instruments
Supercut Scissors



Saw edge



Operating Scissor

Straight	Curved
14-01580-14	14-01581-14
14.5cm/5¾"	



Mayo

Straight	Curved
14-01584-14	14-01585-14
14-01584-17	17.0cm/6¾"
14-01584-23	23.0cm/9"
14-01585-17	14-01585-23



Mayo-Stille

Straight	Curved
14-01588-15	14-01589-15
14-01588-17	17.0cm/6¾"
15.0cm/6"	14-01589-17



Lexer

Straight	Curved
14-01592-16	14-01593-16
16cm/6¼"	



Baby-Metzenbaum

Straight	Curved
14-01596-11	14-01597-11
11.5cm/4½"	



Metzenbaum-Fine

Straight	Curved
14-01600-14	14-01601-14
14.5cm/5¾"	



Metzenbaum-Fine

Straight	Curved
14-01604-18	14-01605-18
14-01604-20	14-01605-20
14-01604-23	14-01605-23
18cm/7"	20cm/8"
23cm/9"	

Saw edge



Sims
Straight Curved
14-01608-20 20 cm/8" 14-01609-20
14-01608-23 23 cm/9" 14-01609-23



Siebold
14-01613-24
24 cm/9½"



Jameson
16-01617-15 15 cm/6"
16-01617-18 18 cm/7"



Reynolds
Straight Curved
16-01620-15 16-01621-15
15 cm/6"



Straight Curved
14-01624-11 14-01625-11
11.5 cm/4½"



Straight Curved
14-01628-11 14-01629-11
11.5 cm/4½"



Plastic Surgery
Straight Curved
14-01632-12 14-01633-12
12 cm/4¾"



Wagner
Straight Curved
14-01636-12 14-01637-12
12 cm/4¾"

Saw Edge

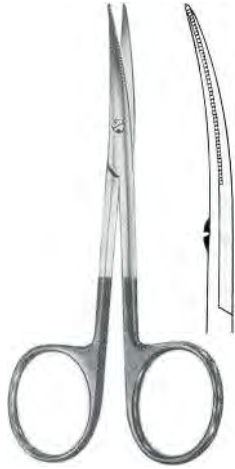

14-01641-11
11.5 cm/4½"



14-01645-14
14cm/5½"



Reynolds
14-01649-13
13cm/5"

Enderectomy Scissors



Potts-Smith
19cm/7½"

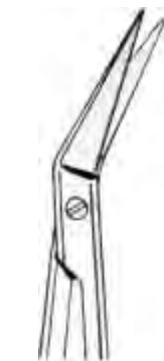

25°
14- 01653-19



45°
14- 01655-19



60°
14- 01657-19



14-01661-17
17cm/6¾"



Lister
14-01665-14 14.5cm/5¾"
14-01665-18 18cm/7"
14-01665-20 20cm/8"



Braun-Stadler
14-01669-14 14.5cm/5¾"
14-01669-22 22cm/8¾"



Stevens
Straight 14-01672-11 11.5cm/4½"
Curved 14-01673-11

Saw edge



Heymann
14-01677-18
18cm/7"



Fomon
14-01681-13
13cm/5"



Fomon
14-01685-13
13cm/5"



Cottle
14-01689-16
16cm/6¼"

General Instruments Operating Scissors

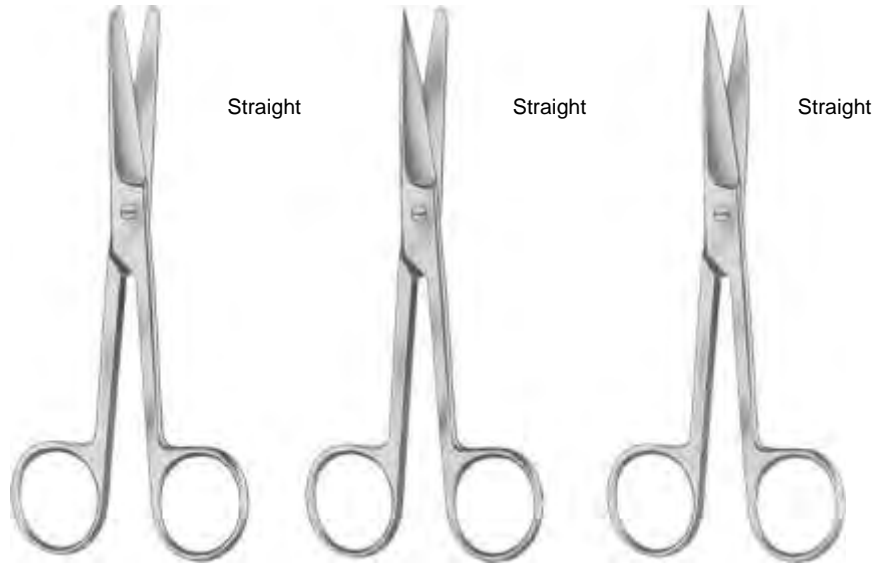

Standard
Fig. 1

Standard
Fig. 2

Standard
Fig. 3

10.0	cm/4"	14-01692-10
11.5	cm/4½"	14-01692-11
13.0	cm/5"	14-01692-13
14.5	cm/5¾"	14-01692-14
15.5	cm/6"	14-01692-15
16.0	cm/6¼"	14-01692-16
18.0	cm/7"	14-01692-18
20.0	cm/8"	14-01692-20

14-01694-10
14-01694-11
14-01694-13
14-01694-14
14-01694-15
14-01694-16
14-01694-18
14-01694-20

14-01696-10
14-01696-11
14-01696-13
14-01696-14
14-01696-15
14-01696-16
14-01696-18
14-01696-20

TC



Standard
14.5cm/5¾"



Fig. 1
14-01700-14

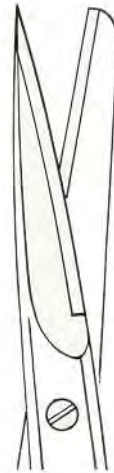

Fig. 2
14-01702-14



Fig. 3
14-01704-14



Curved

Standard
Fig. 1

14-01707-10
14-01707-11
14-01707-13
14-01707-14
14-01707-15
14-01707-16
14-01707-18
14-01707-20



Curved

Standard
Fig. 2

14-01709-10
14-01709-11
14-01709-13
14-01709-14
14-01709-15
14-01709-16
14-01709-18
14-01709-20



Curved

Standard
Fig. 3

14-01711-10
14-01711-11
14-01711-13
14-01711-14
14-01711-15
14-01711-16
14-01711-18
14-01711-20

10.0	cm/4"
11.5	cm/4½"
13.0	cm/5"
14.5	cm/5¾"
15.5	cm/6"
16.0	cm/6¼"
18.0	cm/7"
20.0	cm/8"



Curved

Standard
14.5cm/5¾"

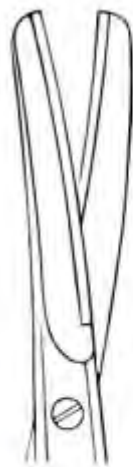

Fig. 1
14-01715-14



Fig. 2
14-01717-14



Fig. 3
14-01719-14

TC



Graziol

14-01722-13 13.0 cm/5" 14-01724-13
14-01722-14 14.5 cm/5 3/4" 14-01724-14

Straight



Graziol

14-01727-13 13.0 cm/5" 14-01729-13
14-01727-14 14.5 cm/5 3/4" 14-01729-14

Curved



Straight

14-01732-14



Curved

14-01733-14

Deaver

14.5cm/5 3/4"



Straight

14-01736-15



Curved

Mixer

15.5cm/6"

14-01737-15



Lexer
Straight
14-01740-16
16 cm/6¼"



Lexer
Curved
14-01741-16
16 cm/6¼"



Lexer
Straight
14-01744-16
16 cm/6¼"



Lexer
Curved
14-01745-16
16 cm/6¼"

TC



Lexer-Fine
Straight
14-01748-16
16 cm/6¼"



Lexer-Fine
Curved
14-01749-16
16 cm/6¼"



Lexer-Fine
Straight
14-01752-16
16 cm/6¼"



Lexer-Fine
Curved
14-01753-16
16 cm/6¼"

TC

Incision Scissors



14-01756-13 13.0 cm/5¼"
14-01756-14 14.5 cm/5¾"



14-01760-15
15.5 cm/6"



Richter
14-01763-14
14.5 cm/5¾"



Richter
14-01767-14
14.5 cm/5¾"



Fergusson
14-01771-18
18 cm/7"



New Suture
14-01775-14
14.5 cm/5¾"

TC



**Mayo
Straight**
14-01778-14 14.5 cm/5¾"
14-01778-15 15.0 cm/6"
14-01778-17 17.0 cm/6¾"
14-01778-19 19.0 cm/7½"
14-01778-23 23.0 cm/9"



**Mayo
Curved**
14-01779-14 14.5 cm/5¾"
14-01779-15 15.0 cm/6"
14-01779-17 17.0 cm/6¾"
14-01779-19 19.0 cm/7½"
14-01779-23 23.0 cm/9"



**Mayo
Straight**
14-01782-14 14.5 cm/5¾"
14-01782-18 18.0 cm/7"
14-01782-23 23.0 cm/9"



**Mayo
Curved**
14-01783-14 14.5 cm/5¾"
14-01783-18 18.0 cm/7"
14-01783-23 23.0 cm/9"

TC



**Mayo-Stille
Straight**
14-01786-15 15 cm/6"
14-01786-17 17 cm/6¾"
14-01786-19 19 cm/7½"
14-01786-21 21 cm/8¼"



**Mayo-Stille
Curved**
14-01787-15 15 cm/6"
14-01787-17 17 cm/6¾"
14-01787-19 19 cm/7½"
14-01787-21 21 cm/8¼"



**Mayo-Stille
Straight**
14-01790-15 15 cm/6"
14-01790-17 17 cm/6¾"



**Mayo-Stille
Curved**
14-01791-15 15 cm/6"
14-01791-17 17 cm/6¾"



Straight

Mayo-Noble
14-01794-17
17 cm/6¾"



Curved

Mayo-Noble
14-01795-17
17 cm/6¾"



Straight

Baby-Metzenbaum
14-01798-11
11.5 cm/4½"

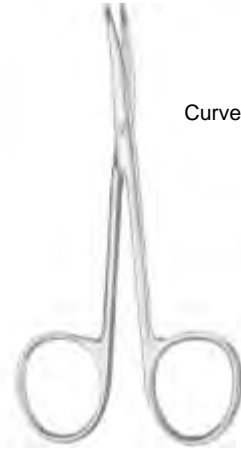

Curved

Baby-Metzenbaum
14-01799-11
11.5 cm/4½"



Metzenbaum-Fine
14-01802-14
14.5 cm/5¾"

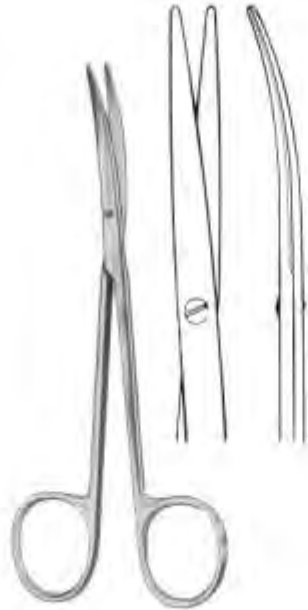

Metzenbaum-Fine
14-01803-14
14.5 cm/5¾"



Metzenbaum-Fine
14-01806-14
14.5 cm/5¾"



Metzenbaum-Fine
14-01807-14
14.5 cm/5¾"

Straight



Fig 1

Metzenbaum
14-01810-14
14.5 cm/5¾"



Fig 2

Metzenbaum
14-01812-14
14.5 cm/5¾"

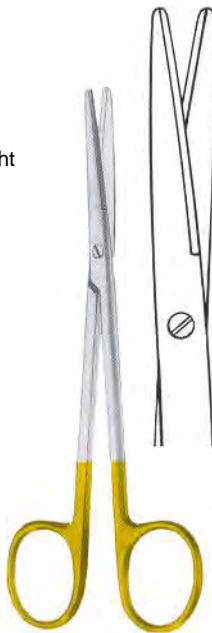

Fig 3

Metzenbaum
14-01814-14
14.5 cm/5¾"

TC

Straight



Metzenbaum
14-01818-14
14.5 cm/5¾"

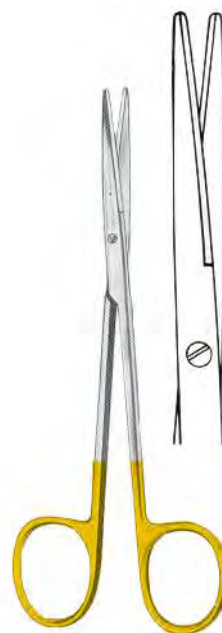

Metzenbaum-Fine
14-01820-14
14.5 cm/5¾"

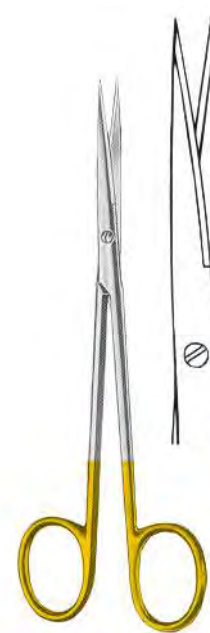

Metzenbaum-Fine
14-01822-14
14.5 cm/5¾"

Curved



Fig. 1
Metzenbaum
14-01825-14
14.5 cm/5¾"



Fig. 2
Metzenbaum
14-01827-14
14.5 cm/5¾"



Fig. 3
Metzenbaum
14-01829-14
14.5 cm/5¾"

TC

Curved



Metzenbaum
14-01831-14
14.5 cm/5¾"



Metzenbaum-Fine
14-01833-14
14.5 cm/5¾"



Metzenbaum-Fine
14-01835-14
14.5 cm/5¾"

Straight



	Metzenbaum-Fine	Metzenbaum	Metzenbaum	Metzenbaum
18 cm/7"	14-01838-18	14-01840-18	14-01842-18	14-01844-18
20 cm/8"	14-01838-20	14-01840-20	14-01842-20	14-01844-20
23 cm/9"	14-01838-23	14-01840-23	14-01842-23	14-01844-23
25 cm/10"	14-01838-25	14-01840-25	14-01842-25	14-01844-25
28 cm/11"	14-01838-28	14-01840-28	14-01842-28	14-01844-28
30 cm/12"	14-01838-30	14-01840-30	14-01842-30	14-01844-30

TC
Straight



	Metzenbaum	Metzenbaum-Fine	Metzenbaum-Fine
18 cm/7"	14-01848-18	14-01850-18	14-01852-18
20 cm/8"	14-01848-20	14-01850-20	14-01852-20
23 cm/9"	14-01848-23	14-01850-23	14-01852-23
25 cm/10"	14-01848-25	14-01850-25	14-01852-25
28 cm/11"	14-01848-28	14-01850-28	14-01852-28
30 cm/12"	14-01848-30	14-01850-30	14-01852-30

Curved



	Metzenbaum-Fine	Metzenbaum	Metzenbaum	Metzenbaum
18 cm/7"	14-01855-18	14-01857-18	14-01859-18	14-01861-18
20 cm/8"	14-01855-20	14-01857-20	14-01859-20	14-01861-20
23 cm/9"	14-01855-23	14-01857-23	14-01859-23	14-01861-23
25 cm/10"	14-01855-25	14-01857-25	14-01859-25	14-01861-25
28 cm/11"	14-01855-28	14-01857-28	14-01859-28	14-01861-28
30 cm/12"	14-01855-30	14-01857-30	14-01859-30	14-01861-30

TC

Curved



	Metzenbaum	Metzenbaum-Fine	Metzenbaum-Fine
18 cm/7"	14-01865-18	14-01867-18	14-01869-18
20 cm/8"	14-01865-20	14-01867-20	14-01869-20
23 cm/9"	14-01865-23	14-01867-23	14-01869-23
25 cm/10"	14-01865-25	14-01867-25	14-01869-25
28 cm/11"	14-01865-28	14-01867-28	14-01869-28
30 cm/12"	14-01865-30	14-01867-30	14-01869-30



Sims
14-01870-20 20 cm/8"
14-01870-23 23 cm/9"



Straight
14-01872-20 20 cm/8" 14-01874-20
14-01872-23 23 cm/9" 14-01874-23



Sims
14-01977-20 20 cm/8"
14-01977-23 23 cm/9"



Curved
14-01879-20 20 cm/8" 14-01881-20
14-01879-23 23 cm/9" 14-01881-23

TC



Sims
14-01883-20 20 cm/8"
14-01883-23 23 cm/9"



Wertheim
14-01887-14 14.5 cm/5¾"
14-01887-19 19.5 cm/7¾"
14-01887-22 22.5 cm/9"



Curved

Dubois
14-01892-27 27 cm/10½"



Dubois
14-01893-27 27 cm/10½"



Straight

Doyen
14-01896-16 16 cm/6¼"
14-01896-18 18 cm/7"

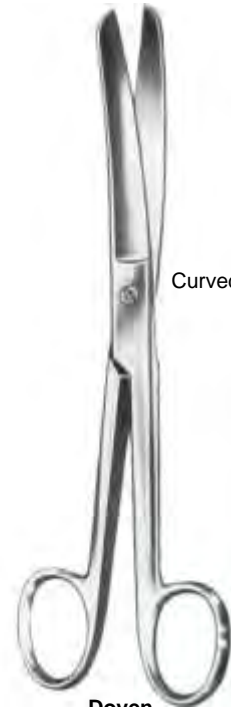

Curved

Doyen
14-01897-16 16 cm/6¼"
14-01897-18 18 cm/7"



Kelly
14-01900-16 16 cm/6¼"
14-01900-18 18 cm/7"



Kelly
14-01901-16 16 cm/6¼"
14-01901-18 18 cm/7"



Fig. 1
14-01904-12

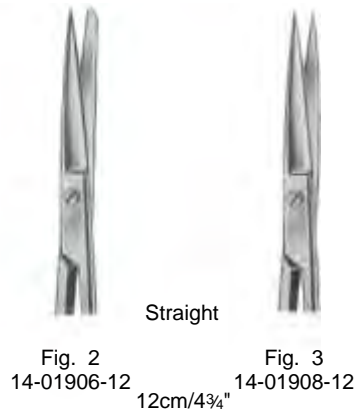

Fig. 2 14-01906-12
12cm/4¾"

Fig. 3 14-01908-12

Straight



Fig. 1
14-01911-12

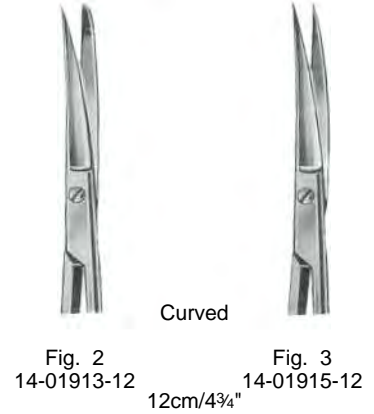
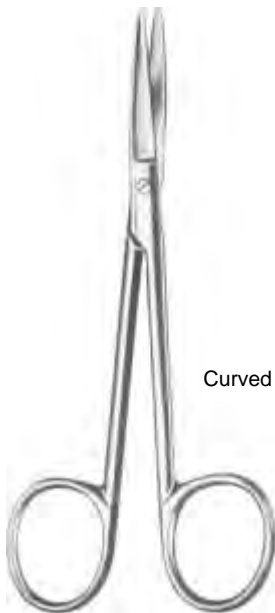

Fig. 2 14-01913-12
12cm/4¾"

Fig. 3 14-01915-12

Curved

Saw Edge



Wagner
12cm/4¾"

Curved



Fig. 1 14-01916-12
Fig. 2 14-01918-12
Fig. 3 14-01920-12
Fig. 4 14-01922-12

Straight

Curved



Fig. 1 14-01923-12
Fig. 2 14-01925-12
Fig. 3 14-01927-12
Fig. 4 14-01929-12



14-01932-12
11.5cm/4½"



14-01933-12
11.5cm/4½"



Straight

Brophy (Sullivan)
14-01936-14

14.5 cm/5¾"



Curved

14-01937-14



Straight

Reynolds
14-01940-15
14-01940-18

15 cm/6"
18 cm/7"



Curved

14-01941-15
14-01941-18

Enucleation Scissors



Jameson
14-01945-15
15cm/6"



14-01948-12



14-01951-12



14-01953-12



14-01955-12

Landolt
12.5cm/5"



9.0 cm/3½"	14-01958-09	14-01959-09	14-01961-09	14-01964-09	14-01965-09
10.5 cm/4¼"	14-01958-10	14-01959-10	14-01961-10	14-01964-10	14-01965-10
11.5 cm/4½"	14-01958-11	14-01959-11	14-01961-11	14-01964-11	14-01965-11

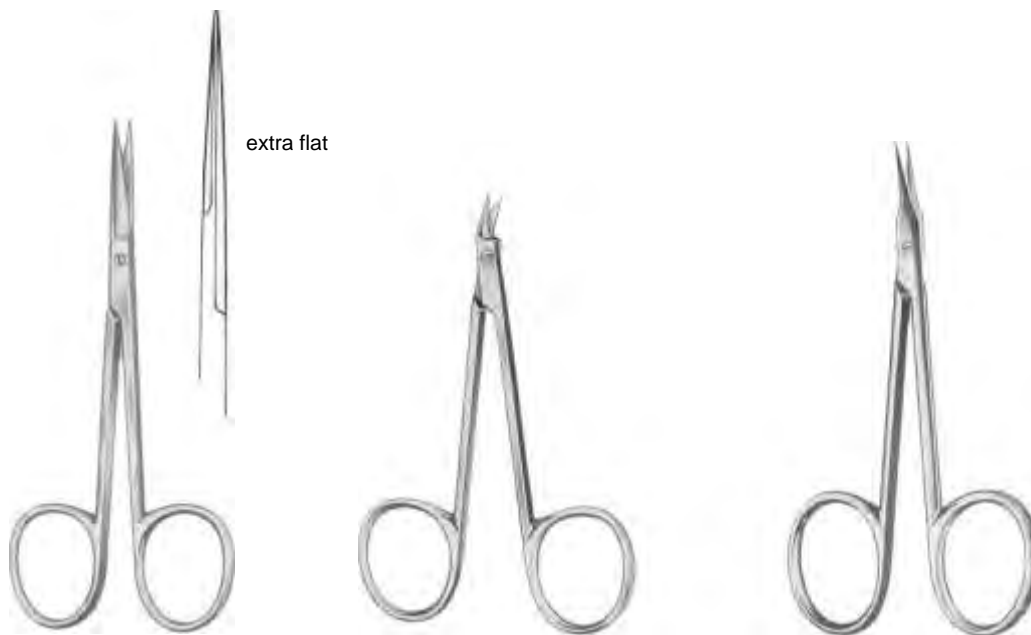

14-01968-10
10cm/4"

14-01971-09
9cm/3½"

Walton
14-01975-10
10cm/4"



Straight

14-01978-14

Sanvenero
14.5cm/5¾"

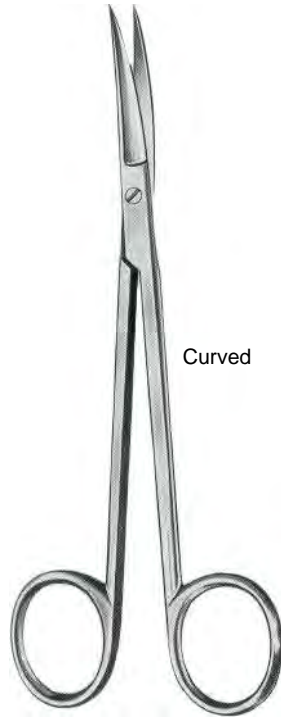

Curved

14-01979-14



Straight

14-01982-10

Baby-Lexer (Knapp)
10cm/4"

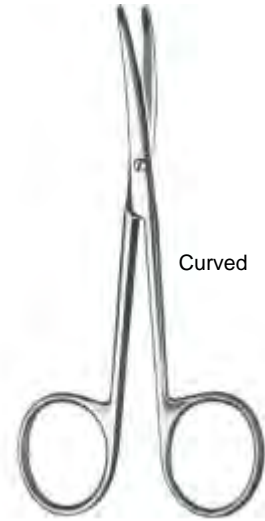

Curved

14-01983-10



Straight
14-01986-13 13cm/5"

Curved
14-01987-13



Straight

14-01990-14

Joseph
14cm/5½"

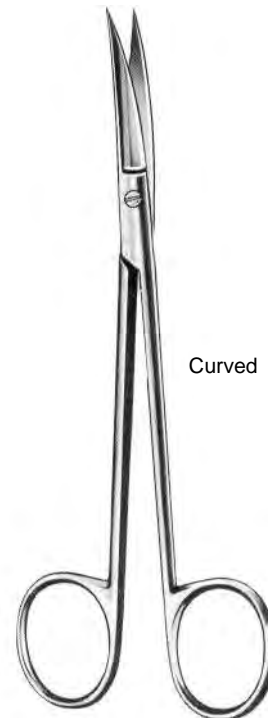

Curved

14-01991-14



Kilner (Ragnell)
14-01995-12 12cm/4¾"
14-01995-13 13cm/5"
14-01995-15 15cm/6"



14-01998-14
14.5cm/5¾"

Coronary Scissors

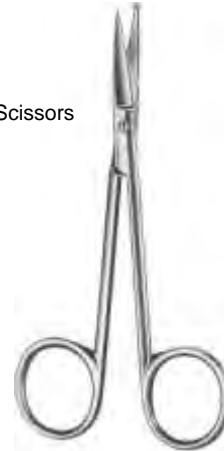

14-02002-11
11.5cm/4½"



Potts-Smith
14-02005-19
19.5cm/7¾"



De Bakey
14-02009-15
15.5cm/6"



De Bakey
14-02013-15
15.5cm/6"



Favaloro
14-02017-15
15cm/6"

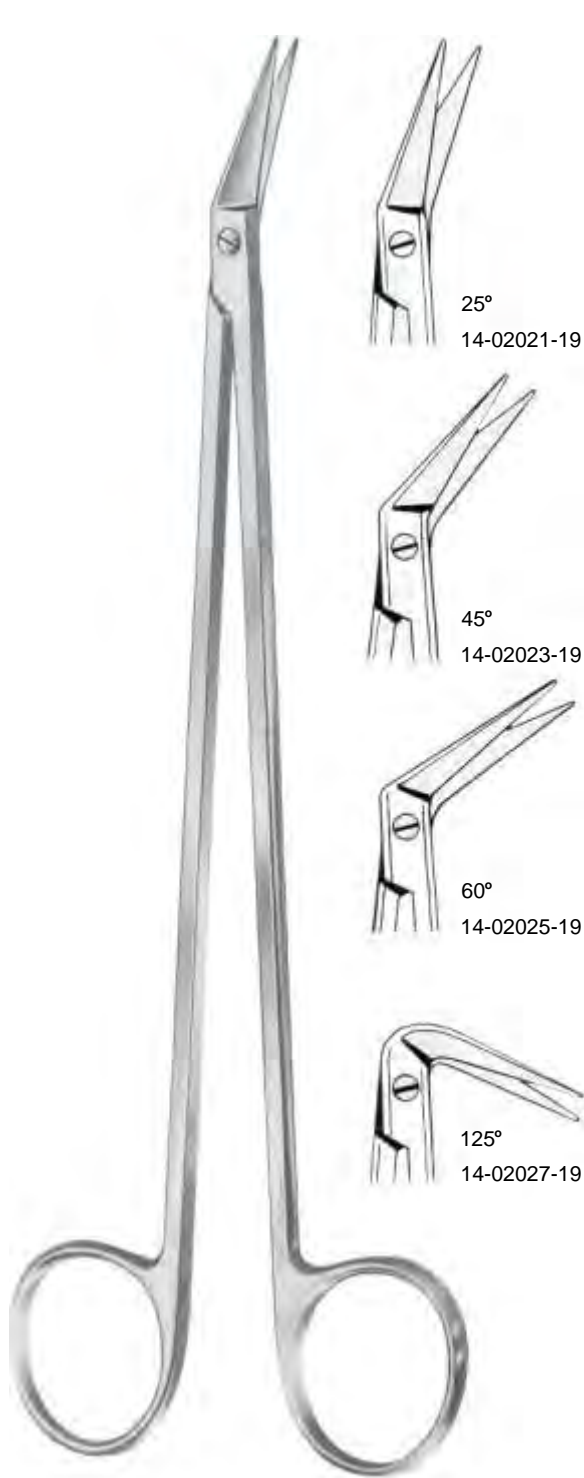

Potts-Smith
19cm/7½"

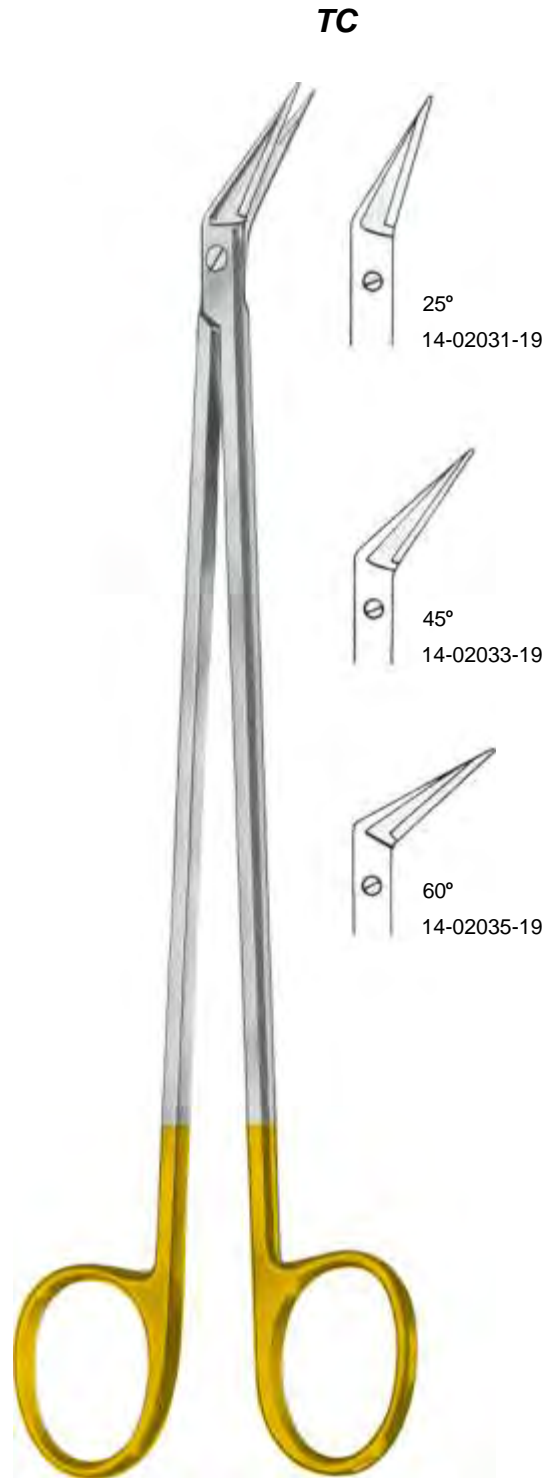

Potts-Smith
19cm/7½"



Saw Edge

Martin-Cartilage
14-02039-20
20cm/8"



McIndoe
14-02042-19
19cm/7½"



Potts-Smith
14-02045-19
19cm/7½"



Satinsky
14-02049-24
24.5cm/10"



Klingenberg-Loth
14-02053-23
23cm/9"



De Bakey
18cm/7"

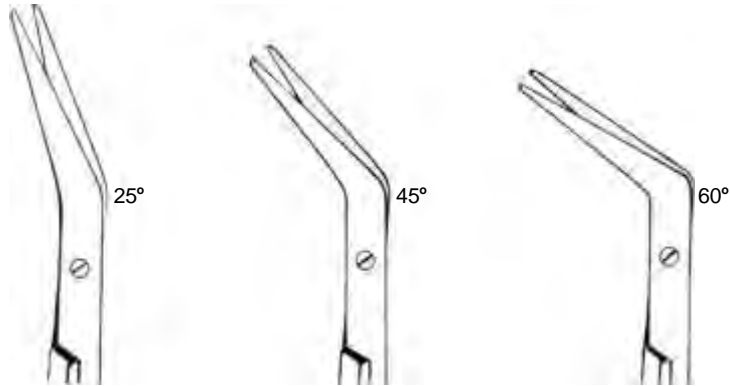

cm	In			
16.0cm	6¼"	14-02057-16	14-02059-16	14-02061-16
23.0cm	9"	14-02057-23	14-02059-23	14-02061-23
28.0cm	11"	14-02057-28	14-02059-28	14-02061-28



Baby-Hegemann
13.5cm/5¼"

Hegemann (Diethrich)
16cm/6¼"
19cm/7½"

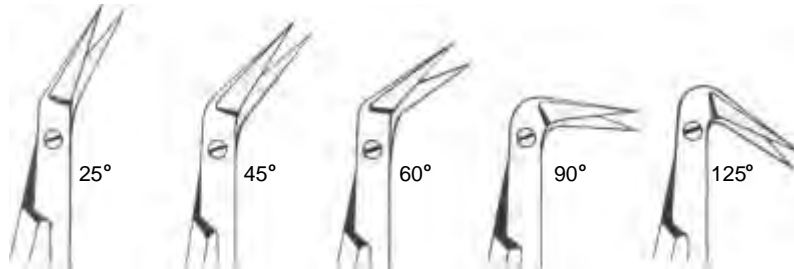

cm	In					
13.0cm	5¼"	14-02063-13	14-02065-13	14-02067-13	14-02069-13	14-02071-13
16.0cm	6¼"	14-02063-16	14-02065-16	14-02067-16	14-02069-16	14-02071-16
19.0cm	7½"	14-02063-19	14-02065-19	14-02067-19	14-02069-19	14-02071-19



Hegemann (Diethrich)
14-02075-19
19cm/7½"



18cm/7"

25°



14-02079-18

45°



14-02081-18

60°



14-02083-18

90°



14-02085-18

125°



14-02087-18

25°



14-02091-18

45°



14-02093-18

60°



14-02095-18

90°



14-02097-18

125°



14-02099-18

Nerve Dissecting Scissors



14-02103-15
15cm/6"

Tonsil Scissors



Bottcher
14-02107-18
18cm/7"



Prince
14-02111-17
17.5cm/7"

Arteriotomy Scissors



Tonnis-Adson-Fine
14-02115-17
17.5cm/7"



Straight

Tonnis
14-02118-18
18cm/7"

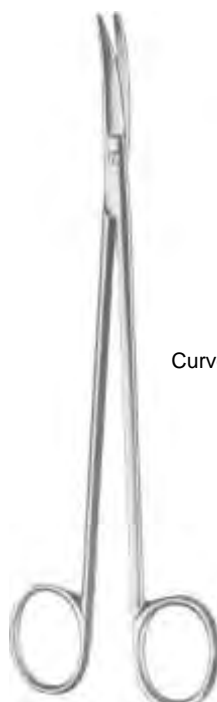

Curved

Tonnis
14-02119-18
18cm/7"



Tonnis-Adson
14-02123-17
17.5cm/7"

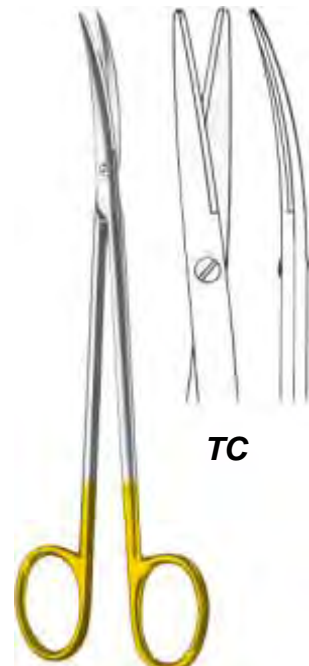

TC

Tonnis-Adson
14-02125-17
17.5cm/7"

Tonsil Scissors



Good
14-02129-19
19 cm/7½"

Lobectomy Scissors



Crafoord
14-02133-30
30 cm/12"



Finochietto
14-02137-27
27 cm/10½"

Enterotomy Scissors



14-02142-21
21 cm/8¼"



14-02146-21
21 cm/8¼"



14-02150-21
21 cm/8¼"



Busch
14-02153-13 13 cm/5"
14-02153-16 16 cm/6¼"



Schumacher
14-02157-16
16 cm/6¼"



Mod. USA
14-02160-10
10.5 cm/4¼"



Braun-Stadler
14-02163-14
14 cm/5½"



Braun-Stadler
14-02165-22
22 cm/8½"



14-02169-23
23 cm/9"

14-02171-23
23 cm/9"

TC



Heymann
14-02175-18
18 cm/7"



Heymann
14-02177-19
19.5 cm/7¾"



Knight
14-02181-18
18 cm/7"



Fomon
14-02185-13
13 cm/5"



Fomon
14-02189-13
13.5 cm/5¼"



Fomon
14-02191-13
13.5 cm/5¼"



Cottle
14-02195-16
16 cm/6¼"



Halle
14-02199-19
19 cm/7¼"

General Instruments

Dissecting, Trigeminal, Wire Cutting
and Gum Scissors



Strully
14-02202-22 22 cm/8¾" 14-02203-22



Dandy
14-02207-22
17 cm/6¾"

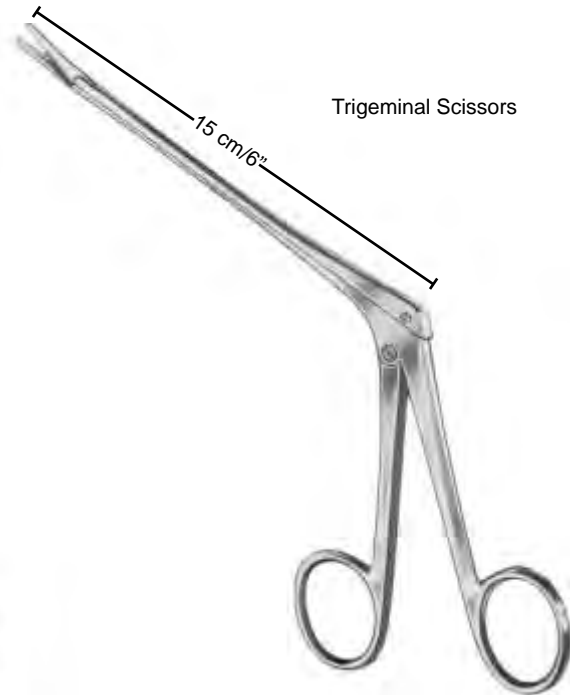

Trigeminal Scissors

Olivecrona
14-02211-15

TC



Universal
14-02215-12
12 cm/4¾"



Goldman-Fox
Straight
14-02218-13
13 cm/5"



Goldman-Fox
Curved
14-02219-13
13 cm/5"



Fig. 1



Fig. 2



Fig. 3

Noyes
Fig.1 14-02222-01
Fig.2 14-02222-02
Fig.3 14-02222-03
12 cm/4¾"



Noyes
14-02225-12
12 cm/4¾"



14-02229-01

14-02229-02

Wecker
11.5 cm/4½"



Barraquer
14-02233-05
5.5 cm/2¼"



14-02236-09
9 cm/3½"



14-02238-09



14-02240-09



14-02243-09



14-02245-09



14-02247-09



Straight

Vannas
14-02250-08
8 cm/3¼"



Curved

Vannas
14-02253-08
8 cm/3¼"



Angular

Vannas
14-02255-08
8 cm/3¼"



Vannas
14-02257-08
8 cm/3¼"



Straight

14-02260-08
8.5 cm/3¼"



Curved

Vannas Mod, Tubingen
14-02263-08
8.5 cm/3½"



Angular

14-02265-08
8.5 cm/3½"



Angular

14-02267-08
8.5 cm/3½"



14-02270-10
10 cm/4"



14-02271-10
10 cm/4"



Castroviejo
14-02273-10
10 cm/4"



Castroviejo
14-02275-10
10 cm/4"



Aebli
14-02277-10
10 cm/4"



Castroviejo
14-02281-10
10 cm/4"



Castroviejo
14-02283-10
10 cm/4"



Troutman-Barraquer
14-02285-10
10 cm/4"

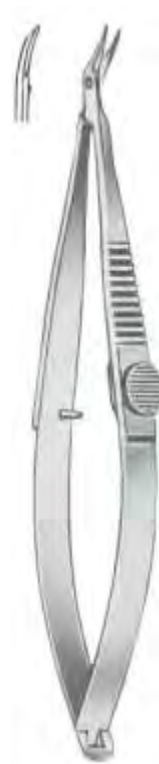

Troutman-Barraquer
14-02287-10
10 cm/4"



Troutman
14-02291-10
10 cm/4"



Troutman
14-02293-10
10 cm/4"



Katzin-Barraquer
14-02295-10
10 cm/4"



Katzin-Barraquer
14-02297-10
10 cm/4"



Katzin
14-02301-11
10 cm/4"



Katzin
14-02303-11
10 cm/4"



Westcott
14-02307-11
11 cm/4½"



Westcott
14-02309-11
11 cm/4½"



Westcott
14-02311-11
11 cm/4½"



Castroviejo
14-02315-10
10 cm/4"



Castroviejo
14-02317-10
10 cm/4"



Castroviejo
14-02321-11
11.5 cm/4½"



Castroviejo
14-02323-11
11.5 cm/4½"



Troutmann-Castroviejo
14-02327-10
10.5 cm/4¼"



Troutmann-Castroviejo
14-02329-10
10.5 cm/4¼"



Straight
14-02332-14
14-02332-18

Curved
14-02333-14
14-02333-18



Straight

14-02336-12 12.0 cm/4¾"
14-02336-16 16.0 cm/6¼"
14-02336-18 18.5 cm/7¼"



Curved

14-02337-12 12.0 cm/4¾"
14-02337-16 16.0 cm/6¼"
14-02337-18 18.5 cm/7¼"

**Vannas
Straight**

14-02340-12 12.0 cm/4¾"
14-02340-16 16.0 cm/6¼"

**Vannas
Curved**

14-02341-12 12.0 cm/4¾"
14-02341-16 16.0 cm/6¼"



Yasargil

20.0cm/8"

16.5cm/6½"
20.0cm/8"



Straight
14-02344-16
14-02344-20



Curved
14-02345-16
14-02345-20



Curved Downwards
14-02347-20

20.0cm/8"

Dissecting Scissors



Straight
14-02350-20



Curved
14-02351-20

General Instruments Micro Scissors



Yasargil

22.5cm/9"
24.5cm/9¾"



Straight
14-02354-22
14-02354-24



Curved
14-02355-22
14-02355-24



Curved Downwards
14-02357-22

22.5cm/9"

Dissecting Scissors



Straight
14-02360-22



Curved
14-02361-22

22.5cm/9"



Jacobson
18cm/7"

14-02364-18



14-02370-19

14-02365-18



14-02371-19

14-02367-18



14-02373-19

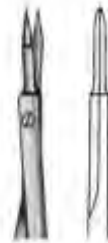

14-02376-19



14-02377-19



19cm/7 1/2"

Vein Scissors



Straight
14-02384-12
12cm/4¾"



Curved
14-02385-12
12cm/4¾"



Straight
14-02392-12
12cm/4¾"



Curved
14-02393-12
12cm/4¾"



Angled up
14-02395-12
12cm/4¾"

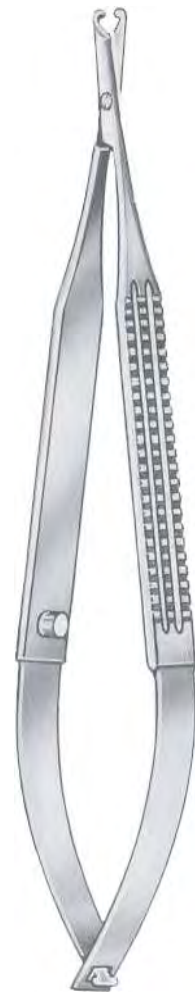

Straight
14-02400-13
13cm/5 1/8"



Saw Edge



Straight
14-02404-16
16cm/6¼"



Curved
14-02405-16
16cm/6¼"



Straight
14-02408-16
16cm/6¼"

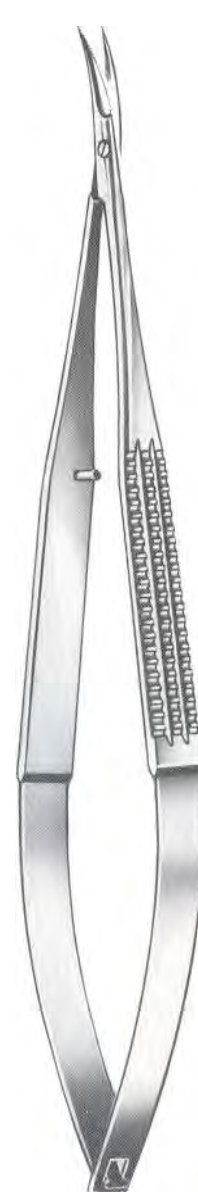

Curved
14-02409-16
16cm/6¼"



Millesi
Straight
14-02412-16
16cm/6¼"



Millesi
Curved
14-02413-16
16cm/6¼"



Straight
14-02416-18
18.5cm/7¼"



Curved
14-02417-18
18.5cm/7¼"



Angular
14-02421-18
18.5cm/7¼"

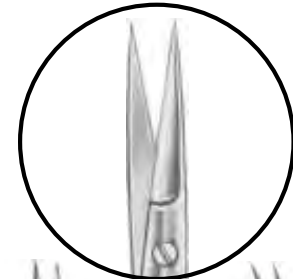

Saw Edge



Straight
14-02424-16
16cm/6¼"



Curved
14-02425-16
16cm/6¼"



Straight
14-02428-16
16cm/6¼"



Curved
14-02429-16
16cm/6¼"



Straight
14-02432-16
16cm/6¼"



Curved
14-02433-16
16cm/6¼"



Straight
14-02436-18
18.5cm/7¼"



Curved
14-02437-18
18.5cm/7¼"



Angular
14-02441-18
18.5cm/7¼"



Straight
14-02444-23
23cm/9"

Dissecting Scissors



Straight
14-02448-14
14.5cm/5¾"



Curved
14-02449-14
14.5cm/5¾"



Curved
14-02451-14
14.5cm/5¾"



TC





Straight

Curved

Standard

9.0 cm/3½"	14-02482-09	14-02483-09	14-02485-09	14-02487-09
10.5 cm/4¼"	14-02482-10	14-02483-10	14-02485-10	14-02487-10
11.5 cm/4½"	14-02482-11	14-02483-11	14-02485-11	14-02487-11



Straight

Curved

Straight

Curved

Fine

Fine

9.0cm/3¾"			14-02496-09	14-02497-09
10.5cm/4¼"	14-02492-10	14-02493-10	14-02496-10	14-02497-10
11.5cm/4½"	14-02492-11	14-02493-11	14-02496-11	14-02497-11

General Instruments Eye Scissors



Straight
Fine

9.5 cm/3¾"	14-02500-09
10.5 cm/4¼"	14-02500-10
11.5 cm/4½"	14-02500-11



Curved
Fine

14-02501-09
14-02501-10
14-02501-11



Straight

14-02504-10 10cm/4"

Curved

14-02505-10

Tenotomy Scissors



10.5cm/4¼"
11.5cm/4½"



Pointed

Straight
14-02508-10
14-02508-11



Curved

14-02509-10
14-02509-11



Blunt

Straight
14-02512-10
14-02512-11



Curved

14-02513-10
14-02513-11



Straight
14-02516-08



Bonn
8cm/3¼"

Curved
14-02517-08



Graefe
14-02520-10
10.5cm/4¼"



Wilmer
14-02521-10
10cm/4"



14-02524-11



11.5cm/4½" 14-02525-11

TC



Straight
14-02528-11



Curved
14-02529-11
11.5cm/4½"



La Grange
14-02532-11
11.5cm/4½"



Chadwick
14-02533-11
11cm/4½"

Neurosurgical Scissors

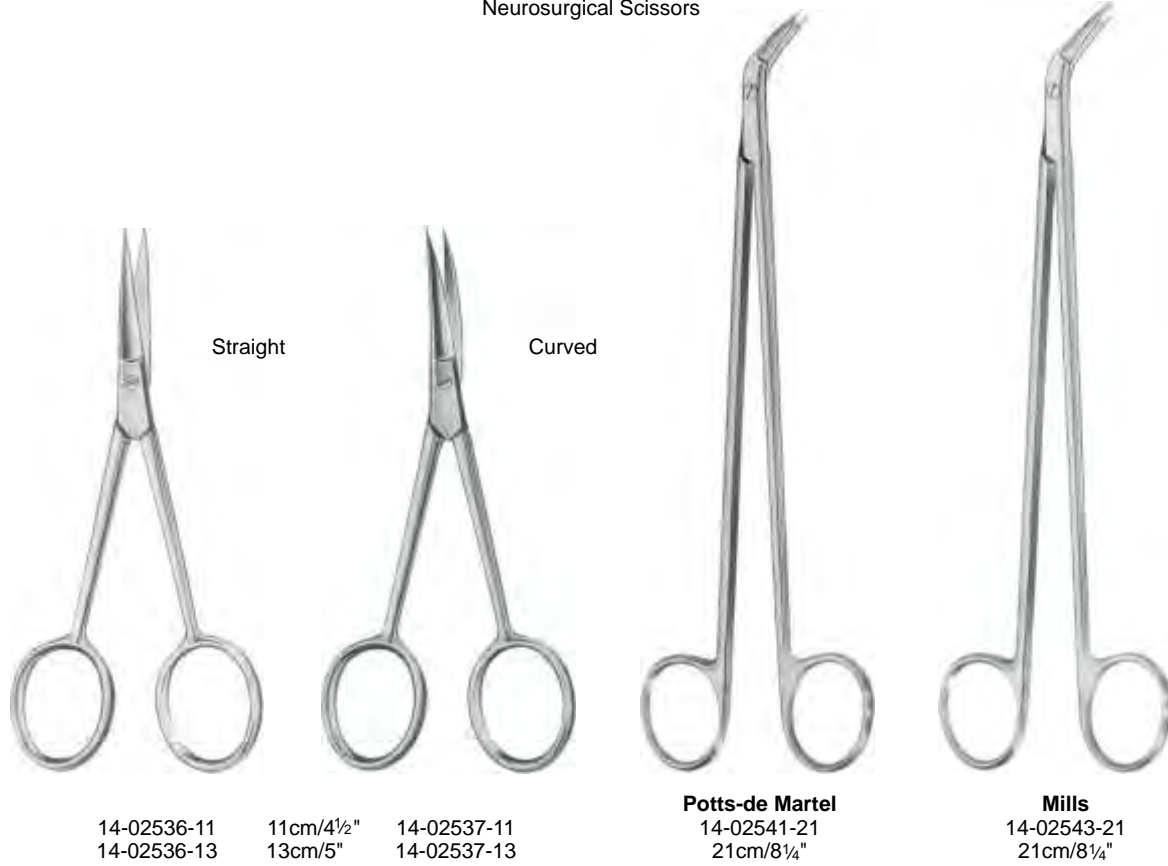



Littauer
14-02559-14
14cm/5½"



Spencer
14-02563-09
9cm/3½"



Spencer
14-02565-10 10.5cm/4¼"
14-02565-12 12.0cm/4¾"



Spencer-Fine
14-02567-11 11.5cm/4½"
14-02567-16 16cm/6¼"



Shortbent
14-02571-09
9cm/3½"



Northbent
14-02575-12
12.5cm/5"



Spencer
14-02579-11
11.5cm/4½"



Littler
14-02583-11
11.5cm/4½"



Heath
14-02587-15
15cm/6"



14-02591-10
10cm/4"



Eiselsberg
14-02595-11
11.5cm/4½"



Schoemaker-Loth
14-02599-12
12.5cm/5"

Wire Cutting Scissors



Universal
14-02603-12
12cm/4¾"

Saw Edge



	Universal
Black	14-02607-01
Blue	14-02607-02
Red	14-02607-03
Green	14-02607-04

14.5 cm/5¾"



	Universal
	14-02609-01
	14-02609-02
	14-02609-03
	14-02609-04

16 cm/6¼"



	Universal
	14-02611-01
	14-02611-02
	14-02611-03
	14-02611-04

18 cm/7"

Nail Splitting Scissors



Smith
14-02615-17
17.5 cm/7"



Harvey
14-02618-12
12.5 cm/5"

Saw edge

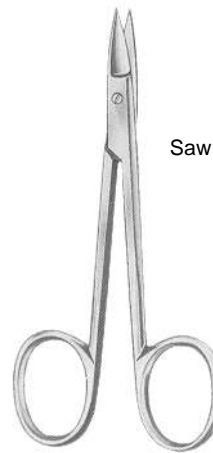

Schuknecht
14-02622-10
10 cm/4"

Saw edge



14-02626-13 13 cm/5"
14-02626-15 15 cm/6"

TC



Lister

14-02629-09 09.0 cm/3½"
14-02629-11 11.5 cm/4½"
14-02629-14 14.0 cm/5½"
14-02629-15 15.5 cm/6"
14-02629-18 18.0 cm/7"
14-02629-20 20.0 cm/8"



Lister

14-02631-18
18 cm/7"



Lister

14-02633-18 18.5 cm/7¼"
14-02633-21 21.0 cm/8¼"



Lister-Excentric

14-02637-16 16 cm/6¼"
14-02637-19 19 cm/7½"



Esmarch

14-02641-20 20 cm/8"
14-02641-22 22 cm/8¾"



Bergmann

14-02645-23
23 cm/9"



Lorenz

14-02649-23
23 cm/9"



Saw edge

14-02653-17
17 cm/6¾"



Lange
14-02657-18
18 cm/7"



Bruns
14-02661-24 24 cm/9½" Saw edge
14-02663-24 24 cm/9½" Smooth
14-02667-24 24 cm/9½" TC



Smith (Mod. USA)
14-02671-18 18 cm/7"
14-02671-20 20 cm/8"
14-02671-23 23 cm/9"



Knowles
14-02674-14
14 cm/5½"



Knowles
14-02675-14
14 cm/5½"



14-02679-13
13 cm/5"



14-02683-20
20 cm/8"



Seutin
14-02687-23
23 cm/9"



14-2691-23
23 cm/9"



Collin
14-02695-22
22 cm/8¾"



Gluck
14-02699-22
22 cm/8¾"



Stille
14-02701-21
21 cm/8¼"



Stille
14-02703-24
24 cm/9½"



Stille
14-02705-23 23 cm/9"
14-02705-26 26 cm/10¼"
14-02705-37 37 cm/14½"

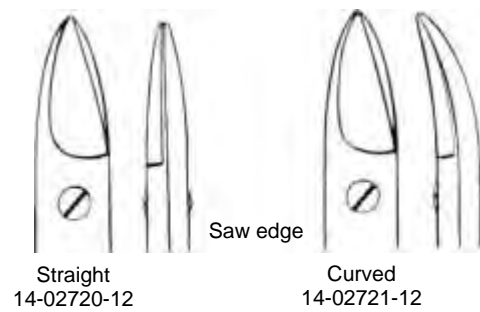
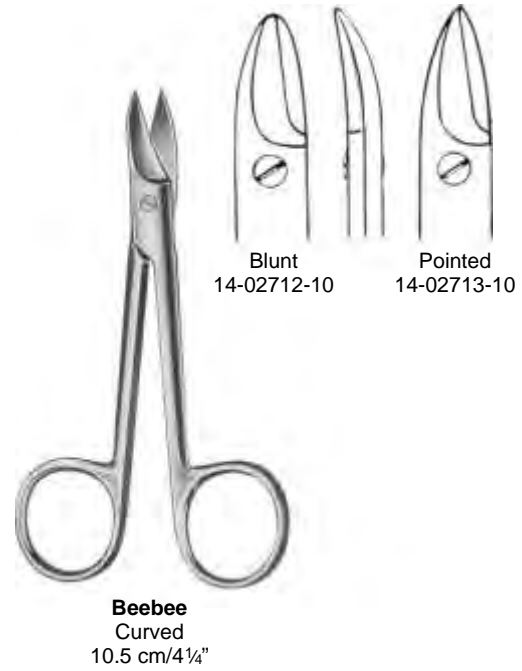
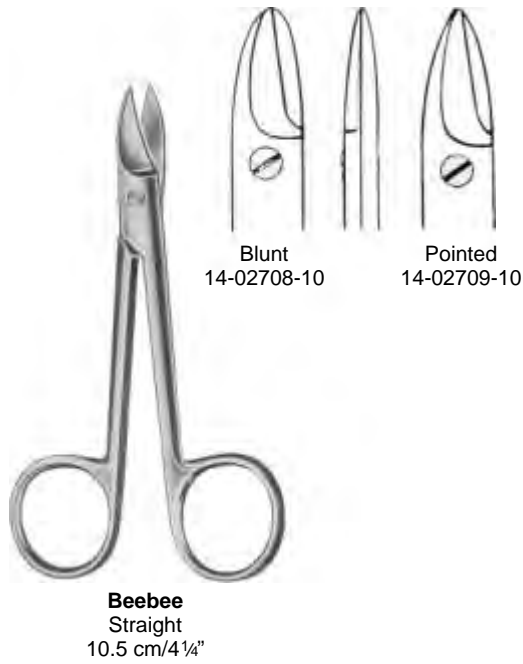



Goldmann-Fox
14-02724-13
13 cm/5"

Saw edge



Goldmann-Fox
14-02725-13
13 cm/5"



Niro
14-02729-14
14 cm/5 1/2"



**Goldmann-Fox
(Spezial)**
14-02733-13
13 cm/5"

Saw edge



14-02737-11
11.5 cm/4 1/2"

Fine



Quinby
14-02740-12
12 cm/4 3/4"



Quinby
14-02741-12
12 cm/4 3/4"



Saw edge

Dean
14-02745-17
17 cm/6¾"



Dean
14-02747-17
17 cm/6¾"



Saw edge

Locklin
14-02751-16
16.5 cm/6½"

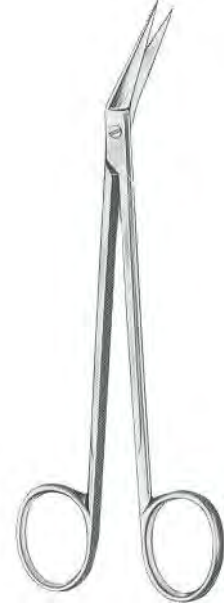

Locklin
14-02753-16
16.5 cm/6½"



Saw edge

Sullivan
14-02758-14
14.5 cm/5¾"



Sullivan
14-02759-14
14.5 cm/5¾"



Neumann
14-02763-12
12.5 cm/5"



Saw edge

La Grange
14-02765-11
11.5 cm/4½"



14-02768-11	Standard 11.5 cm/4½"	14-02769-11	14-02772-11	Standard 11.5 cm/4½"	14-02773-11	Chadwick 11.5 cm/4½"
-------------	--------------------------------	-------------	-------------	--------------------------------	-------------	--------------------------------

Nail scissors



09.0 cm/3½"	14-02780-09	14-02781-09	14-02784-09	14-02785-09
10.5 cm/4¼"	14-02780-10	14-02781-10	14-02784-10	14-02785-10

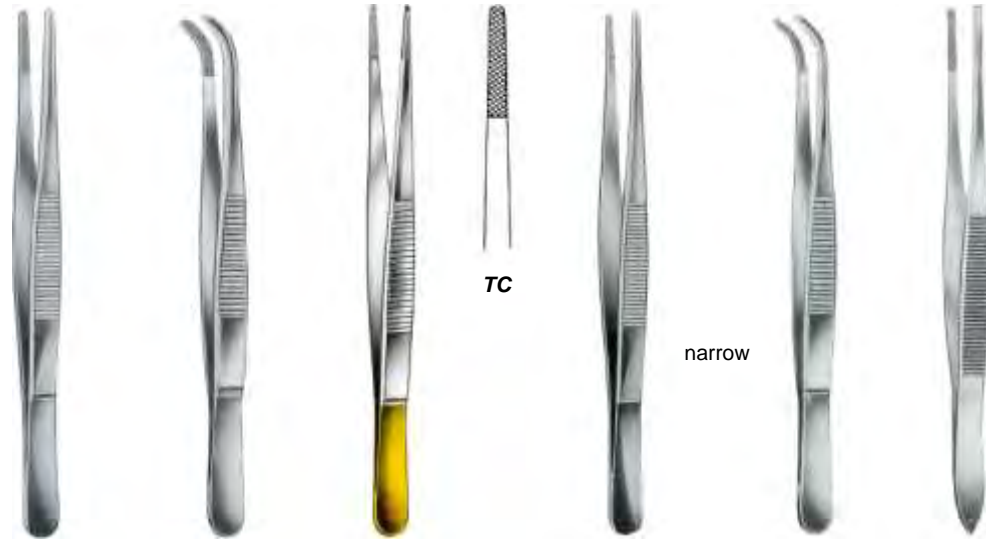

cm	in	Standard	Standard	Standard			Stille
10.5	4 1/4"	15-02788-10					
11.5	4 1/2"	15-02788-11	15-02789-11		15-02796-11	15-02797-11	
13.0	5"	15-02788-13	15-02789-13		15-02796-13	15-02797-13	15-02802-13
14.5	5 3/4"	15-02788-14	15-02789-14	15-02792-14	15-02796-14	15-02797-14	
15.0	6"	15-02788-15					15-02802-15
16.0	6 1/4"	15-02788-16	15-02789-16	15-02792-16	15-02796-16	15-02797-16	
17.0	6 3/4"						15-02802-17
18.0	7"	15-02788-18	15-02789-18	15-02792-18	15-02796-18	15-02797-18	
20.0	8"	15-02788-20	15-02789-20	15-02792-20	15-02796-20	15-02797-20	15-02802-20
25.0	10"	15-02788-25	15-02789-25	15-02792-25	15-02796-25	15-02797-25	
30.0	12"	15-02788-30	15-02789-30		15-02796-30	15-02797-30	

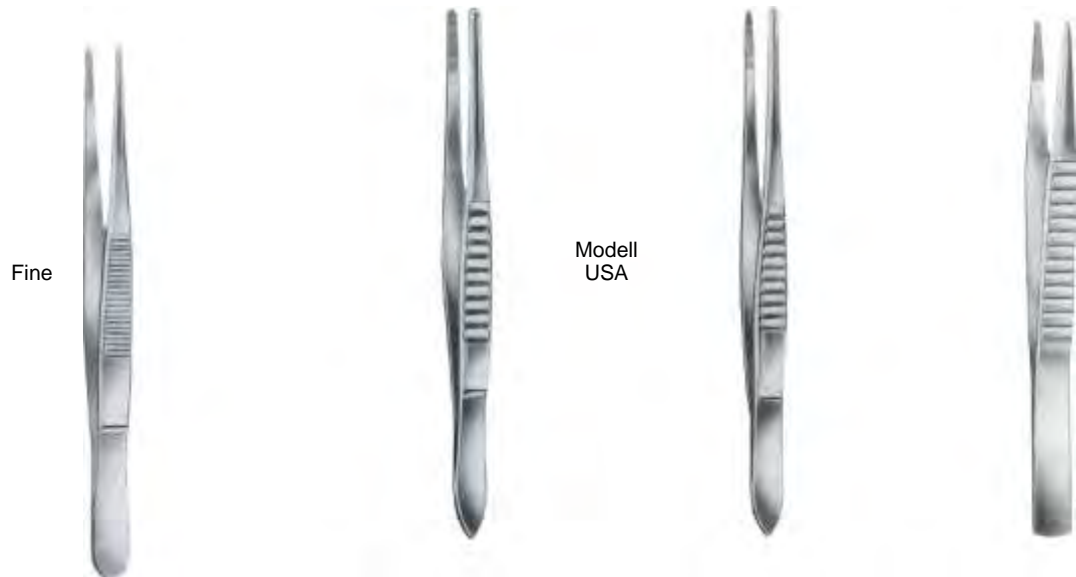

cm	in		Standard	Narrow	Engl. Modell
11.5	4 1/2"	15-02806-11			
12.0	4 3/4"		15-02810-12	15-02814-12	
13.0	5"	15-02806-13	15-02810-13	15-02814-13	15-02818-13
14.5	5 3/4"	15-02806-14	15-02810-14	15-02814-14	15-02818-14
15.0	6"	15-02806-15	15-02810-15	15-02814-15	15-02818-15
16.0	6 1/4"	15-02806-16			
18.0	7"	15-02806-18	15-02810-18		
20.0	8"	15-02806-20			
21.0	8 1/4"		15-02810-21		
25.0	10"		15-02810-25		
30.0	12"		15-02810-30		

General Instruments Dressing Forceps



cm	in	Ewald	Jacobson-Adson	Micro-Adson	Adson-Standard	Adson
12.0	4¾"	15-02822-12	15-02826-12	15-02830-12	15-02834-12	15-02838-12
15.5	6"	15-02822-15	15-02826-15	15-02830-15	15-02834-15	15-02838-15

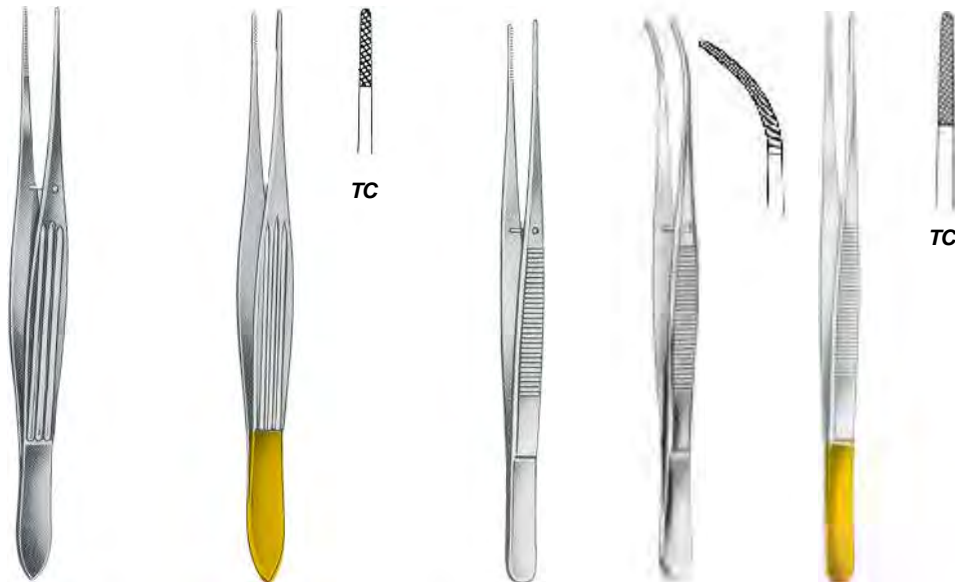

cm	in	McIndoe	McIndoe	Semken	Semken	Semken
12.0	4¾"			15-02848-12	15-02849-12	15-02852-12
15.0	6"	15-02842-15	15-02844-15	15-02848-15	15-02849-15	15-02852-15



Taylor

15-02856-17 15-02857-17 15-02862-17 15-02863-17 15-02867-17

17.5cm/7"



Smooth Jaw

cm	in	Waugh		Bonney	Brophy	Brophy
15.0	6"	15-02870-15				
18.0	7"	15-02870-18	15-02874-18	15-02882-18		
20.0	8"	15-02870-20	15-02874-20	15-02878-20	15-02886-18	15-02887-18

General Instruments Micro Forceps

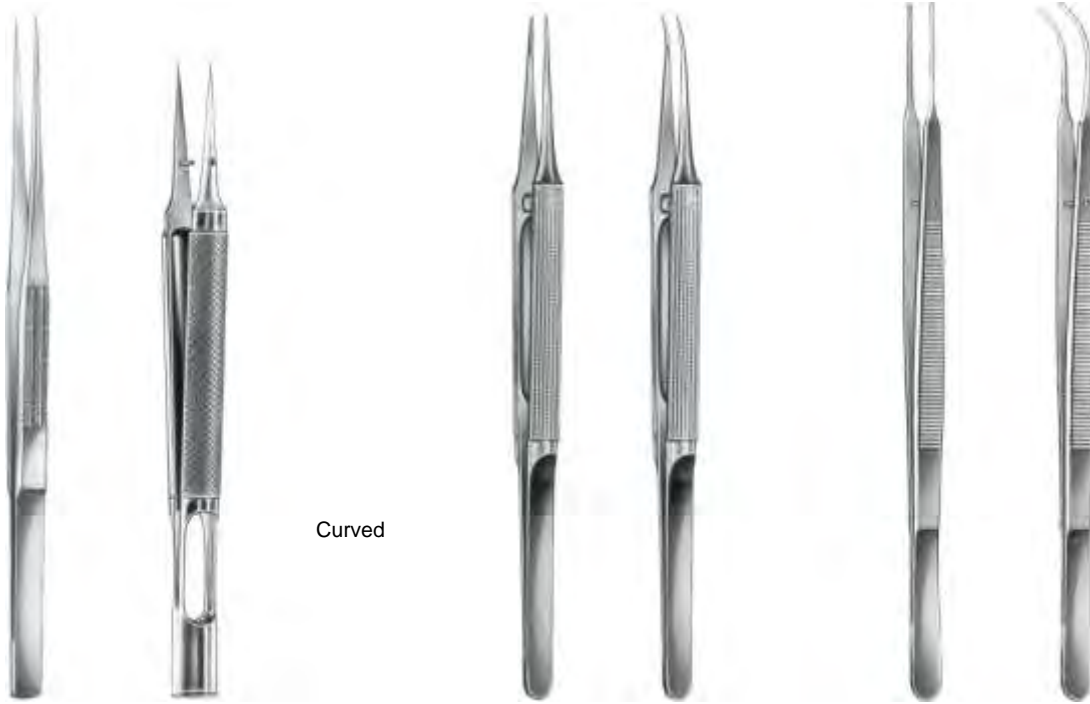

Curved

Gerald

cm	in						
12.0	4¾"			15-02898-12	15-02899-12		
13.0	5"	15-02894-13	15-02895-13				
15.0	6"	15-02890-15		15-02898-15	15-02899-15		
17.5	7"					15-02902-17	15-02903-17
18.0	7"	15-02890-18		15-02898-18	15-02899-18		

Micro Tubal Forceps



Austin
15-02906-14
14cm/5½"

Austin
15-02908-18
18cm/7"

Neubuser
15-02912-20
20cm/8"

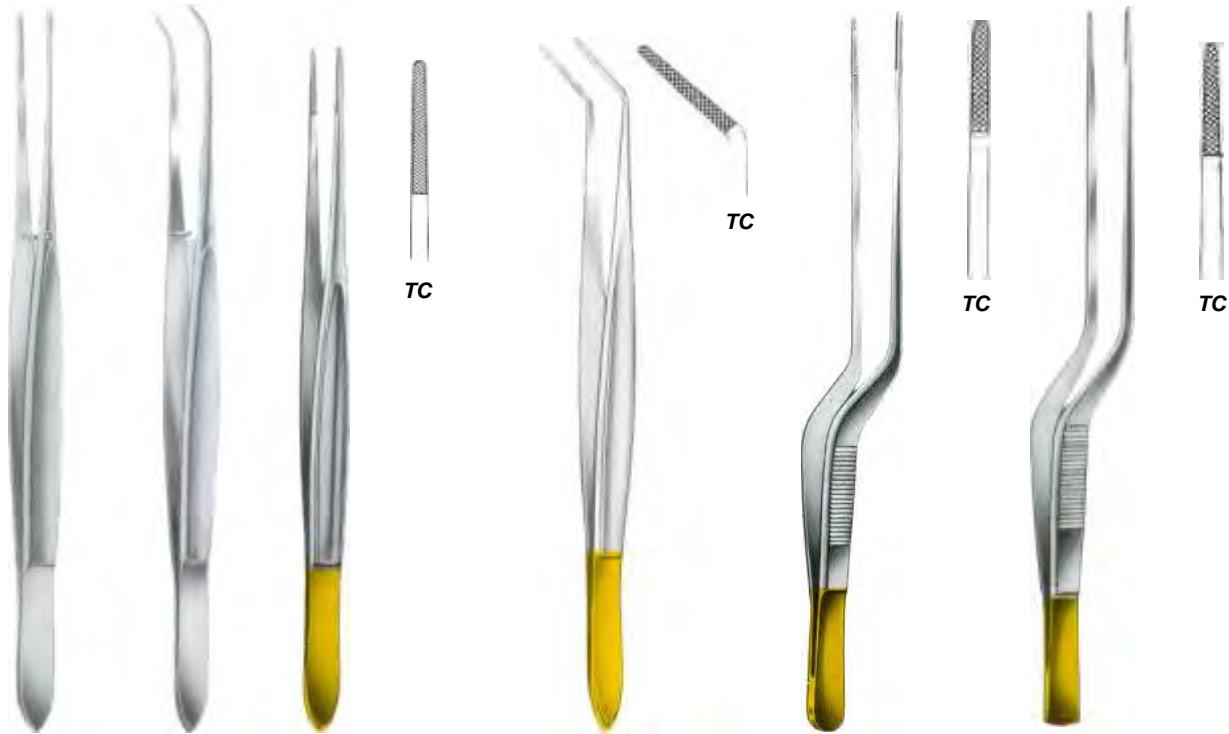

cm	in	Cushing	Cushing	Cushing	Cushing	Cushing-Taylor	Grunwald
18.0	7	15-02916-18	15-02917-18	15-02920-18	15-02923-18	15-02927-18	15-02929-18

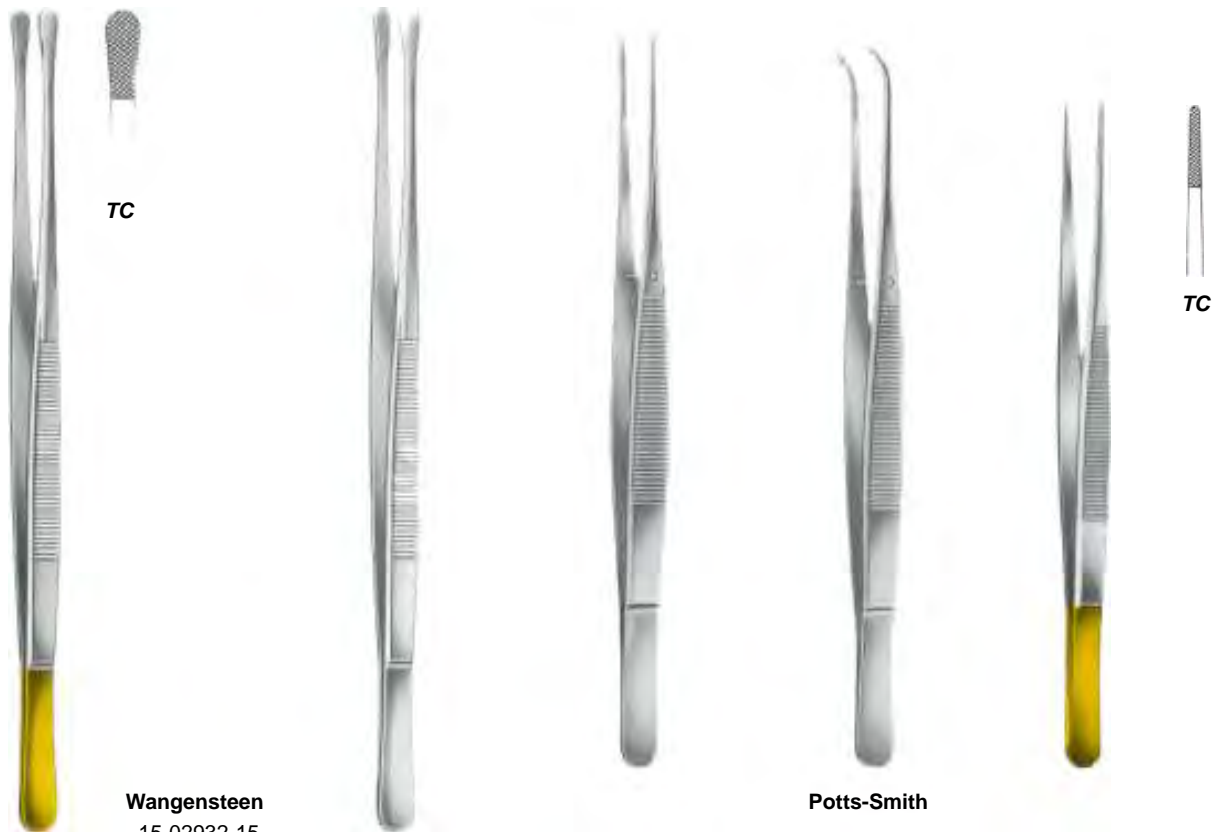

cm	in	Wangensteen		Potts-Smith	
15.0	6"	15-02932-15			
18.0	7"		15-02936-18	15-02940-18	15-02944-18
20.0	8"			15-02940-21	15-02948-18
21.0	8 1/4"			15-02940-25	15-02948-20
23.0	9"	15-02932-23	15-02936-23		15-02948-23
25.0	10"	15-02932-25		15-02944-25	15-02948-25

General Instruments Tissue Forceps



cm	in	Standard 1:2	Oehler 1:2	Standard 2:3	Standard 3:4	Standard 4:5	Standard 1:2
10.5	4¼"	15-02952-10					
11.5	4½"	15-02952-11					
13.0	5"	15-02952-13		15-02960-13	15-02964-13	15-02968-13	15-02972-13
14.5	5½"	15-02952-14	15-02956-14	15-02960-14	15-02964-14	15-02968-14	15-02972-14
15.0	6"	15-02952-15					
16.0	6¼"	15-02952-16	15-02956-16	15-02960-16	15-02964-16	15-02968-16	15-02972-16
18.0	7"	15-02952-18	15-02956-18	15-02960-18			15-02972-18
20.0	8"	15-02952-20	15-02956-20	15-02960-20			15-02972-20
25.0	10"	15-02952-25	15-02956-25	15-02960-25			15-02972-25
30.0	12"	15-02952-30	15-02956-30	15-02960-30			

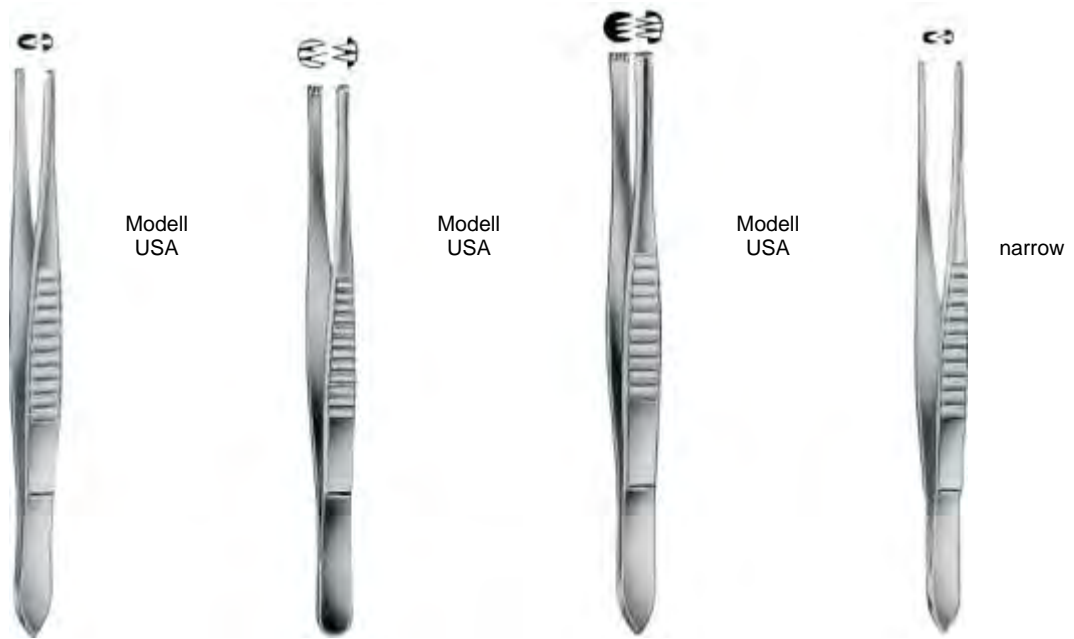

Standard

cm	in	1:2	2:3	3:4	1:2
12.0	4 ³ / ₄ "	15-02976-12	15-02980-12		
13.0	5"	15-02976-13	15-02980-13		15-02988-13
14.5	5 ³ / ₄ "	15-02976-14	15-02980-14	15-02984-14	15-02988-14
15.5	6"	15-02976-15			15-02988-15
18.5	7 ¹ / ₄ "	15-02976-18	15-02980-18		
21.0	8 ¹ / ₄ "	15-02976-21	15-02980-21		
25.0	10"	15-02976-25	15-02980-25		
31.0	12 ¹ / ₄ "	15-02976-31	15-02980-31		



cm	in	Lerche	Stone	Treves
13.0	5"			15-03000-13
15.0	6"	15-02992-15	15-02996-15	15-03000-15

General Instruments Tissue Forceps

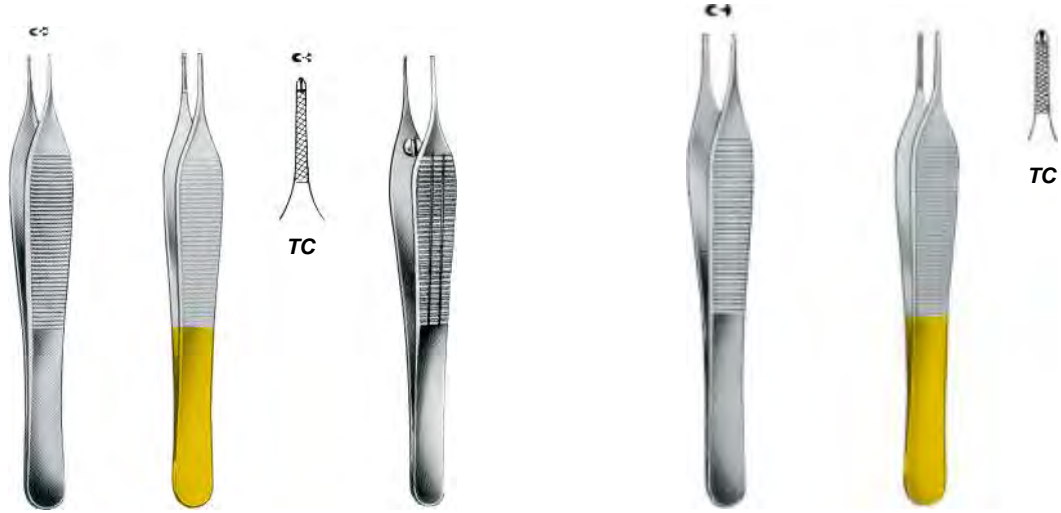

cm	in	Micro-Adson			Ewald	Standard-Adson
12.0	4 $\frac{3}{4}$ "	15-03004-12	15-03008-12	15-03012-12	15-03016-12	15-03020-12
15.5	6"	15-03004-15	15-03008-15	15-03012-15		15-03020-15



cm	in	Adson			Adson-Brown		
12.0	4 $\frac{3}{4}$ "	15-03024-12	15-03028-12	15-03032-12	15-03036-12	15-03040-12	15-03041-12
15.0	6"	15-03024-15	15-03028-15				



Gillies
15-03046-15 15 cm/6"
15-03046-20 20 cm/8"



Gillies
15-03050-15 15 cm/6"



TC



Brown
15-03054-15 15 cm/6"
15-03054-20 20 cm/8"
15-03054-25 25 cm/10"



Semken
15-03058-12 12 cm/4³/₄" 15-03062-12
15-03058-15 15 cm/6" 15-03062-15



Adlerkreutz
15-03066-15 15 cm/6"
15-03066-20 20 cm/8"
15-03066-25 25 cm/10"



Adlerkreutz
15-03070-15 15 cm/6"
15-03070-20 20 cm/8"
15-03070-25 25 cm/10"



Taylor
15-03074-17 17.5 cm/7"



Taylor
15-03075-17 17.5 cm/7"



Taylor
15-03078-17 17.5 cm/7"



Taylor
15-03079-17 17.5 cm/7"

General Instruments Tissue Forceps



cm	in	Waugh	Brophy	Brophy	Gerald	Gerald
15	6"	15-03082-15				
18	7"	15-03082-18			15-03092-18	15-03093-18
20	8"	15-03082-20	15-03086-20	15-03087-20		



15-04000-18	18 cm/7"	15-04001-18
15-04000-21	21 cm/8¼"	15-04001-21
15-04000-25	25 cm/10"	15-04001-25

Cushing
15-03096-18
17.5 cm/7"

Cushing
15-03097-18
17.5 cm/7"

Potts-Smith



Duval
15-04004-14 14.5 cm/5¾"



Collin-Duval
15-04008-20 20 cm/8"



Durante
15-04012-14 14.5 cm/5¾"
15-04012-16 16.0 cm/6¼"
15-04012-20 20.0 cm/8"



Russ. Modell
15-04016-15 15 cm/6"
15-04016-20 20 cm/8"
15-04016-25 25 cm/10"



Mayo
15-04020-23 23 cm/9"



Ferris-Smith
18 cm/7"

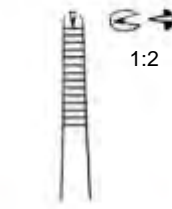

15-04022-18

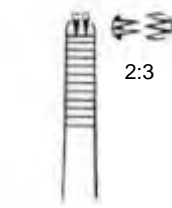

15-04023-18



Lane
15-04026-14 14.5 cm/5¾" 15-04028-14
15-04026-20 20.0 cm/8" 15-04028-20



General Instruments Tissue Grasping and Watchmakers Forceps

Grasping Forceps

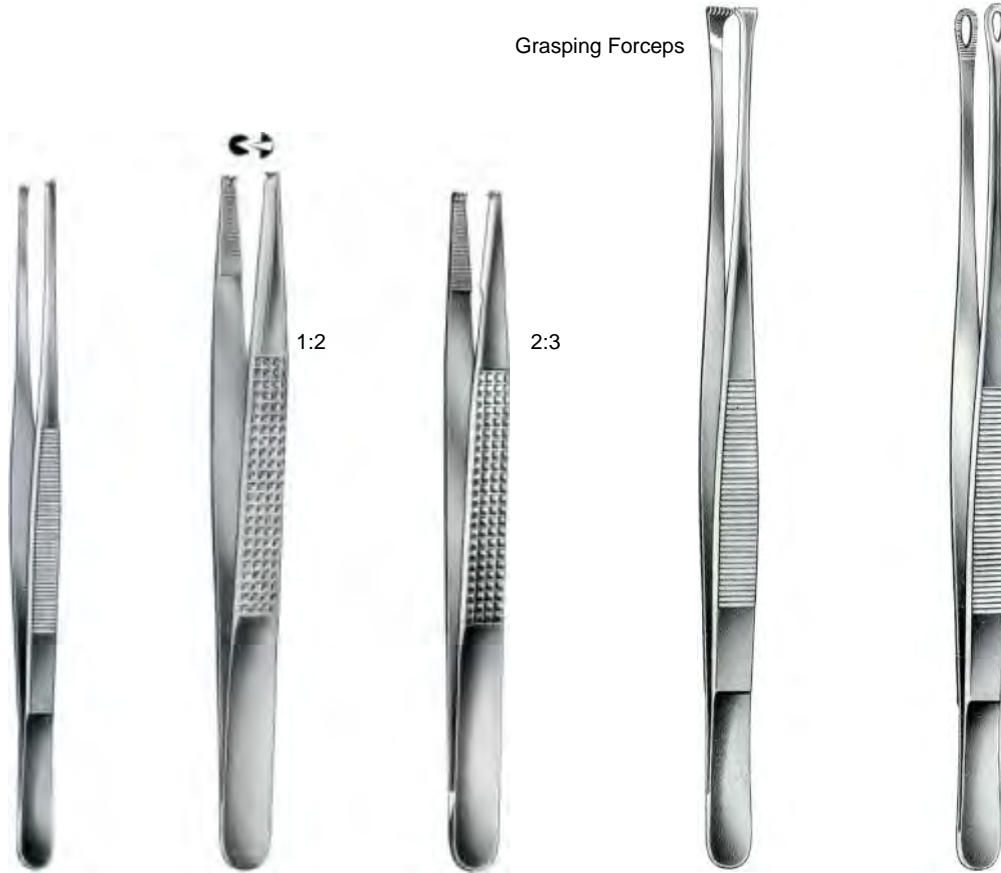

cm	in	Stille-Barraya	Bonney	Bonney	Nelson	Singley-Tuttle
15.0	6"				15-04042-15	
18.0	7"	15-04032-18	15-04036-18	15-04038-18	15-04042-18	15-04046-18
20.0	8"	15-04032-20			15-04042-23	
23.0	9"					15-04046-23
25.0	10"	15-04032-25				

Watchmaker's Forceps



No. 3
15-04050-03
11.5cm/4½"

No. 4
15-04050-04
11.5cm/4½"

No. 5
15-04050-05
11.5cm/4½"

No. 7
15-04050-07
11.5cm/4½"



cm	in						
10.5	4¼"	15-04054-10	15-04055-10	15-04057-10	15-04060-10	15-04061-10	15-04063-10

Splinter Forceps
With pin

Smooth

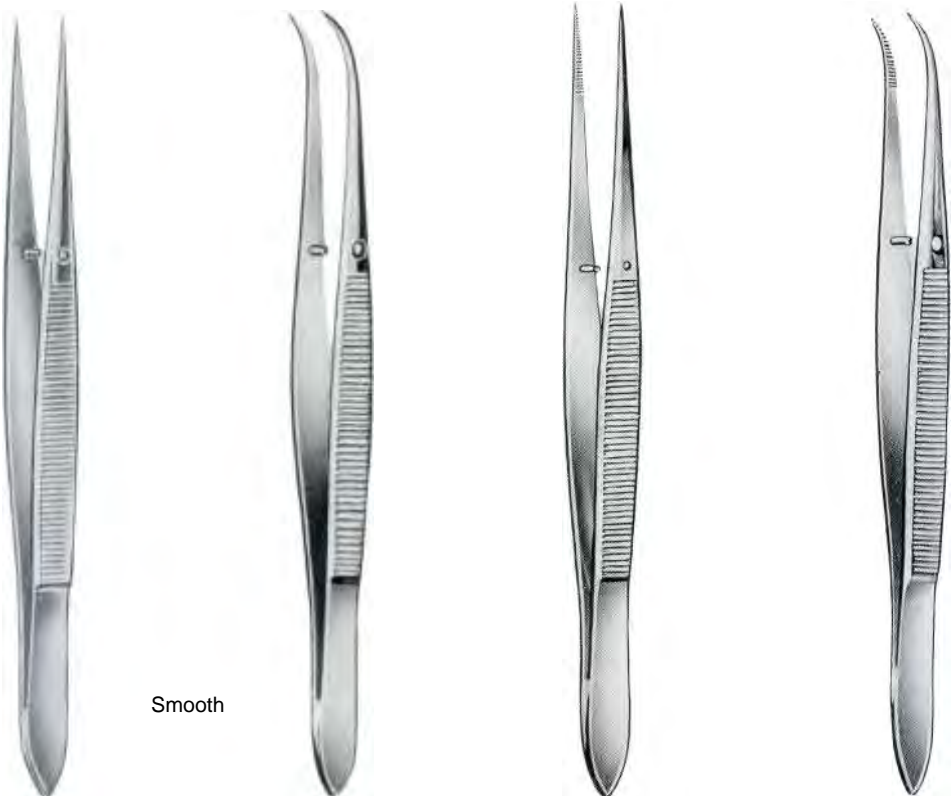

cm	in				
9.0	3½"	15-04066-09	15-04067-09	15-04070-09	15-04071-09
10.5	4¼"	15-04066-10	15-04067-10	15-04070-10	15-04071-10
11.5	4½"	15-04066-11	15-04067-11	15-04070-11	15-04071-11
12.5	5"	15-04066-12	15-04067-12	15-04070-12	15-04071-12



Feilchenfeld
15-04074-07 7.5cm/3"
15-04074-09 9.0cm/3½"
15-04074-11 11.5cm/4½"



15-04078-10



Hunter
10.5cm/4¼" 15-04079-10



15-04082-10



Walter-Carmalt
10.5cm/4¼" 15-04083-10



Peet
15-04087-11
11.5cm/4½"



Stieglitz
13.5cm/5¼"

Without Ratchet
15-04090-13



With Ratchet
15-04094-13



15-04091-13

15-04095-13



Ralk
15-04098-15
15cm/6"



Ralk
15-04099-15
15cm/6"

Ligature Forceps



Ochsner
15-04102-14
14.5cm/5¾"



Adson
15-04106-12
12cm/4¾"



Adson
15-04108-12
12cm/4¾"

Cilia Forceps



Beaupre
15-04111-12
12cm/4¾"



Henry
15-04115-12
12cm/4¾"



Gradle
15-04118-09
9.5cm/3¾"



Barraquer
15-04121-10
10.5cm/4¼"



Bennett
15-04124-07
7cm/2¾"

General Instruments Cilia and Cover Glass Forceps



cm	in	Beer	Douglas	Ziegler	
8.0	3¼"	15-04128-08			
9.0	3½"	15-04128-09	15-04132-09	15-04136-09	15-04140-09



Kuehne
15-04144-10
10.5cm/4¼"

Kuehne
15-04145-10
10.5cm/4¼"

15-04148-10
10.5cm/4¼"



Atrauma

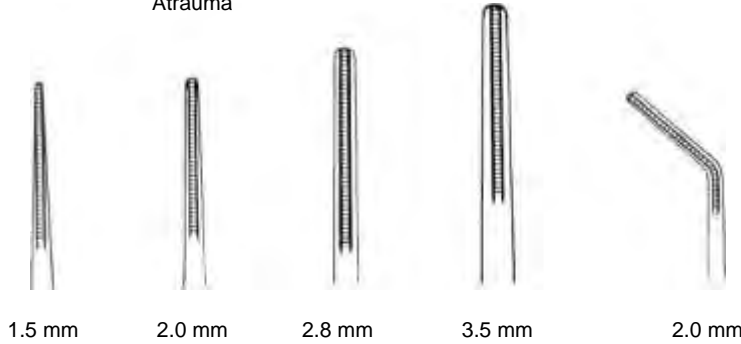

cm	in	1.5 mm	2.0 mm	2.8 mm	3.5 mm	2.0 mm
16.0	6¼"	15-04154-16	15-04156-16	15-04158-16	15-04160-16	15-04161-16
20.0	8"	15-04154-20	15-04156-20	15-04158-20	15-04160-20	15-04161-20
24.0	9½"	15-04154-24	15-04156-24	15-04158-24	15-04160-24	15-04161-24
30.0	12"	15-04154-30	15-04156-30	15-04158-30	15-04160-30	15-04161-30

Adson

15-04164-12	12cm/4¾"
15-04164-15	15cm/6"



cm	in	Troeltsch (Wilde)	Troeltsch	Lucae	Lucae	Jansen (Gruenwald)	Jansen
11.5	4½"	15-04167-11					
12.0	4¾"	15-04167-12	15-04171-12	15-04175-14	15-04177-14		
14.0	5½"						
15.0	6"	15-04167-15					
16.0	6¼"					15-04181-16	15-04183-16
18.0	7"	15-04167-18				15-04181-18	15-04183-18
20.0	8"					15-04181-20	15-04183-20



Jaw spoon, Shaped
3 mm 15-04187-03
5 mm 15-04187-05



Jaw falt, Serrated
3 mm 15-04189-03
5 mm 15-04189-05



Curette Jaw, Toothed
3 mm 15-04191-03
5 mm 15-04191-05

Yasargil
22cm/8½"



1 x 0.5 mm Ø



1 x 0.5 mm Ø



2 x 1 mm Ø



2 x 1 mm Ø

15cm/6"	15-04194-16	15-04196-16		
18cm/7"			15-04198-18	15-04200-18
22cm/8¾"	15-04194-22	15-04196-22	15-04198-22	15-04200-22



Yasargil

22cm/8¾"
24cm/9½"

Ø 3 mm
15-04203-22
15-04203-24

Ø 5 mm
15-04205-22
15-04205-24

Ø 7 mm
15-04207-24

22cm/8¾"

Ø 3 mm
15-04209-22

Ø 3 mm
15-04211-22

Ø 5 mm
15-04213-22

Ø 5 mm
15-04215-22
22cm/8¾"



Yasargil

16cm/6 1/4"
18cm/7"
20cm/8"
22cm/8 3/4"
24cm/9 1/2"



0.6 mm
15-04219-16
15-04219-18
15-04219-20
15-04219-22
15-04219-24



0.9 mm
15-04221-16
15-04221-18
15-04221-20
15-04221-22
15-04221-24



15-04223-18
18cm/7"



Dieffenbach
16-04226-03
3.5cm/1 1/2"
16-04226-05
5cm/2"



Dieffenbach
16-04227-03
3.5cm/1 1/2"
16-04227-05
5cm/2"



Dieffenbach
16-04230-06
6cm/2 1/2"



Dieffenbach
16-04231-06
6cm/2 1/2"



Johns-Hopkins

Straight

For Bulldog Clamps

- 16-04234-01 38mm/1 1/2"
- 16-04234-02 51mm/2"
- 16-04234-03 57mm/2 1/4"
- 16-04234-04 63mm/2 1/2"
- 16-04234-05 70mm/2 3/4"
- 16-04234-06 75mm/3"
- 16-04234-07 90mm/3 1/2"

Curved

- 16-04235-01 38mm/1 1/2"
- 16-04235-02 51mm/2"
- 16-04235-03 57mm/2 1/4"
- 16-04235-04 63mm/2 1/2"
- 16-04235-05 70mm/2 3/4"
- 16-04235-06 75mm/3"
- 16-04235-07 90mm/3 1/2"



Johns-Hopkins
16-04237-24
24.5cm/9 3/4"

Haemorrhoidal Clamps



Carrel
16-04240-10
10cm/4"



Chaput
16-04242-13
13cm/5"

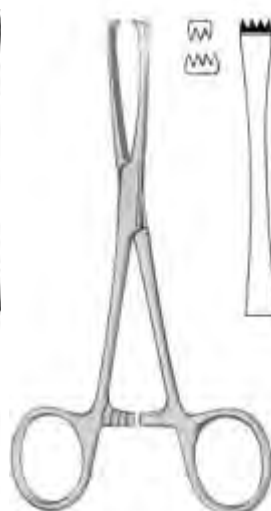

Tuffier
16-04246-13
13cm/5"



Pratt
16-04250-15
15cm/6"



Terrier
16-04254-10 10 cm/4"



Pennington
16-04258-15 15 cm/6"
16-04558-20 20 cm/8"



Pea Pean
16-04262-12 12.5 cm/5"

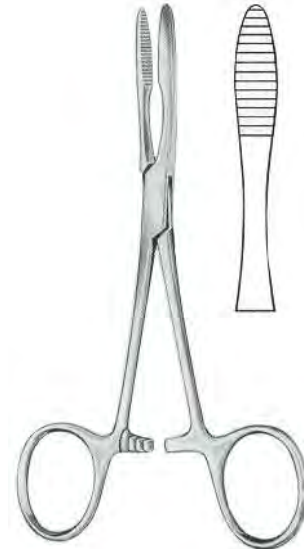

Pean
16-04266-14 14 cm/5 3/4"
16-04566-16 16 cm/6 1/4"

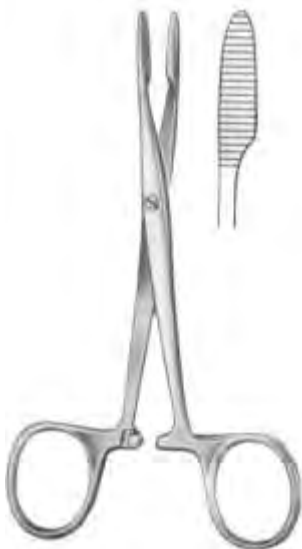

Pean
16-04270-14 14 cm/5 1/2"



Collin
16-04274-15 15.5 cm/6"



Collin
16-04278-14 14 cm/5 1/2"



Collin
16-04282-16 16.5 cm/6 1/2"



Hartmann
10 cm/4"



16-04286-10



16-04290-10



16-04287-10



16-04291-10



Halstead-Mosquito
12 cm/4¾"
14 cm/5½"



16-04294-12
16-04294-14



16-04295-12
16-04295-14



16-04298-12
16-04298-14



16-04299-12
16-04299-14



Micro-Mosquito
10 cm/4"
12 cm/4¾"



16-04302-10
16-04302-12



16-04303-10
16-04303-12



16-04306-10
16-04306-12



16-04307-10
16-04307-12



Jacobson-Halstead
13 cm/5"



16-04310-13



16-04311-13

Very fine

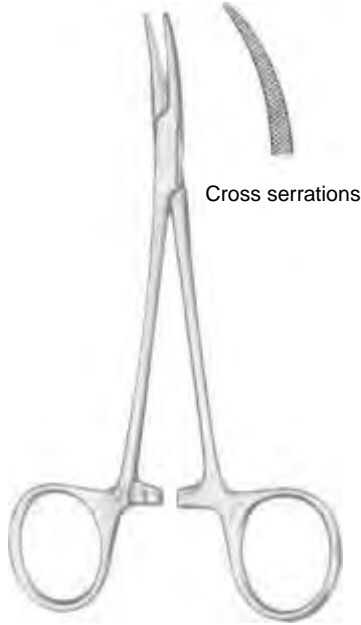

Cross serrations

16-04315-12
12 cm/4¾"



Halstead-Mosquito
18 cm/7"
21 cm/8¼"

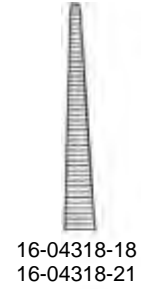

16-04318-18
16-04318-21



16-04319-18
16-04319-21

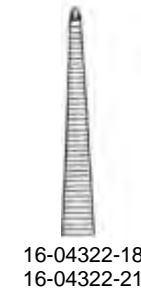

16-04322-18
16-04322-21



16-04323-18
16-04323-21



Kelly
14 cm/5½"

Kelly-Rankin
16 cm/6¼"

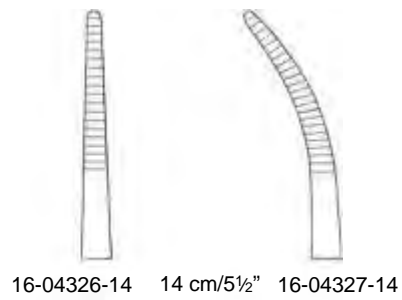

16-04326-14 14 cm/5½" 16-04327-14

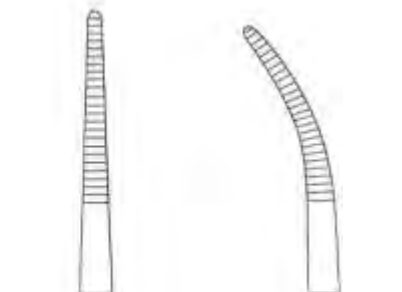

16-04330-16 16 cm/6¼" 16-04331-16



Crile
14 cm/5½"

Crile-Rankin
16 cm/6¼"

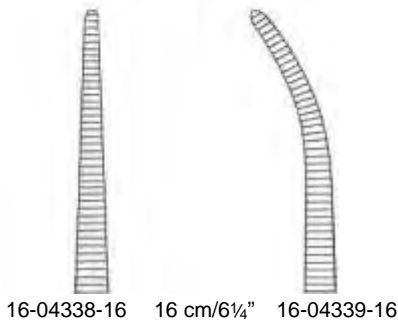
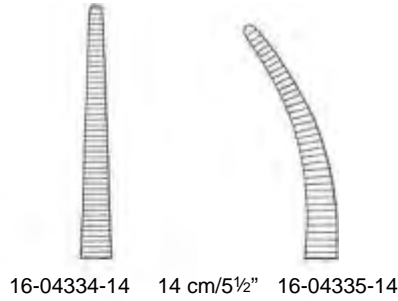

Baby-Crile
14 cm/5½"

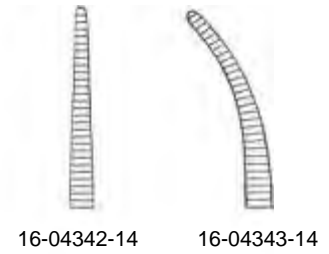

Crile
14 cm/5½"

Crile-Rankin
16 cm/6¼"

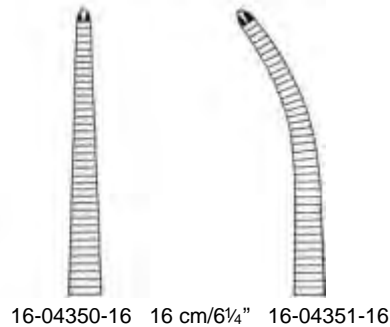
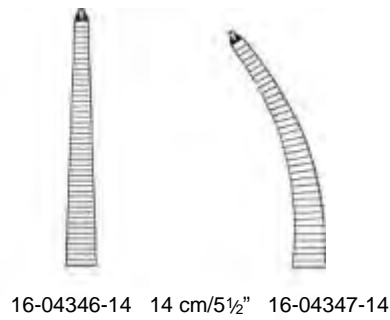

Baby-Crile
14 cm/5½"

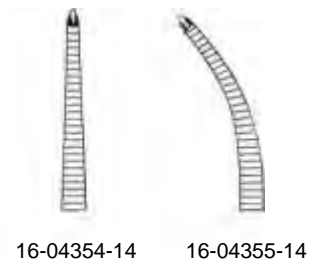



Coller-Crile



16-04358-14 14 cm/5½"



16-04362-16 16 cm/6¼"



Coller-Crile
16-04367-16
16 cm/6¼"



Leriche
15 cm/6"



16-04370-15



16-04371-15



16-04374-15



16-04375-15



Providence
14 cm/5½"



16-04378-14



16-04379-14

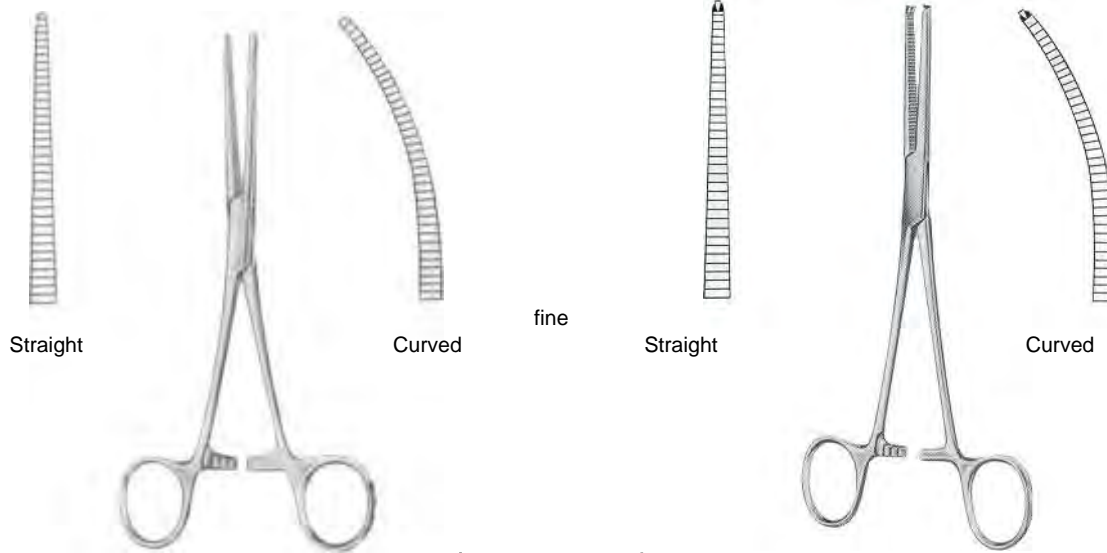

Rochester-Pean		cm	in	Ochsner-Kocher	
16-04382-13	16-04383-13	13.0	5"	16-04386-13	16-04387-13
16-04382-14	16-04383-14	14.0	5½"	16-04386-14	16-04387-14
16-04382-16	16-04383-16	16.0	6¼"	16-04386-16	16-04387-16

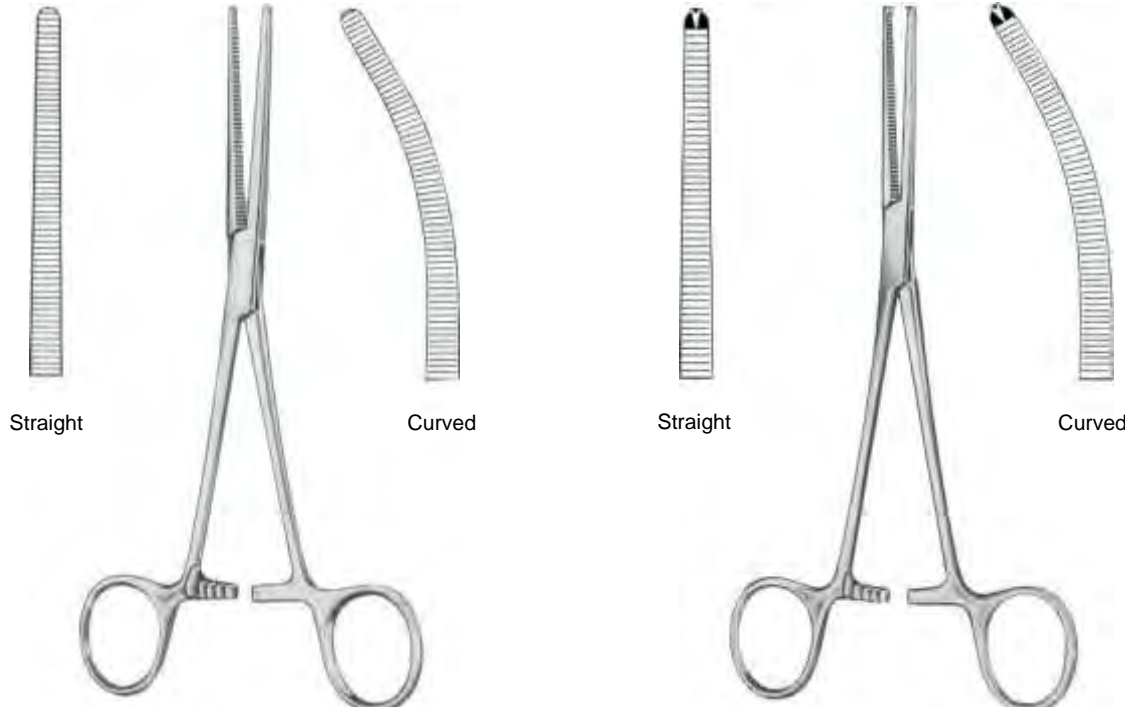

Rochester-Pean		cm	in	Ochsner-Kocher	
16-04390-13	16-04391-13	13.0	5"	16-04394-13	16-04395-13
16-04390-14	16-04391-14	14.0	5½"	16-04394-14	16-04395-14
16-04390-16	16-04391-16	16.0	6¼"	16-04394-16	16-04395-16
16-04390-18	16-04391-18	18.0	7"	16-04394-18	16-04395-18
16-04390-20	16-04391-20	20.0	8"	16-04394-20	16-04395-20
16-04390-22	16-04391-22	22.0	8¾"	16-04394-22	16-04395-22
16-04390-24	16-04391-24	24.0	9½"	16-04394-24	16-04395-24
16-04390-26	16-04391-26	26.0	10¼"	16-04394-26	16-04395-26
16-04390-30	16-04391-30	30.0	12"	16-04394-30	16-04395-30

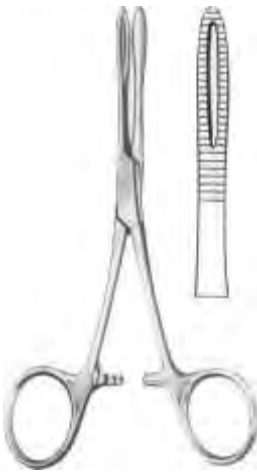
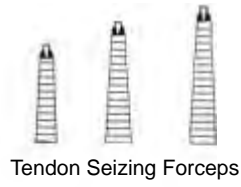

Kronlein
16-04398-13
13cm/5"



Brand
16-04402-15 15cm/6"
16-04402-19 19cm/7½"
16-04402-24 24cm/9½"



Brand
16-04403-15 15cm/6"
16-04403-19 19cm/7½"
16-04403-24 24cm/9½"

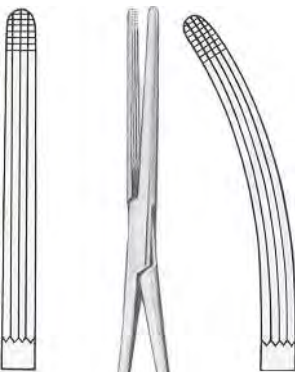

16-04406-16
16-04406-20

16-04407-16
16-04407-20

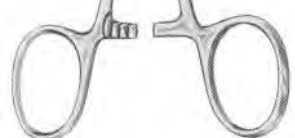

Rochester-Carmalt
16cm/6¼"
20cm/8"

Lateral Curved



16-04410-12

Mosquito-Dandy
12cm/4¾"



16-04412-12

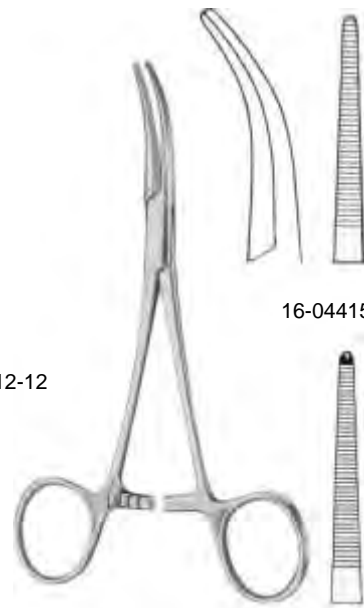

16-04415-14

Dandy
14cm/5½"

16-04416-14



Lovelace
16-04420-15
15.5cm/6"



Dixon-Lovelace
16-04424-16
16cm/6¼"



Dixon-Lovelace
16-04426-16
16cm/6¼"

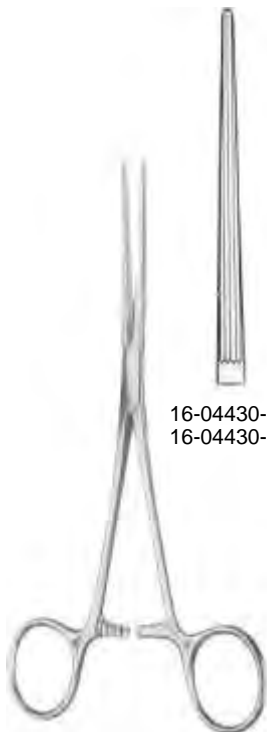

Bainbridge
15cm/6"
18cm/7"



16-04430-15
16-04430-18



16-04431-15
16-04431-18



Fuchsig
16-04435-19
19cm/7½"

General Instruments Hemostatic Dissecting and Ligature Forceps



Adson
18.5cm/7¼"



16-04438-18



16-04439-18

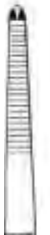

16-04442-18



16-04443-18



Nissen
16-04446-18 18.5cm/7¼"
16-04446-22 22.0cm/8¾"



Baby-Adson



16-04449-14
14cm/5½"



16-04451-18
18cm/7"

Very Fine

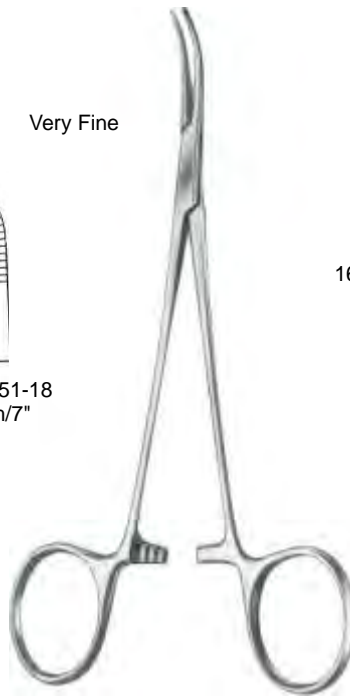

Jacobson-Adson
18cm/7"



16-04454-18



16-04455-18



16-04457-18

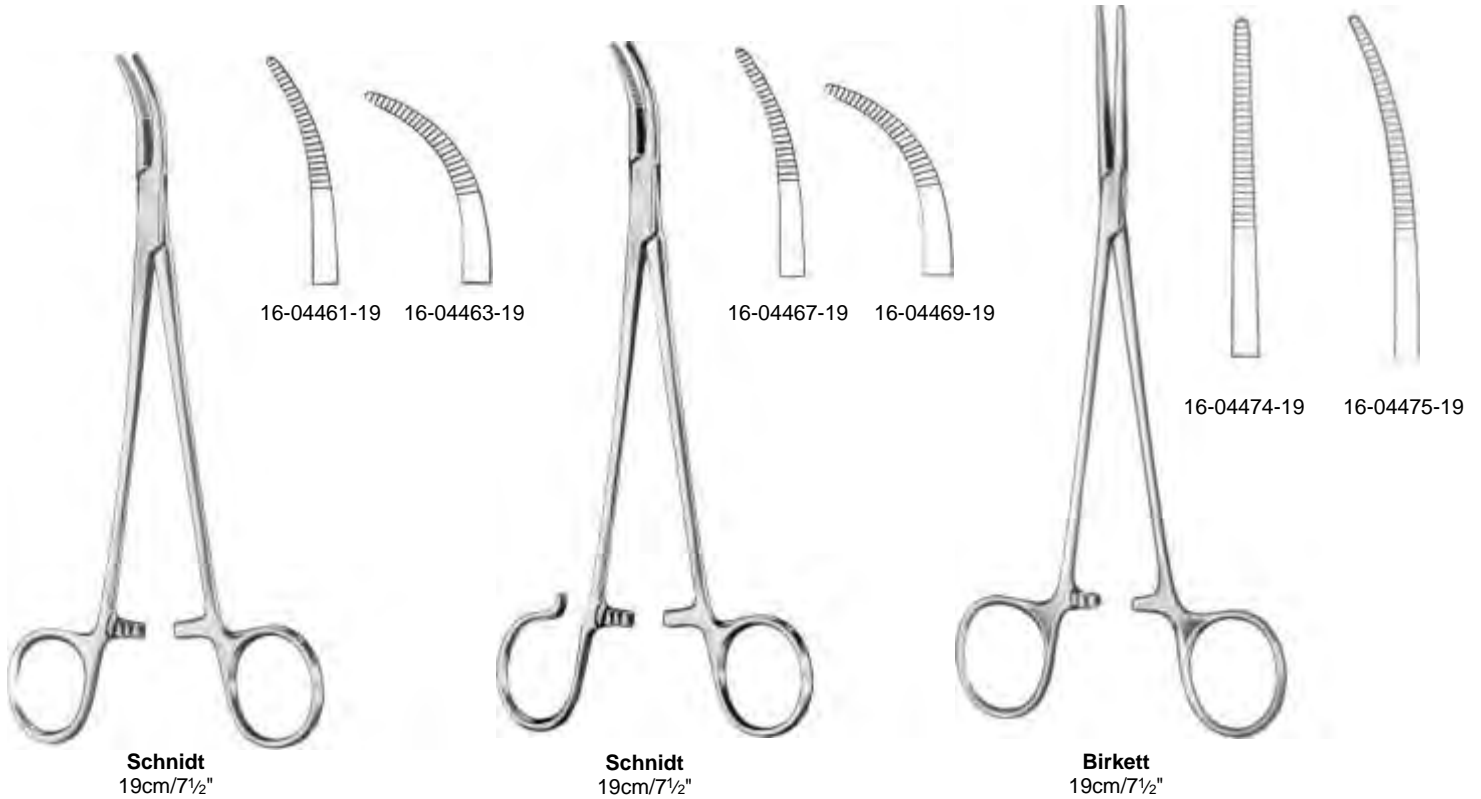

20cm/8"	16-04478-20	16-04479-20	16-04482-20	16-04483-20
22cm/8¾"	16-04478-22	16-04479-22	16-04482-22	16-04483-22
24cm/9½"	16-04478-24	16-04479-24	16-04482-24	16-04483-24
26cm/10¼"	16-04478-26	16-04479-26	16-04482-26	16-04483-26

Bengolea



Bridge
27cm/10½"



16-04486-27



16-04487-27



Roberts
22cm/8¾"



16-04490-22



16-04491-22



Kelly

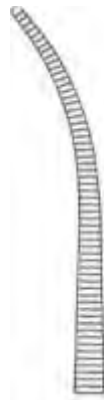

19cm/7½"
22cm/8¾"
24cm/9½"

16-04495-19
16-04495-22
16-04495-24



16-04497-19
16-04497-22
16-04497-24



16-04499-19
16-04499-22
16-04499-24



Crafoord-Sellors

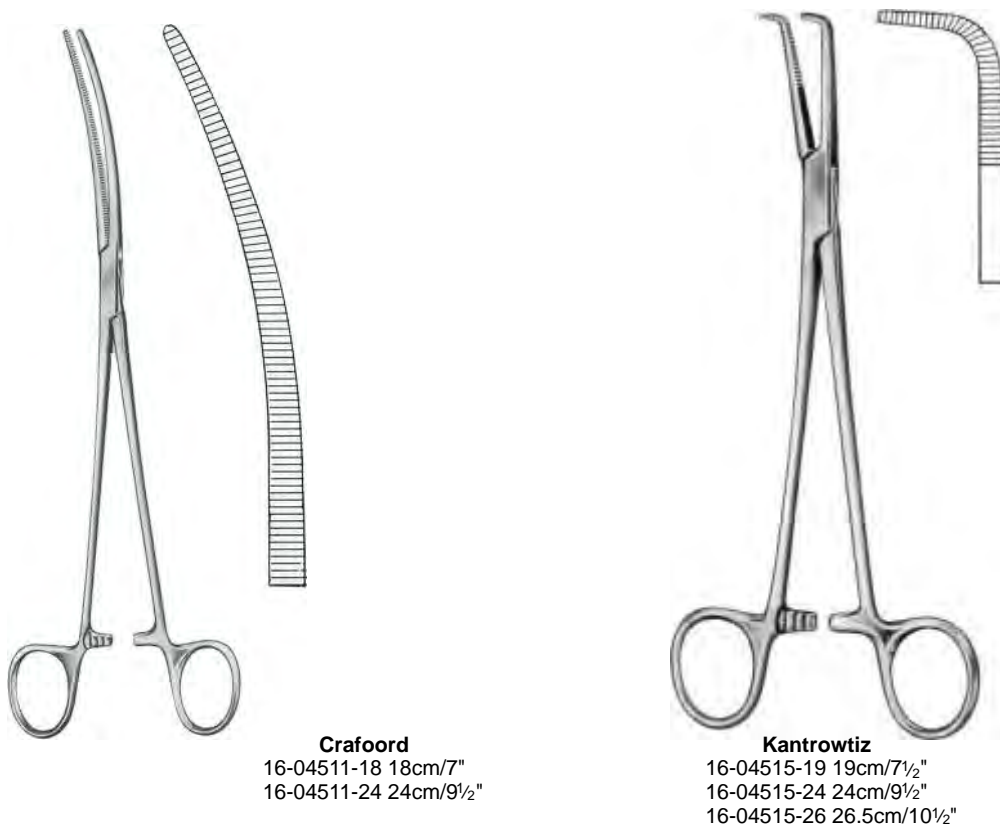



Rumel
23cm/9"



16-04519-23



16-04521-23



16-04523-23



16-04525-23

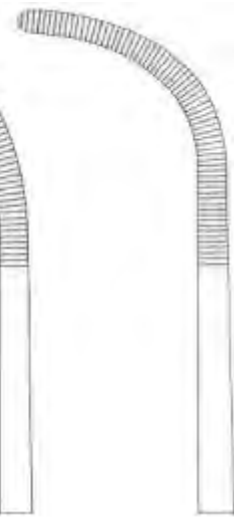

16-04527-23



Johns Hopkins
16-04531-20
20cm/8"



Zenker
29.5cm/11½"



16-4534-29



16-4535-29

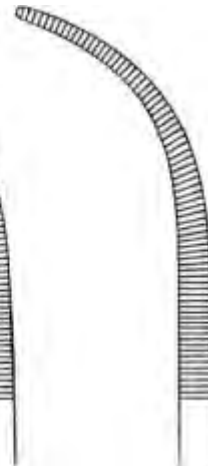

16-4537-29

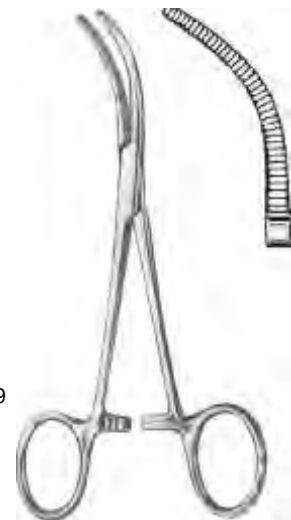

Baby-Overholt
16-04541-13
13.5cm/5¼"



Overholt-Slim



16-04545-18
18.5cm/7¼"

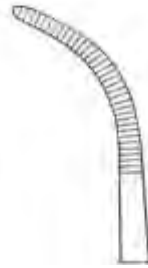

16-04547-20
20.5cm/8"



16-04549-21
21cm/8¼"

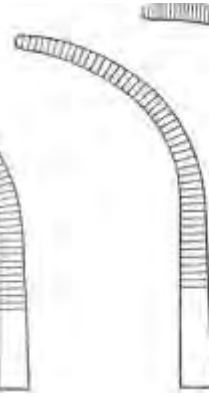

16-04551-21
21.5cm/8½"

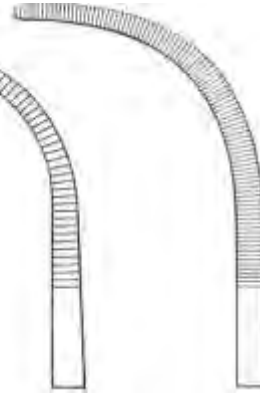

16-04553-24
24cm/9½"



Overholt-Slim



16-04557-18
18.5cm/7¼"



16-04559-20
20.5cm/8"



16-04561-21
21cm/8¼"

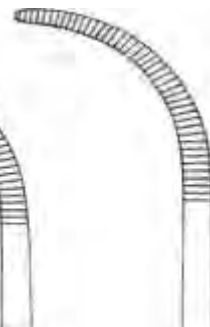

16-04563-21
21.5cm/8½"





Overholt-Geissendorfer
21cm/8¼"
27cm/10½"

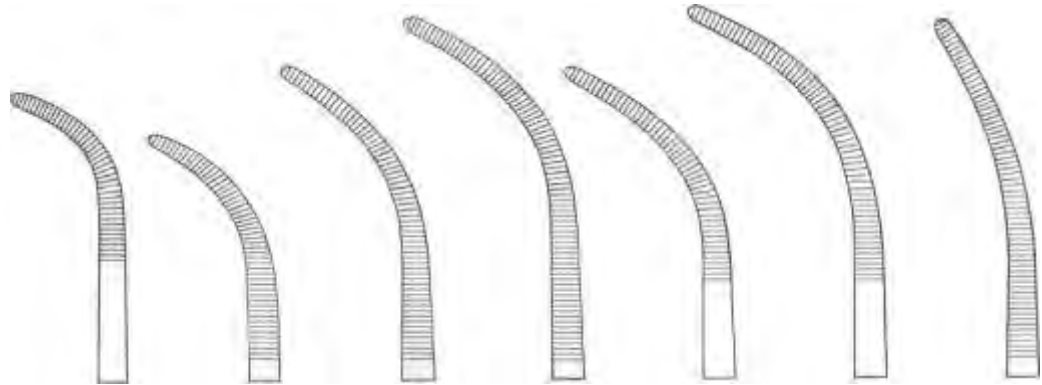

16-04567-21	16-04569-21	16-04571-21	16-04573-21	16-04575-21	16-04577-21	16-04579-21
16-04567-27	16-04569-27	16-04571-27	16-04573-27	16-04575-27	16-04577-27	16-04579-27



Overholt-Mixer
16-04581-21
21cm/8¼"

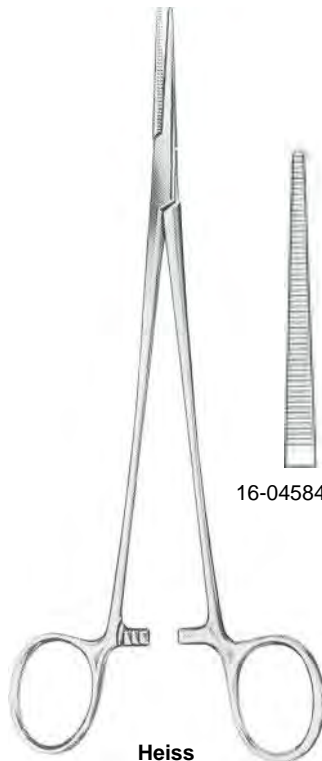

Heiss
20cm/8"

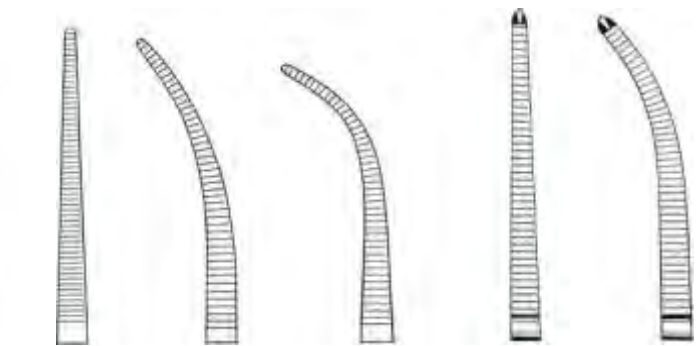

16-04584-20	16-04585-20	16-04587-20	16-04589-20	16-04591-20
-------------	-------------	-------------	-------------	-------------



Meeker
16-04595-27
27 cm/10½"

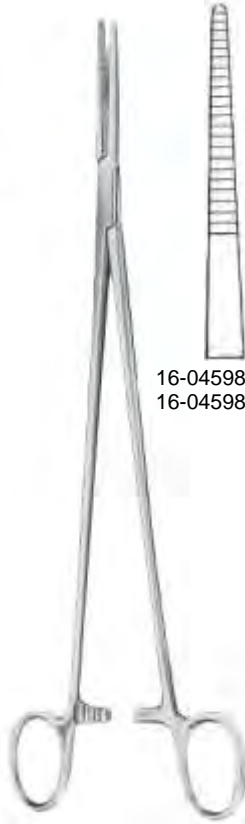

Toennis
21 cm/8¼"
26 cm/10¼"



16-04598-21
16-04598-27



16-04599-21
16-04599-27



16-04602-21
16-04602-27



16-04603-21
16-04603-27



Lower
16-04607-18
18 cm/7"



Gemini



16-04611-13
13 cm/5"

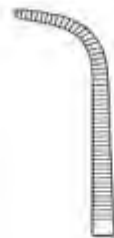

16-04611-18
18 cm/7"



16-04611-20
20 cm/8"



16-04611-23
23 cm/9"

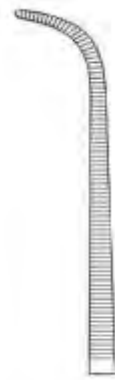

16-04611-25
25 cm/10"

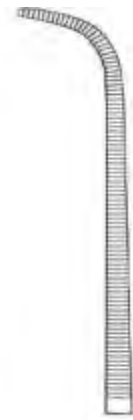

16-04611-27
27 cm/10½"



Mini-Gemini

16-04615-18
18 cm/7"

16-04615-22
22 cm/8¾"

16-04615-25
25 cm/10"

16-04615-28
28 cm/11"

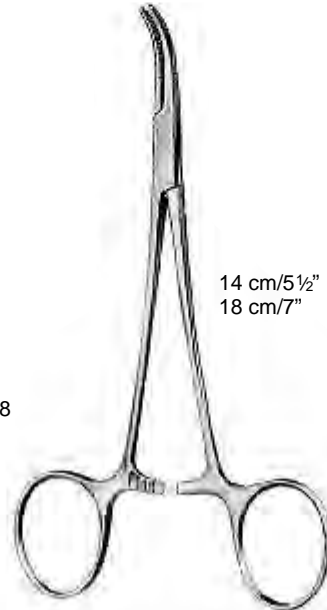

Baby-Mixer

14 cm/5½"
18 cm/7"

16-04619-14
16-04619-18

16-04621-14
16-04621-18



Mixer

16-04625-15 15 cm/6"
16-04625-19 19 cm/7½"



Mixer-O'Shaughnessy

16-04629-15 15.5 cm/6"
16-04629-19 19.0 cm/7½"

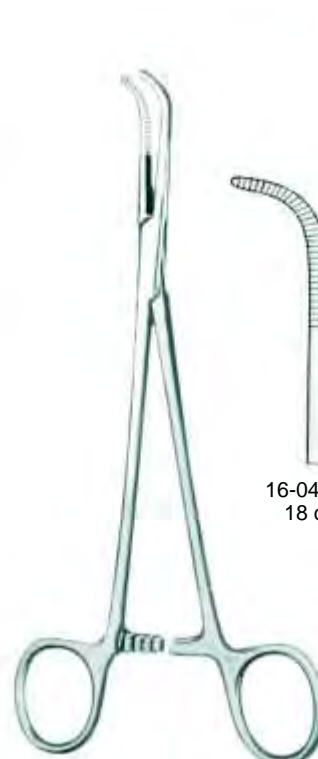

Mixer-Slim

16-04633-18
18 cm/7"

16-04633-23
23 cm/9"



16-04637-22
22 cm/8¾"

Mixer



16-04637-25
25 cm/10"

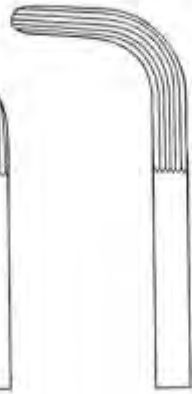

16-04637-25
25 cm/10"

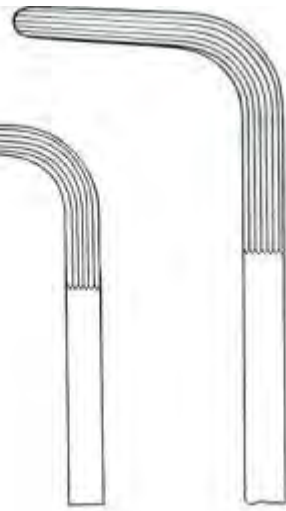

16-04637-28
28 cm/11"



Mixer
16-04641-22
22 cm/8¾"



Wickstroem
16-04645-20
20 cm/8"

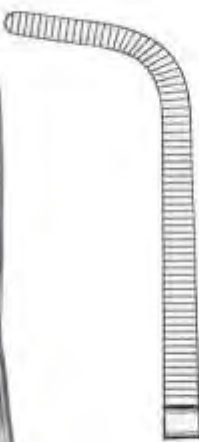

Finocchetto
16-04649-24
24 cm/9½"



Mc Quigg-Mixer
16-04653-22
22 cm/8¾"





Lawrence
16-04657-27
27.5 cm/10¾"

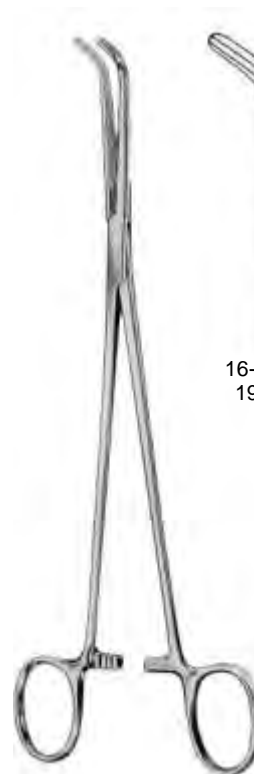

Lahey (Sweet)

16-04661-19
19 cm/7½"

16-04663-23
23 cm/9"

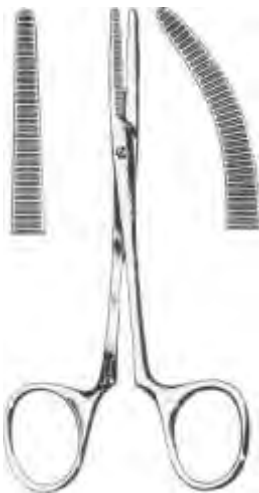

Spencer-Wells

- | | | |
|-------------|----------|-------------|
| 16-04664-13 | 13 cm/5" | 16-04665-13 |
| 16-04664-15 | 15 cm/6" | 16-04665-15 |
| 16-04664-18 | 18 cm/7" | 16-04665-18 |
| 16-04664-20 | 20 cm/8" | 16-04665-20 |
| 16-04664-23 | 23 cm/9" | 16-04665-23 |



Spencer-Wells

- | | | |
|-------------|-----------|-------------|
| 16-04668-13 | 13 cm/5" | 16-04669-13 |
| 16-04668-14 | 14 cm/5½" | 16-04669-14 |
| 16-04668-15 | 15 cm/6" | 16-04669-15 |
| 16-04668-18 | 18 cm/7" | 16-04669-18 |
| 16-04668-20 | 20 cm/8" | 16-04669-20 |
| 16-04668-23 | 23 cm/9" | 16-04669-23 |

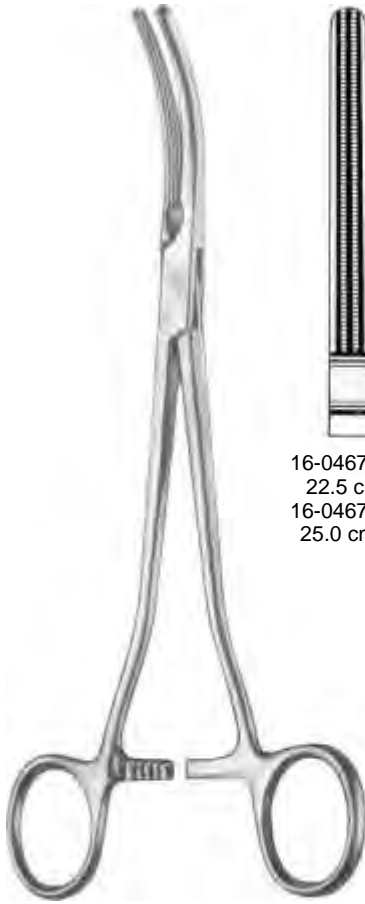

Rogers

16-04672-22
22.5 cm/9"
16-04672-25
25.0 cm/10"



16-04673-22
22.0 cm/8³/₄"
16-04673-24
24.5 cm/9³/₄"

16-04675-21
21.5 cm/8¹/₂"
16-04675-24
24.0 cm/9¹/₂"



16-04679-20
20.5 cm/8"
16-04679-23
23.5 cm/9"



Heaney

19.5 cm/7¹/₂"
21.5 cm/8¹/₄"
23.5 cm/9"



16-04683-19
16-04683-21
16-04683-23

16-04685-19
16-04685-21
16-04685-23



Heaney-Slim
16-04687-21
21 cm/8¹/₄"



Ballentine
16-04690-21
21cm/8¼"



Heaney-Ballentine
16-04691-21
21cm/8¼"



Tonsil Forceps

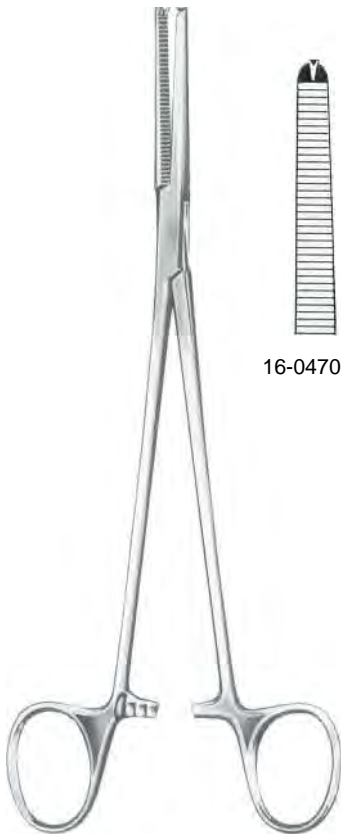

Fig. 1



Fig. 2

Negus
16-04695-19 19cm/7½" 16-04697-19



Phaneuf
21.5cm/8½"



16-04700-21

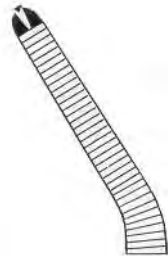

16-04701-21

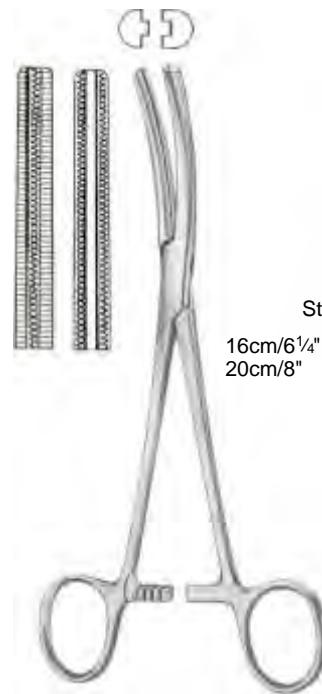

Haemorrhoidal Clamps

Straight

16cm/6¼" 16-04704-16
20cm/8" 16-04704-20

Curved

16-04705-16
16-04705-20

Fergusson

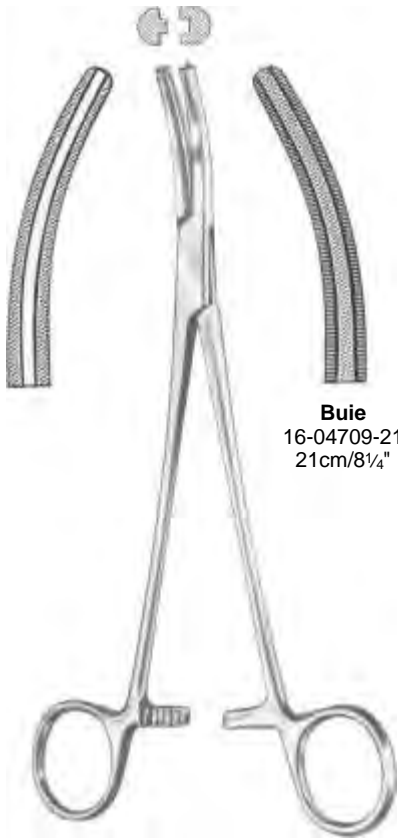

Buie
16-04709-21
21cm/8¼"

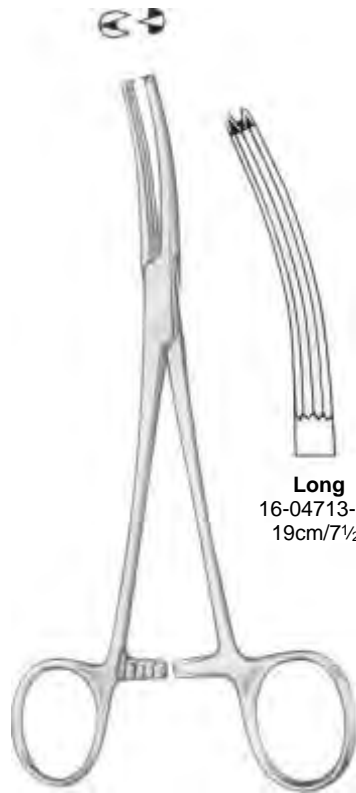

Long
16-04713-19
19cm/7½"

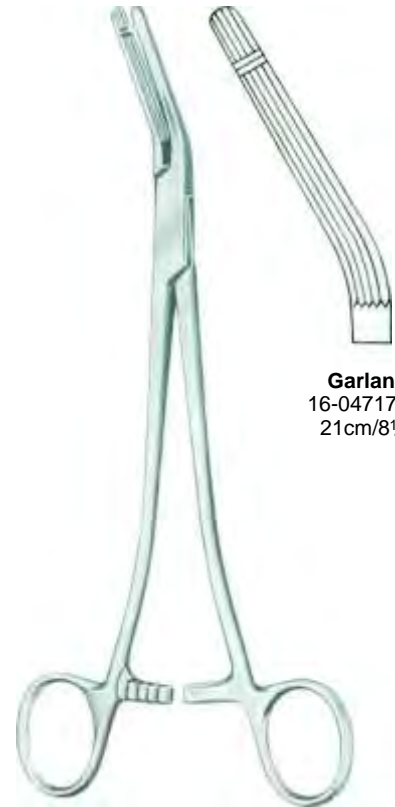

Garland
16-04717-21
21cm/8¼"

Gall Duct Clamps

Hysterectomy Forceps

Pressure Clamps

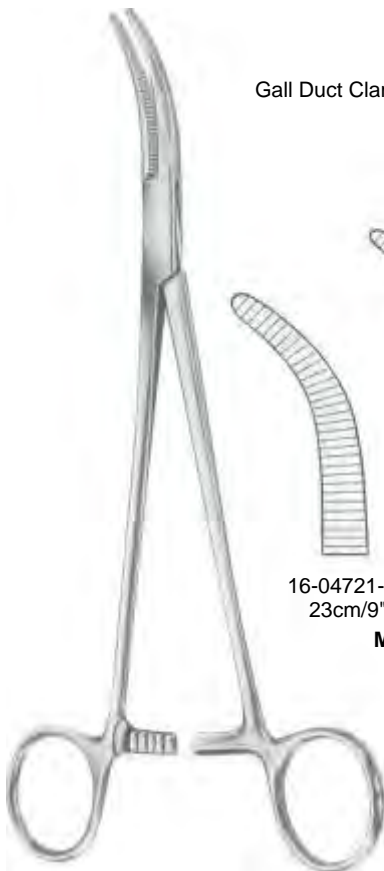

16-04721-23 23cm/9"
16-04723-24 24cm/9½"
Moynihan



16-04726-23 16-04727-23
Hozlbach
23.5cm/9¼"



Zweifel
16-04730-17
17.5cm/7"

Scalp Flap Forceps



Martel
16-04733-14
14cm/5½"

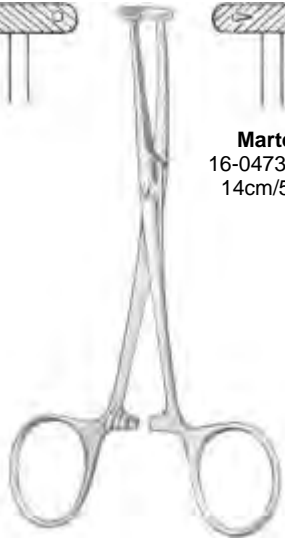

Werheim
16-04736-25
25cm/10"

Extra Strong



Werheim-Cullen
16-04739-21
21.5cm/8½"



Werheim
16-04743-24
24cm/9½"

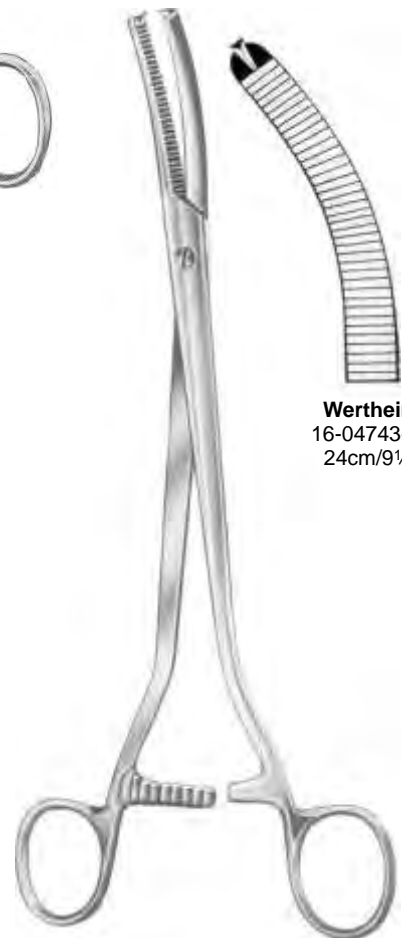

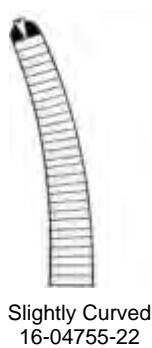
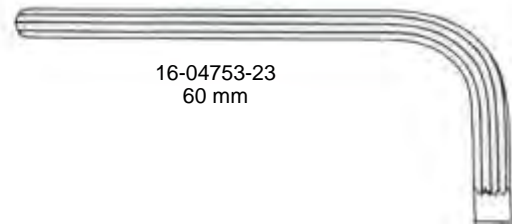
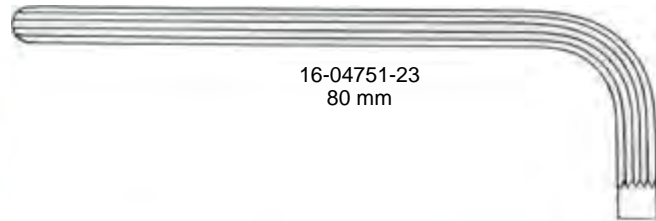



Wertheim
16-04765-18
18 cm/7"



Baby-Mikulicz
16-04769-14
14 cm/5½"

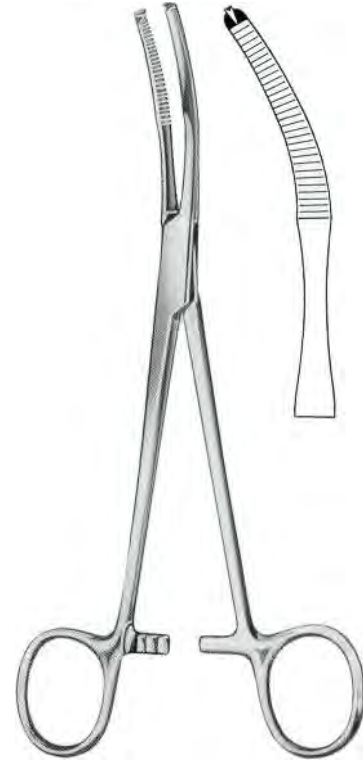

Mikulicz
16-04773-18 18cm/7"
16-04773-20 20cm/8"



Mikulicz
16-04777-20
20 cm/8"



Mikulicz
16-04781-18
18.5 cm/7¼"

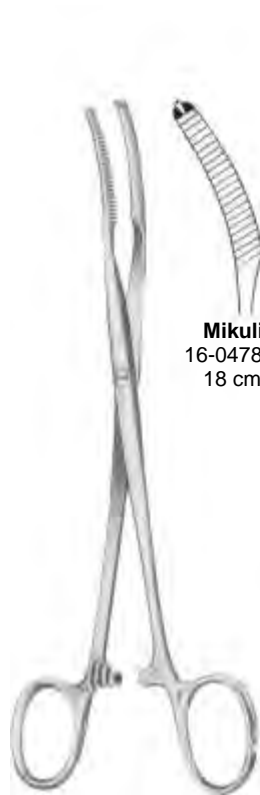

Mikulicz
16-04785-18
18 cm/7"

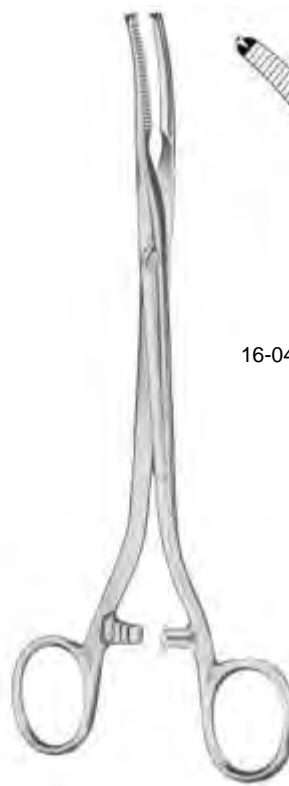

Mikulicz
16-04789-20 20 cm/8" 16-04791-20

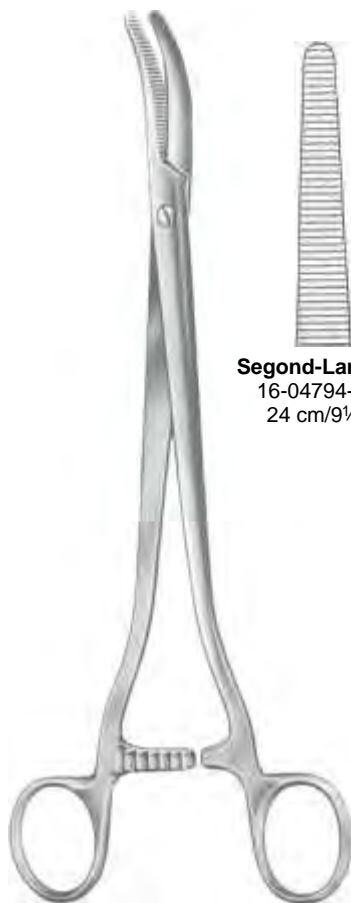

Segond-Landau
16-04794-24
24 cm/9½"



Segond
16-04795-24
24 cm/9½"

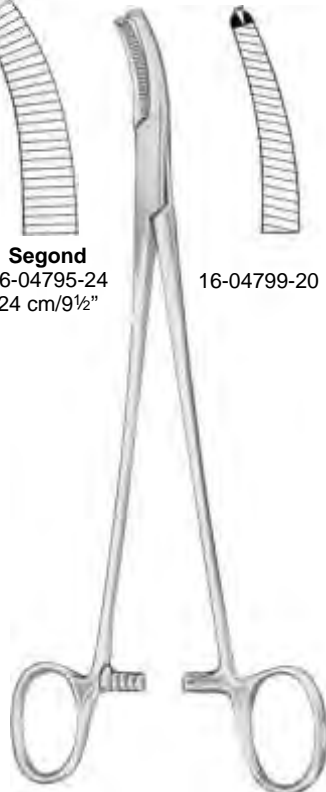

Faure
16-04799-20 20 cm/8" 16-04801-20

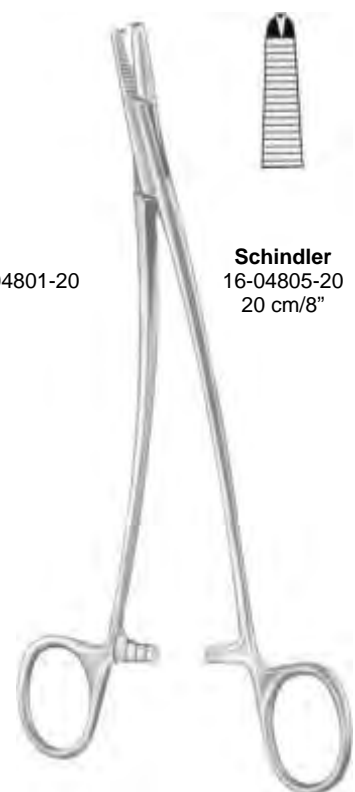

Schindler
16-04805-20
20 cm/8"





Schadel
16-04808-09
9 cm/3½"



Jones
16-04812-05 5 cm/2"
16-04812-09 9 cm/3½"



Engl-Modell
16-04816-09
9 cm/3½"



Backhaus
16-04820-09 9 cm/3½"
16-04820-11 11 cm/4½"
16-04820-13 13 cm/5"
16-04820-15 15 cm/6"

With clip for Tubing or Cable



16-04824-11 11 cm/4½"
16-04824-13 13 cm/5"



Peers-Bertram
16-04828-14
14.5 cm/5¾"



Tohoku
16-04832-10 10 cm/4"
16-04832-13 13 cm/5"



Roder
16-04836-13 13 cm/5"
16-04836-15 15 cm/6"



Lorna
16-04840-10 10 cm/4"
16-04840-13 13 cm/5"



Bernhard
16-04844-16 16.5 cm/6½"



Lane
16-04848-20
20 cm/8"



Doyen
16-04852-18
18 cm/7"



16-04856-14 14 cm/5½"
16-04856-15 15 cm/6"
16-04856-18 18 cm/7"
16-04856-20 20 cm/8"



16-04860-14
14.5 cm/5¾"



16-04864-16 16.5 cm/6½"
16-04864-18 18.0 cm/7"



16-04868-15 15 cm/6"
16-04868-18 18 cm/7"
16-04868-20 20 cm/8"



Mohr
16-04872-50 50 mm
16-04872-60 60 mm
16-04872-70 70 mm
16-04872-80 80 mm

Sizes
mm
13
17
20
25
30



Hoffmann
16-04876-13
16-04876-17
16-04876-20
16-04876-25
16-04876-30



Hoffmann
16-04880-13
16-04880-17
16-04880-20
16-04880-25
16-04880-30



Ulrich

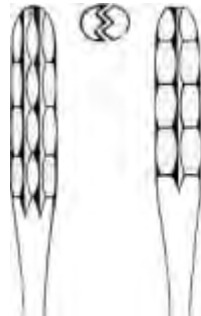

Straight

16-04884-22
16-04884-25
16-04884-27

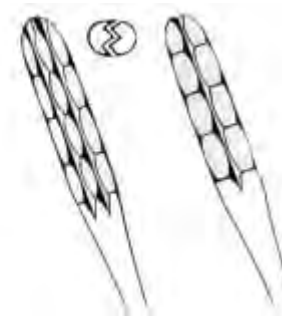

Curved

22 cm/8³/₄" 16-04885-22
25 cm/10" 16-04885-25
27 cm/10¹/₂" 16-04885-27



Lister

16-04888-13	13 cm/5"	16-04890-13
16-04888-15	15 cm/6"	16-04890-15
16-04888-18	18 cm/7"	16-04890-18



Bryant

16-04894-13
13 cm/5"



Bryant

16-04896-13
13 cm/5"



Gross-Maier

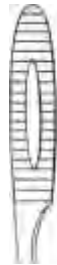

Straight



Curved

With Ratchet

16-04900-20	20 cm/8"	16-04901-20
16-04900-25	25 cm/10"	16-04901-25

Without Ratchet

16-04904-20	20 cm/8"	16-04905-20
16-04904-25	25 cm/10"	16-04905-25



Pelkman
25 cm/10"



16-04908-25



16-04909-25



Sims-Maier
28 cm/11"

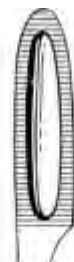

16-04912-28



16-04913-28

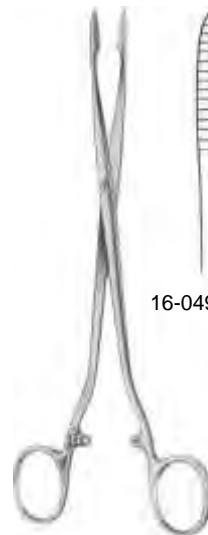

Duplay
20 cm/8"



16-04916-20



16-04917-20



Collin
16-04920-25
25cm/10"

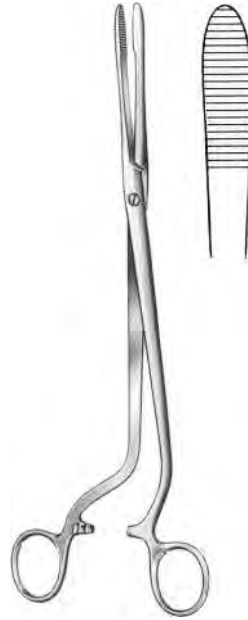

Cheron
16-04924-25
25cm/10"



Emmet
16-04928-21
21cm/8¼"



Bozemann
16-04932-26
26cm/10¼"



Bozemann
26cm/10¼"



16-04935-26



16-04937-26

Smooth



Bozemann-Douglas
16-04941-26
26cm/10¼"

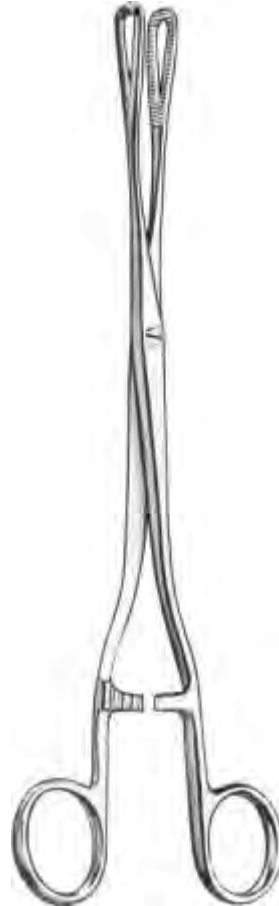

Rampley
16-04944-18 18cm/7"
16-04944-24 24cm/9½"



Rampley
16-04946-18 18cm/7"
16-04946-24 24cm/9½"



Foerster

18 cm/7"
20 cm/8"
24 cm/9½"
25 cm/10"



16-04950-18
16-04950-20
16-04950-24
16-04950-25



16-04951-18
16-04951-20
16-04951-24
16-04951-25



16-04954-18
16-04954-20
16-04954-24
16-04954-25

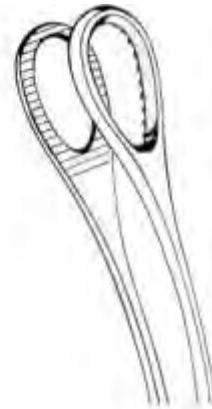

16-04955-18
16-04955-20
16-04955-24
16-04955-25



Schwartz
16-04959-19
19cm/7½"



16-04962-01



16-04962-02



16-04962-03

Applying Forceps



16-04966-23
23cm/9"



Diethrich

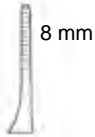

16-04970-08



16-04970-12



16-04970-20



16-04971-08



16-04971-12



16-04971-20

Atrauma



16-04974-10



16-04974-14



16-04974-20



16-04975-10



16-04975-14



16-04975-20

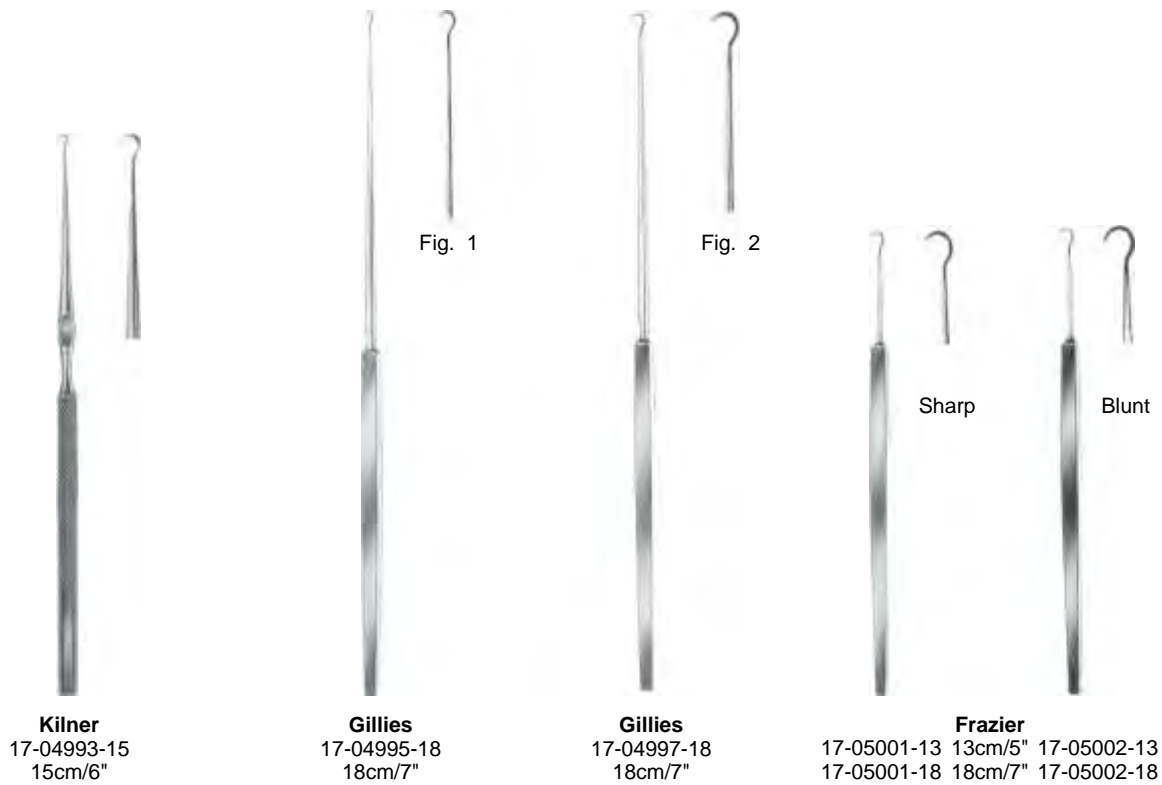
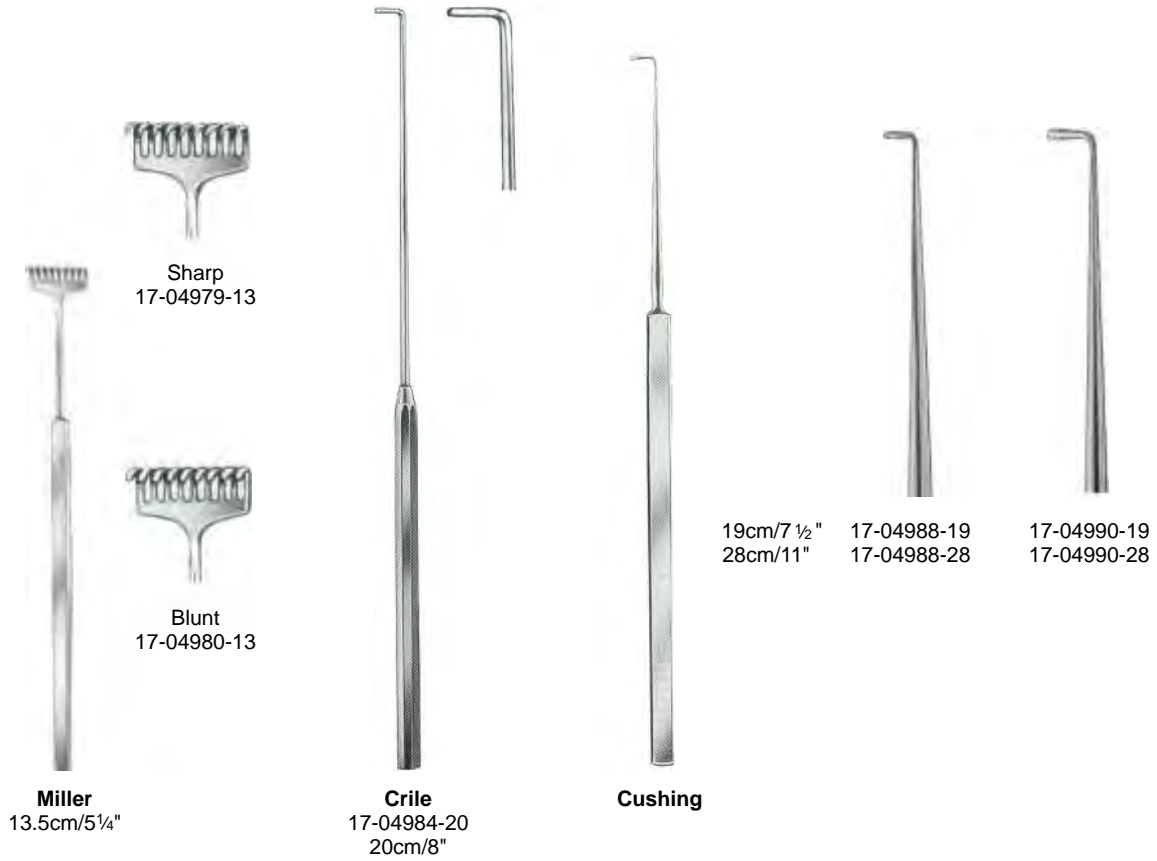

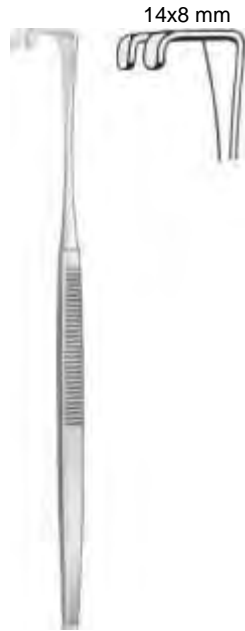

17-05006-16
16cm/6¼"



17-05010-08
8 mm



17-05010-10
10 mm



17-05014-12
12 mm



17-05014-14
14 mm



17-05010-12
12 mm



17-05010-14
14 mm



17-05014-16
16 mm



17-05014-18
18 mm



17-05010-16
16 mm



17-05010-18
18 mm



Sharp



Blunt

Graefe
17-05017-16 16cm/6¼" 17-05018-16



17-05021-16
16cm/6¼"



17-05023-16
16cm/6¼"



O, Connor
17-05025-16
16cm/6¼"



Guthrie
17-05029-16 16cm/6¼" 17-05031-16



17-05035-16
16cm/6¼"



17-05037-16
16cm/6¼"





Malleable



Gil-Vernet
24cm/9½"

08 mm 17-05080-08	17-05082-08
11 mm 17-05080-11	17-05082-11
15 mm 17-05080-15	17-05082-15
17 mm 17-05080-17	17-05082-17
20 mm 17-05080-20	17-05082-20
23 mm 17-05080-23	17-05082-23

Malleable



24cm/9½"

12x14 mm



Little
17-05085-20
20cm/8"



Love-(Morse)
25cm/10"

10 mm 17-05086-10
15 mm 17-05086-15
20 mm 17-05086-20
30 mm 17-05086-30
40 mm 17-05086-40
50 mm 17-05086-50

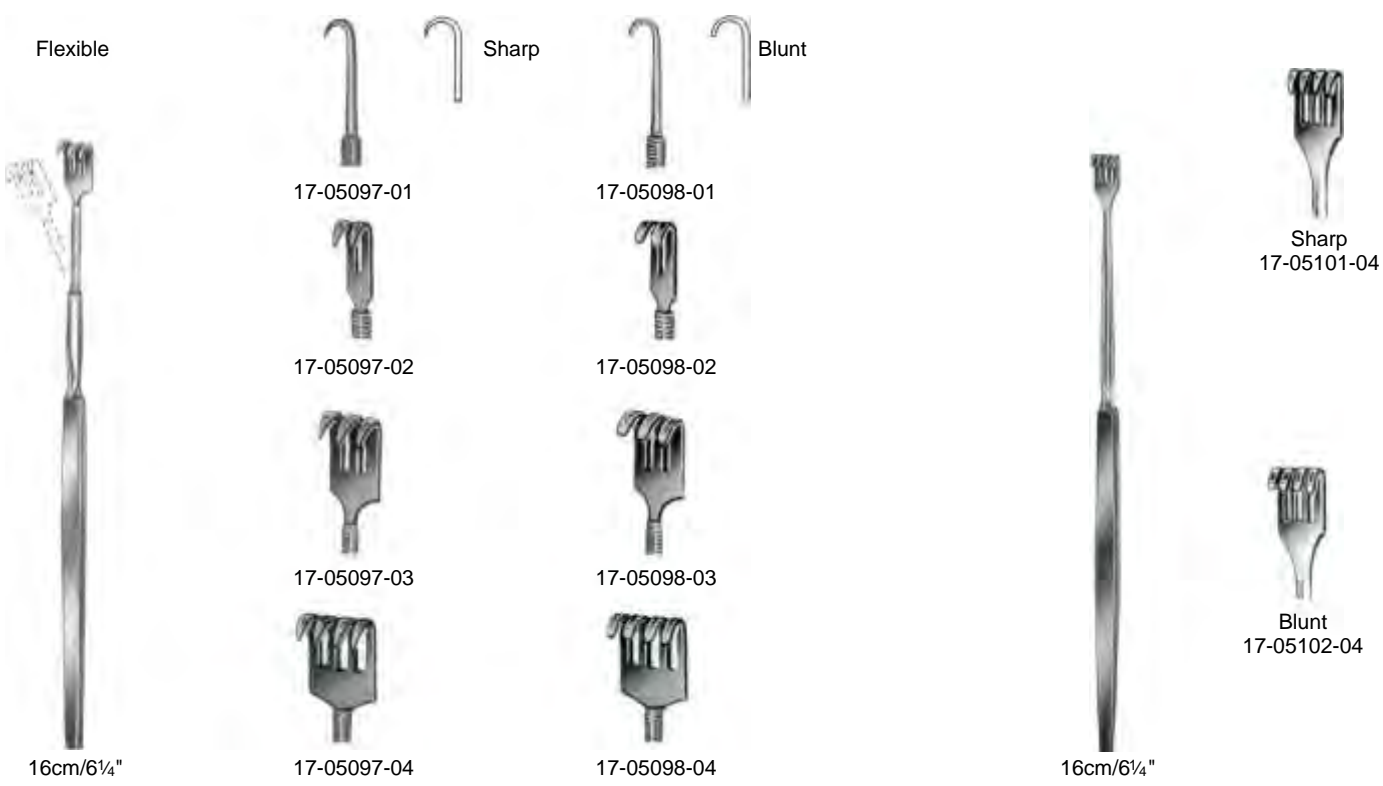
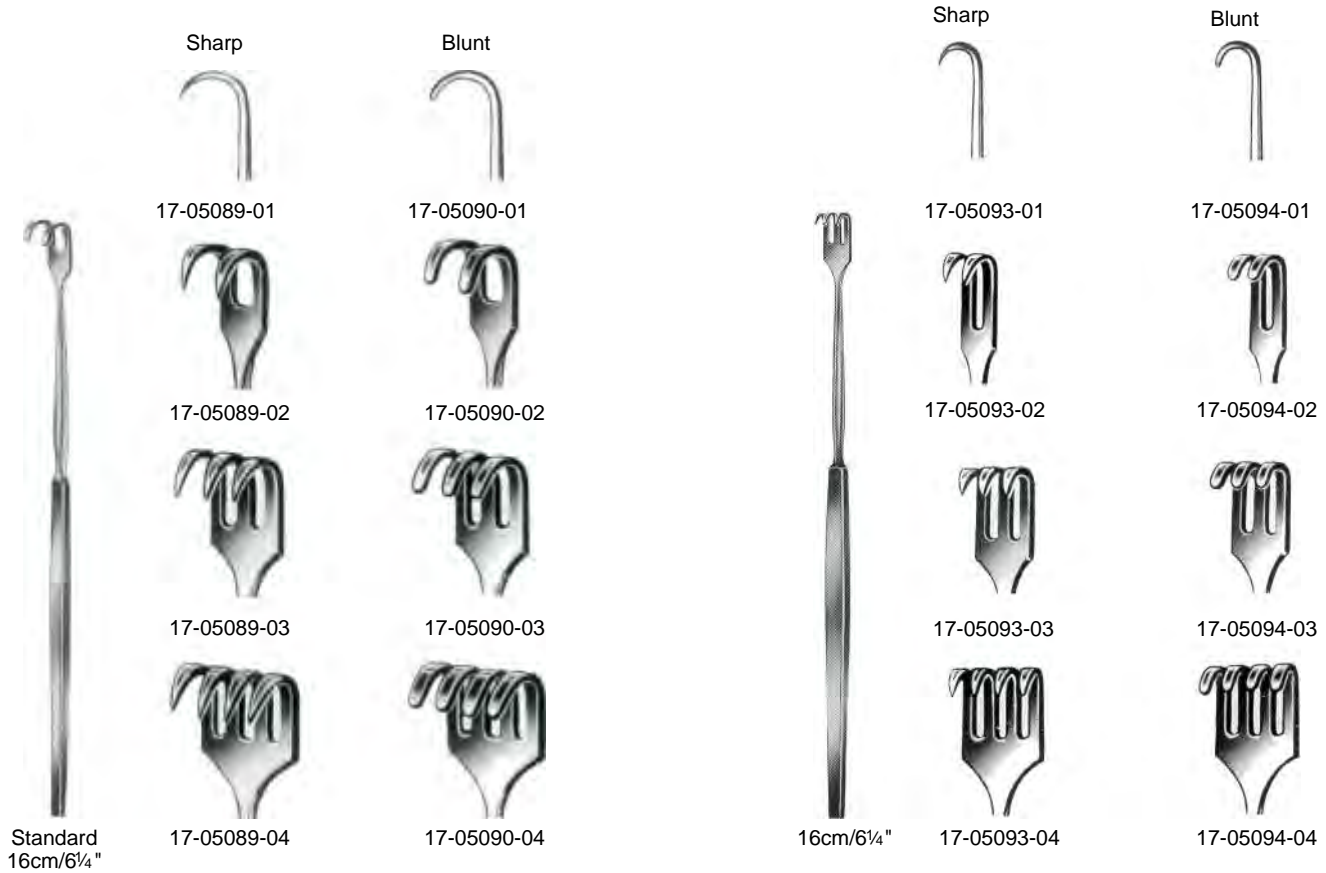



17-05106-02
13.5cm/5¼"



Jackson
17-05109-13
13cm/5"



Bergmann
17-05113-14
14cm/5½"



Iterson
16cm/6¼"



17-05117-16



17-05119-16



Meyerding
18cm/7"



17-05122-18
18x7 mm



17-05128-18
16x5 mm



17-05124-18
7x4 mm



17-05130-18
10x3 mm



17-05126-18
7x4 mm



17-05132-18



Volkman
11.5cm/4½"



Sharp
17-05135-02



Blunt
17-05136-02



17-05135-03



17-05136-03



17-05135-04



17-05136-04



17-05135-06



17-05136-06

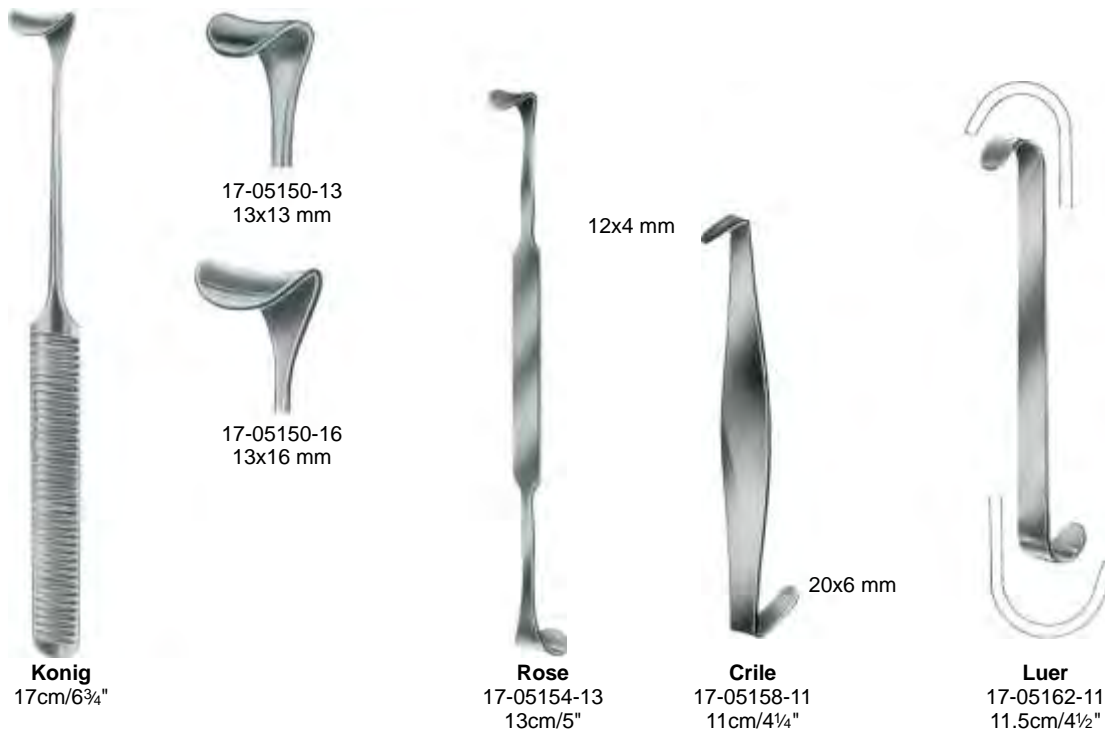
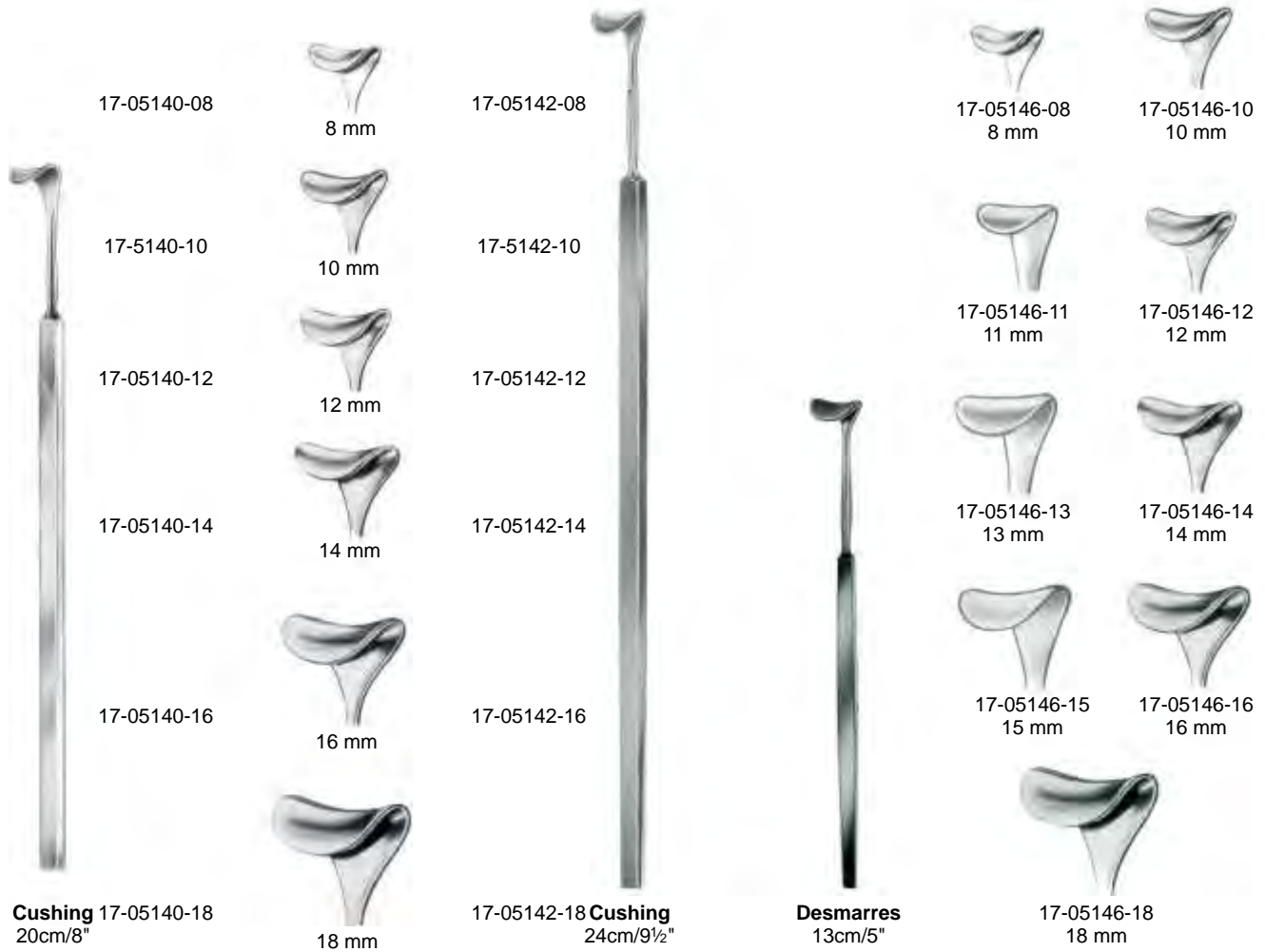

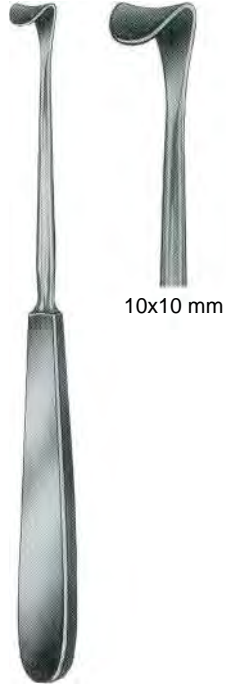

10x10 mm

Cushing-Kocher
17-05166-18
18cm/7"



Langenbeck-Green
17cm/6¾"

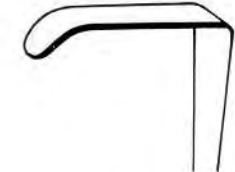

17-05170-17
6x25 mm

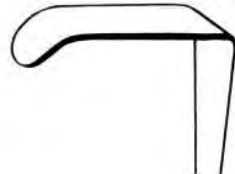

17-05172-17
8x25 mm



Tendon Sheath Hook



17-05176-19



toothed

17-05178-19

Strandell-Stille
19cm/7½"

Tendon Sheath Hook



Klapp
17.5 cm/7"



17-05182-02



17-05182-03



17-05182-04

Decompression Hook



Cushing
17-05186-20
20cm/8"

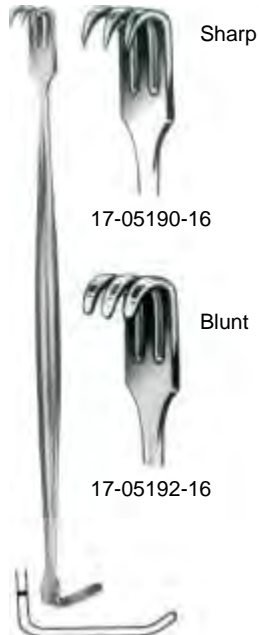

Senn-Miller
16cm/6¼"

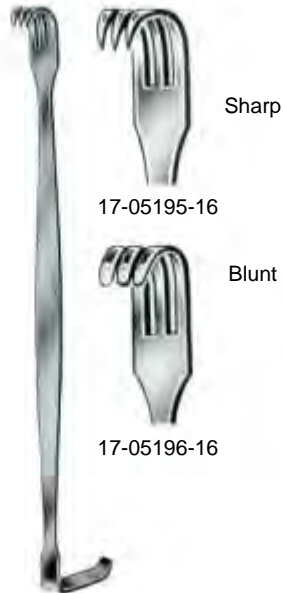

Baby-Senn-Miller
16cm/6¼"



Rangell-Davis
17-05200-14
14cm/5½"



Senn-Green
15cm/6"



Langenbeck-Green
16cm/6¼"



Collin-Hartmann

Roux

Baby-Roux
13 cm/5"

Mini-Roux
14 cm/5½"

Set	17-05214-00	Set	17-05218-00	17-05222-13	17-05224-14
14 cm/5½"	17-05214-01	14 cm/5½" Fig. 1	17-05218-01		
16 cm/6"	17-05214-02	15 cm/6" Fig. 2	17-05218-02		
		17 cm/6¾" Fig. 3	17-05218-03		

37x40 mm



Goelet
17-05228-19
19 cm/7½"

37x31 mm



Parker-Langenbeck (US-Army)
17-05232-21
21cm/8¼"

Set



Parker
17-05236-13
13.5 cm/5¼"

Set



Parker
17-05240-18
18 cm/7"

Set



Set

Parker-Mott
17-05244-16
16 cm/6¼"



Set

Farabeuf
17-05248-12
12 cm/4¾"



Set

Farabeuf
17-05250-15
15 cm/6"



Set

Collin
17-05254-16
16.5 cm/6½"



Set

Mayo-Collin
17-05256-15
15 cm/6"



Set

Mathieu
17-05260-19
19 cm/7½"

General Instruments Retractors and Bone Retractors

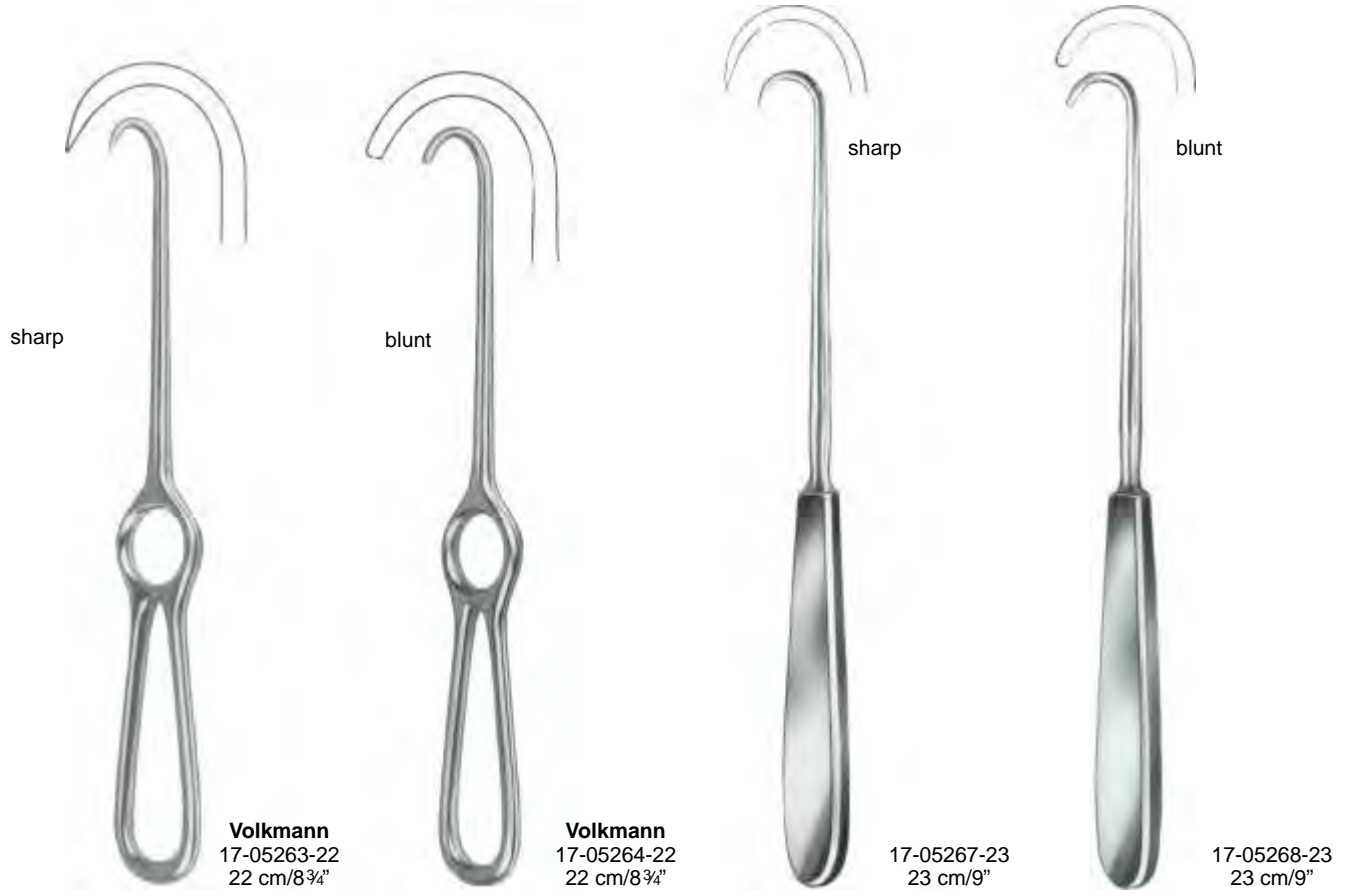



Volkmann
23 cm/9"



Sharp

17-05279-01

9x8 mm



17-05279-02

9x13 mm



17-05279-03

9x19 mm



17-05279-04

9x29 mm



17-05279-06



blunt

17-05280-01



17-05280-02



17-05280-03



17-05280-04



17-05280-06



Semi-sharp

17-05281-01



17-05281-02



17-05281-03



17-05281-04



17-05281-06

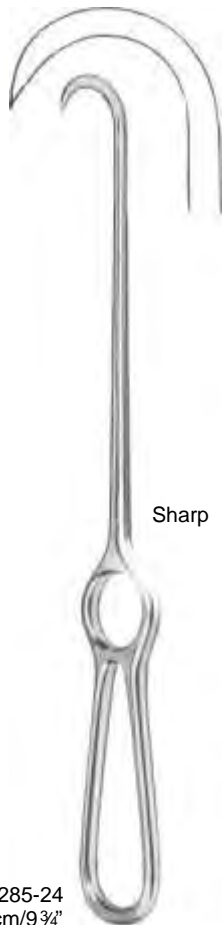

Sharp

17-05285-24
24.5 cm/9³/₄"



Sharp

Kocher
17-05287-21
21.5 cm/8¹/₂"



Blunt

Kocher
17-05288-21
21.5 cm/8¹/₂"



Sharp

Kocher
17-05291-21
21.5 cm/8¹/₂"

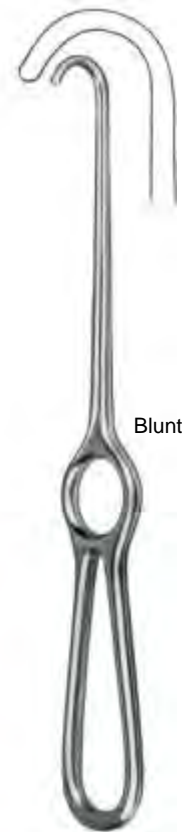



















Blunt

Kocher
17-05292-21
21.5 cm/8¹/₂"



Kocher
21.5cm/8½"

		15x10 mm	15x15 mm	15x20 mm	15x30 mm	15x40 mm
sharp						
	17-05295-01	17-05295-02	17-05295-03	17-05295-04	17-05295-06	17-05295-08
blunt						
	17-05296-01	17-05296-02	17-05296-03	17-05296-04	17-05296-06	17-05296-08
semi-sharp						
	17-05297-01	17-05297-02	17-05297-03	17-05297-04	17-05297-06	17-05297-08



sharp

17-5301-20
20 cm/8"



blunt

17-5302-20
20 cm/8"

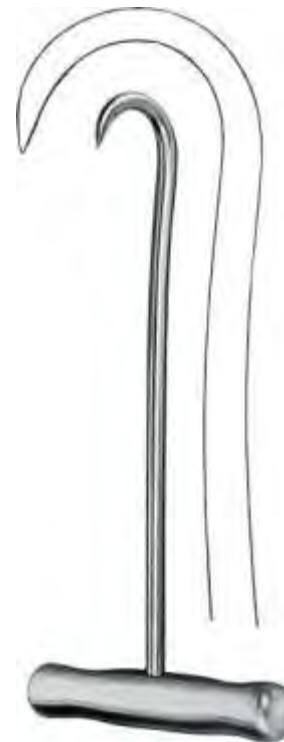

sharp

17-5305-14
14 cm/5½"



17-05308-03
36x30 mm



17-05308-04
36x60 mm

Ollier
22.5 cm/9"



Murphy
19.5 cm/7 3/4"

Sharp



17-05311-02



17-05311-03



17-05311-04



17-05311-06

blunt



17-05312-02



17-05312-03



17-05312-04



17-05312-06



Wassmund
17-05316-20
20cm/8"



17-05320-02
40x50 mm

Israel
25cm/10"



17-05320-01
40x40 mm



17-05320-03
50x60 mm



17-05320-04
70x70 mm



46x55 mm

Vertical Handle
17-05324-23

Koerte
23cm/9"



General Instruments Retractors

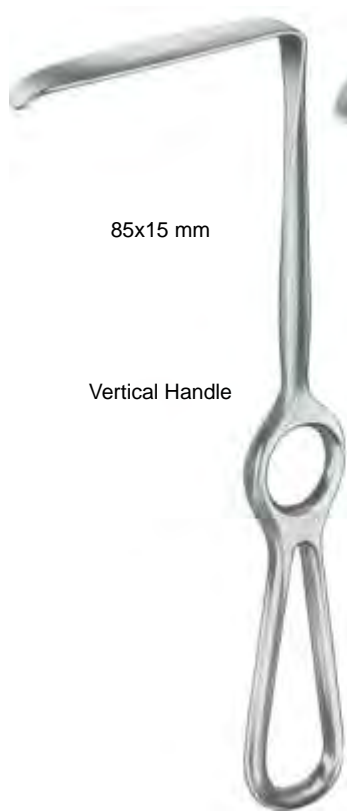

85x15 mm

Vertical Handle

Langenbeck
17-05340-21
21.5cm/8½"



17-05344-01
55x20 mm
17-05344-02
63x20 mm
17-05344-03
60x20 mm

Langenbeck
21cm/8¼"



17-05348-01
35x7 mm
17-05348-02
35x10 mm
17-05348-03
35x15 mm
17-05348-04
60x20 mm

Langenbeck
21cm/8¼"



17-05352-19
28x6 mm

Lahey
19cm/7½"



23cm/9"

Sauerbruch
17-05356-01 45x15 mm
17-05356-02 55x23 mm
17-05356-03 72x20 mm



Langenbeck
21cm/8¼"

17-05360-01 30x11 mm 17-05364-01
17-05360-02 30x14 mm
17-05360-03 33x14 mm
17-05360-04 30x16 mm
17-05360-05 40x11 mm 17-05364-05
17-05360-06 42x13 mm 17-05364-06
17-05360-07 50x11 mm



Langenbeck
22cm/8¾"

38x20 mm



Kocher
17-05368-22
22cm/8¾"

17-05372-01
19x12 mm
17-05372-02
21x15 mm



Kocher
19cm/7½"

17-05376-01 25x06 mm
17-05376-02 25x08 mm
17-05376-03 35x08 mm
17-05376-04 35x11 mm
17-05376-05 35x15 mm
17-05376-06 40x11 mm
17-05376-07 55x11 mm
17-05376-08 70x14 mm
17-05376-09 80x12 mm
17-05376-10 80x16 mm



Kocher-Langenbeck
21.5cm/8½"

67x17cm



Casper
17-05380-21
21.5cm/8½"

17-05388-01
22x15 mm



17-05388-02
38x20 mm



17-05388-03
67x25 mm



17-05388-04
100x35 mm



17-05384-01
40x18 mm
17-05384-02
60x20 mm
17-05384-03
60x25 mm
17-05384-04
75x30 mm
17-05384-05
75x40 mm

Kocher
23cm/9"



Kocher-Wagner
28cm/11"



17-05392-01
60x20 mm
17-05392-02
80x30 mm
17-05392-03
100x30 mm
17-05392-04
120x30 mm
17-05392-05
140x30 mm
17-05392-06
140x40 mm

Heesel
25cm/10"





130x60 mm

St. Marks
17-05396-29
29cm/11½"

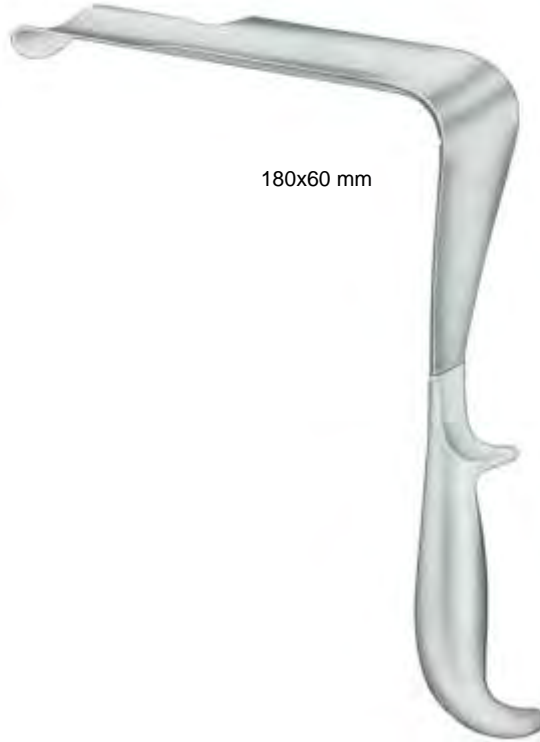

180x60 mm

St. Marks
17-05396-32
32.5cm/12¾"

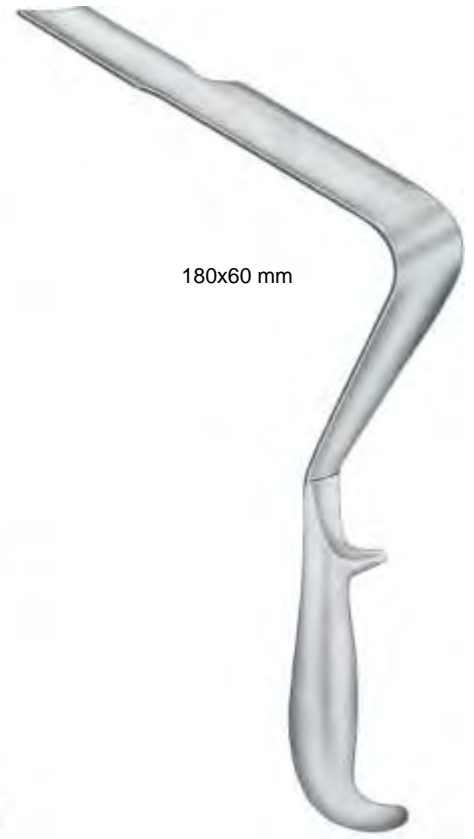

180x60 mm

St. Marks
17-05396-33
33cm/13"



17-05400-01
70x40 mm
17-05400-02
70x50 mm
17-05400-03
70x65 mm

Morris
21cm/8¼"



17-05402-01
32x50 mm/38x50mm
17-05402-02
45x50 mm/50x50mm
17-05402-03
65x50 mm/38x50mm

Morris
24cm/9½"

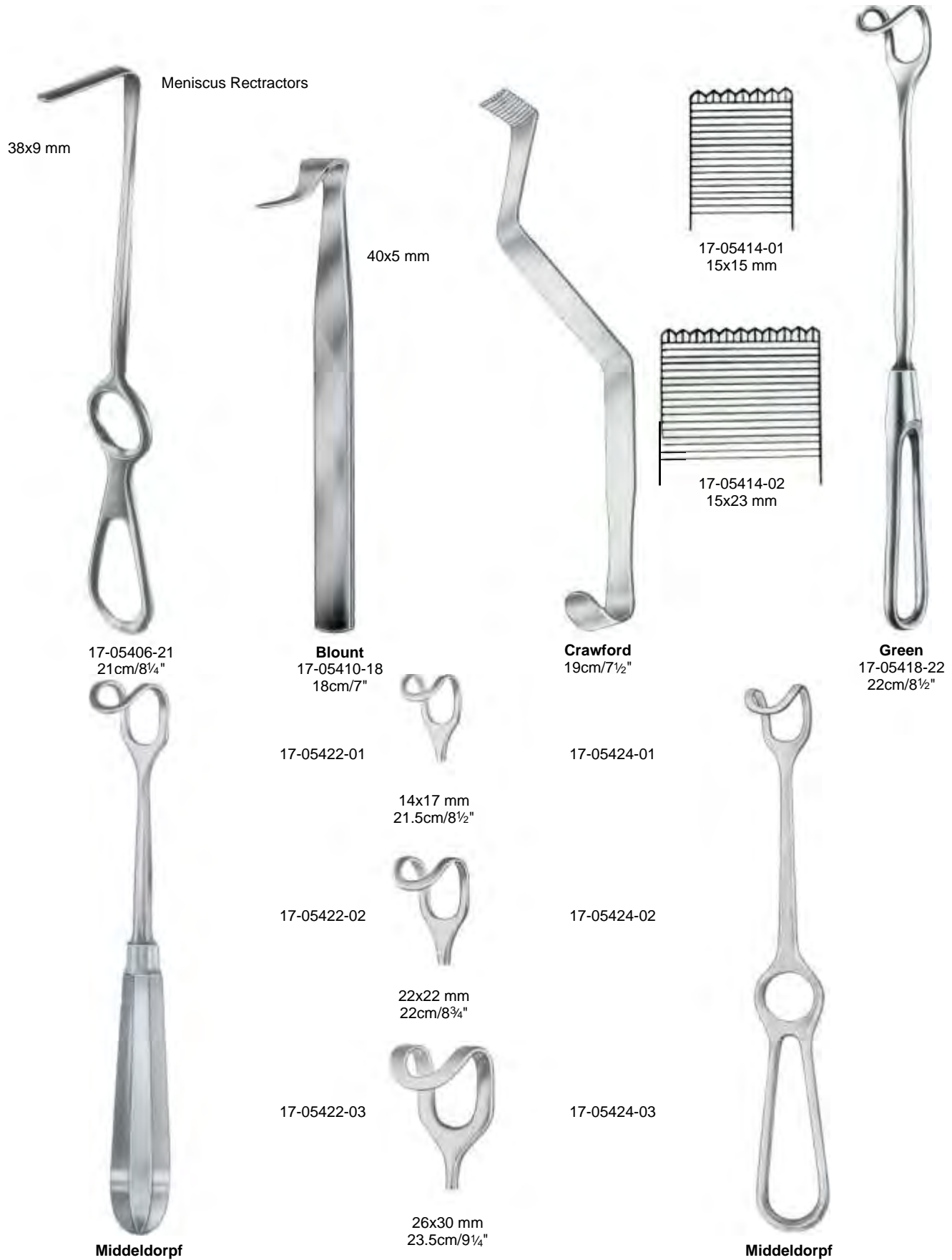



17-05426-01
45x45 mm

Middeldorpf
25.5cm/10"

- 17-05426-01
45x45 mm
- 17-05426-02
45x50 mm
- 17-05426-03
55x70 mm



Richardson
26cm/10¼"



17-05430-01
28x20 mm

17-05430-02
30x28 mm

17-05430-03
38x37 mm

17-05430-04
52x22 mm



49x38 mm
28x20 mm

Fig. 1 ▶

◀ Fig. 2

36x28 mm
71x43 mm

Richardson-Eastman

Set 17-05434-00

Fig. 1
26cm/10¼" 17-05434-01

Fig. 2
28cm/11" 17-05434-02



Kelly
26cm/10¼"

- 17-05438-01
40x50 mm
- 17-05438-02
50x65 mm
- 17-05438-03
65x75 mm
- 17-05438-04
75x90 mm

General Instruments Retractors

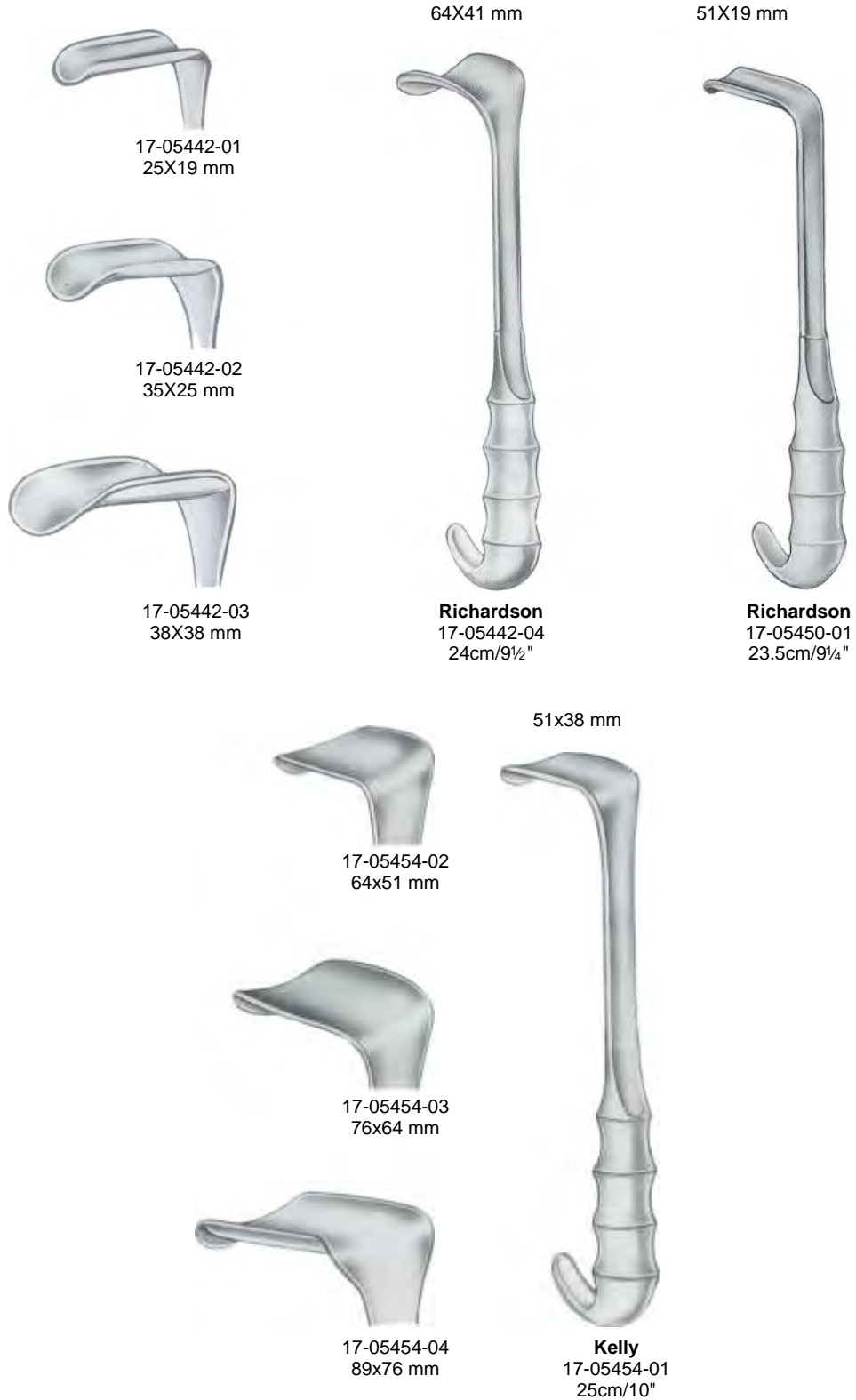

17-05458-01
45x40 mm
17-05458-02
45x50 mm
17-05458-03
45x60 mm
17-05458-04
45x75 mm
17-05458-05
65x85 mm

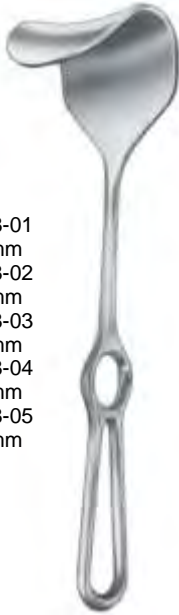

Fritsch
24cm/9½"

50x85 mm

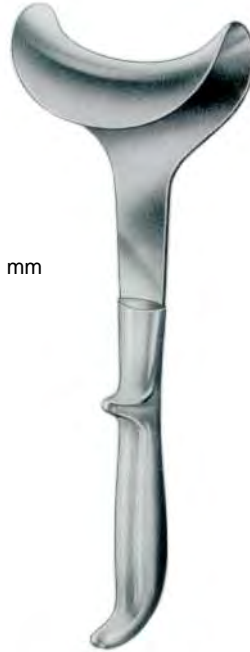

Doyen
17-05462-25
25cm/10"

17-05466-01
15x90 mm
17-05466-02
20x90 mm
17-05466-03
30x90 mm
17-05466-04
35x110 mm
17-05466-05
40x110 mm
17-05466-06
55x120 mm

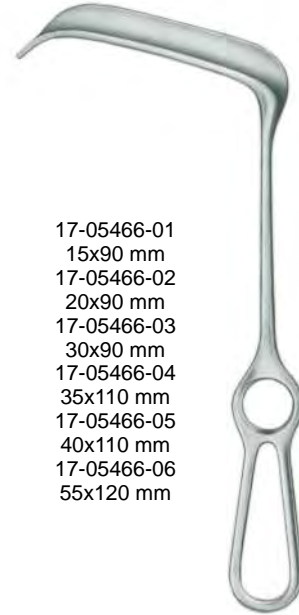

Doyen-Stillé
24cm/9½"

70x25 mm



Kocher
17-05470-22
22.5cm/9"

17-05472-01
80x42 mm
17-05472-02
80x50 mm
17-05472-03
80x60 mm

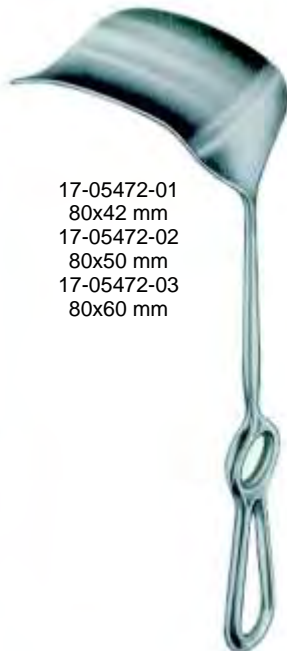

Kocher
25cm/10"

60x60 mm



Tuffier
17-05476-23
23cm/9"

17-05480-01
115x22 mm
17-05480-02
115x27 mm

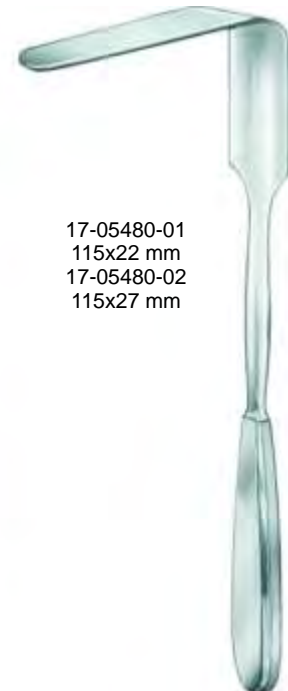

Simon
28cm/11"

General Instruments Retractors and Liver Retractors



95x20 mm

Tuebingen
17-05484-28
28cm/11"



105x27 mm

Martin
17-05488-26
26cm/10¼"

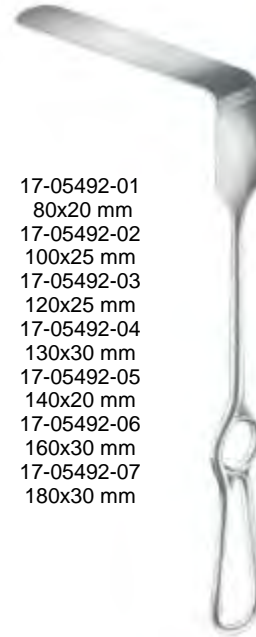

17-05492-01
80x20 mm
17-05492-02
100x25 mm
17-05492-03
120x25 mm
17-05492-04
130x30 mm
17-05492-05
140x20 mm
17-05492-06
160x30 mm
17-05492-07
180x30 mm

Brunner
25cm/10"

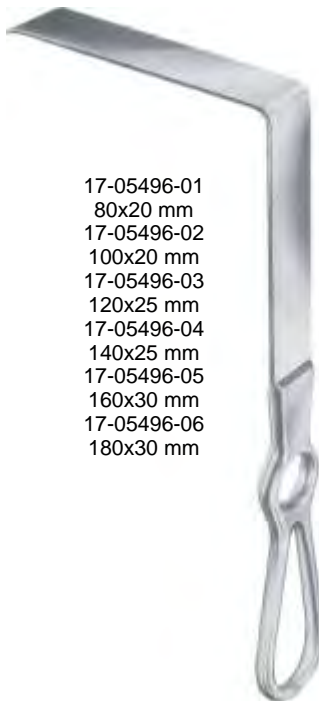

17-05496-01
80x20 mm
17-05496-02
100x20 mm
17-05496-03
120x25 mm
17-05496-04
140x25 mm
17-05496-05
160x30 mm
17-05496-06
180x30 mm

Brunner
25cm/10"



17-05500-01
85x35 mm
17-05500-02
120x50 mm
17-05500-03
155x50 mm

Mikulicz
26cm/10¼"



90x50 mm

Mikulicz
17-05502-26
26cm/10¼"

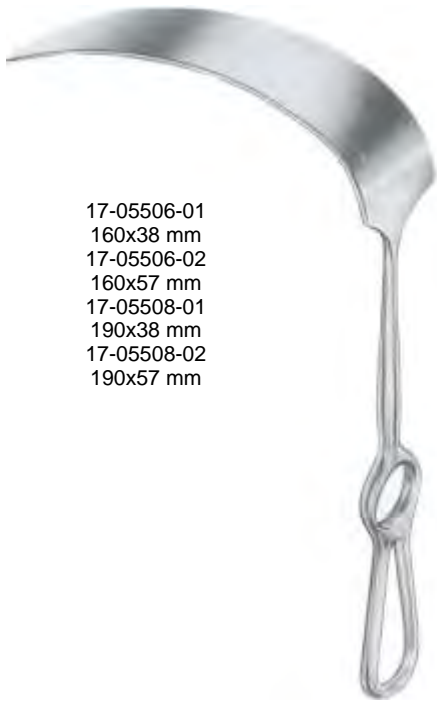

17-05506-01
160x38 mm
17-05506-02
160x57 mm
17-05508-01
190x38 mm
17-05508-02
190x57 mm

Kelly
27cm/10½"



Polloson
17-05510-27
27cm/10½"



Polloson
17-05512-27
27cm/10½"



17-05516-03
115x65 mm

17-05516-02
115x38 mm

17-05516-01
82x20 mm

Coryllos
23.0cm/9"



17-05520-25
130x38 mm

Sauerbruch
25cm/10"

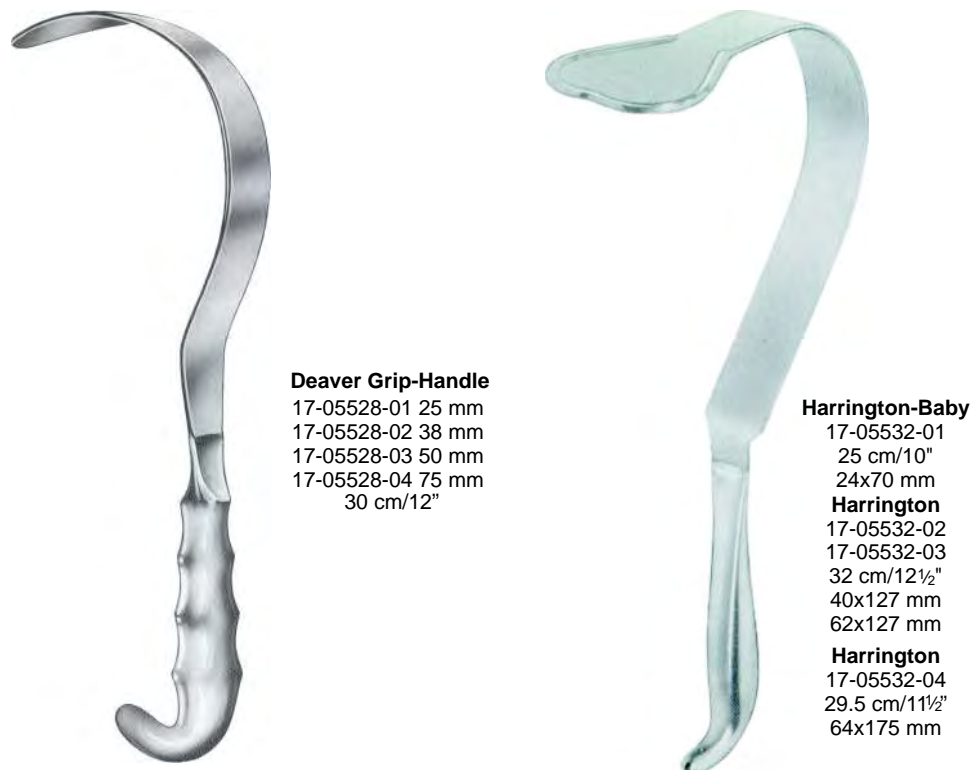



17-05536-01
50x16 mm
17-05536-02
75x25 mm
17-05536-03
90x50 mm

Meyerding
22.5cm/9"



Zenker

17-05540-01 25cm/10" 35x08 mm
17-05540-02 26cm/10¼" 60x12 mm
17-05540-03 27.5cm/10¾" 75x12 mm

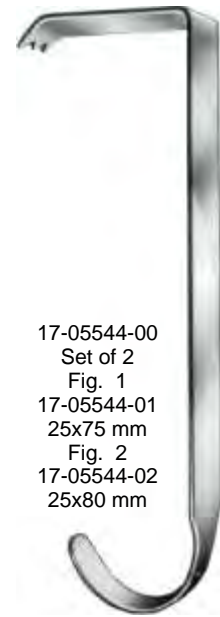

17-05544-00
Set of 2
Fig. 1
17-05544-01
25x75 mm
Fig. 2
17-05544-02
25x80 mm

Hibbs
24cm/9½"



17-05548-01
45x25 mm
17-05548-02
73x28 mm
17-05548-03
82x28 mm

Heaney
27cm/10½"



46 mm

Kuemmel
17-05552-33
33cm/13"



100x45 mm

rigid

Koerte
17-05556-28
28cm/11"

General Instruments Abdominal and Intestinal Spatulas

17-05560-20
20 mm
17-05560-30
30mm
17-05560-40
40 mm



Kader
27cm/10½"



17-05564-01
25.5cm/10"
45 mm
17-05564-02
27.5cm/10¾"
60 mm

Leriche



Malleable
17-05568-01 20 mm
17-05568-02 25 mm
17-05568-03 30 mm
17-05568-04 35 mm
17-05568-05 40 mm
17-05568-06 45 mm
17-05568-07 50 mm
17-05568-08 64 mm
17-05568-09 76 mm
17-05568-10 102 mm
33cm/13"

Malleable



Tuffier
17-05570-20
20 cm/8"
17x25 mm

Malleable

17-05572-01
200x6 mm
17-05572-02
200x8 mm
17-05572-03
200x10 mm
17-05572-04
200x12 mm
17-05572-05
200x17 mm
17-05572-06
200x20 mm
17-05572-07
200x25 mm
17-05572-08
250x25 mm



20cm/8"

Malleable

17-05574-01
280x25/30 mm
17-05574-02
300x37/45 mm
17-05574-03
300x40/50 mm



Haberer
21cm/8¼"



Reverdin
17-05578-28
28 cm/11"



Davidson
16cm/6¼"

75x50 mm 17-05582-01
75x90 mm 17-05582-02



Cooley
17-05586-01
21.5cm/8½"

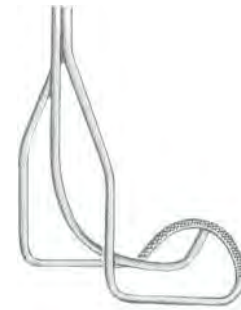

Cooley
17-05586-02
21.5cm/8½"



Cooley
17-05586-03
23cm/9"



Ross
27cm/10½"

- Fig. 1 17-05590-01 13x13 mm
- Fig. 2 17-05590-02 14x12 mm
- Fig. 3 17-05590-03 18x18 mm
- Fig. 4 17-05590-04 20x20 mm
- Fig. 5 17-05590-05 22x18 mm
- Fig. 6 17-05590-06 26x24 mm

General Instruments Retractors for Maxillofacial Surgery





22cm/8¾"



17-05608-01
25x7 mm



17-05608-02
31x10 mm



17-05608-03
42x11 mm



17-05608-04
55x12 mm



17-05608-05
70x14 mm



17-05608-06
80x18 mm



22cm/8 $\frac{3}{4}$ "



17-05612-01
42x13 mm



17-05612-02
60x12 mm



17-05612-03
80x16 mm



Spina-Nasalis
17-05616-01
22 cm/8¾"

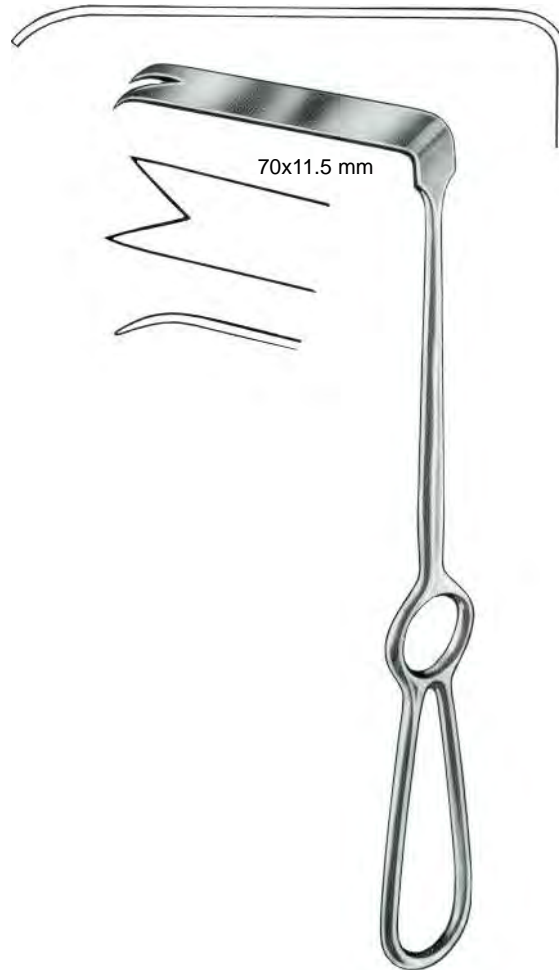

Ramus
17-05616-02
22 cm/8¾"



17-05620-15
15.5 cm/6"



17-05624-16
16 cm/6¼"



17-05627-10 10 mm
17-05627-20 20 mm
19cm/7½"



Dingman
17-05629-17
17.5cm/7"



Soeresen-Hein
17-05632-17
17.5cm/7"



Dingman
17-05636-21
21cm/8¼"



17-05640-18
18.5cm/7¼"

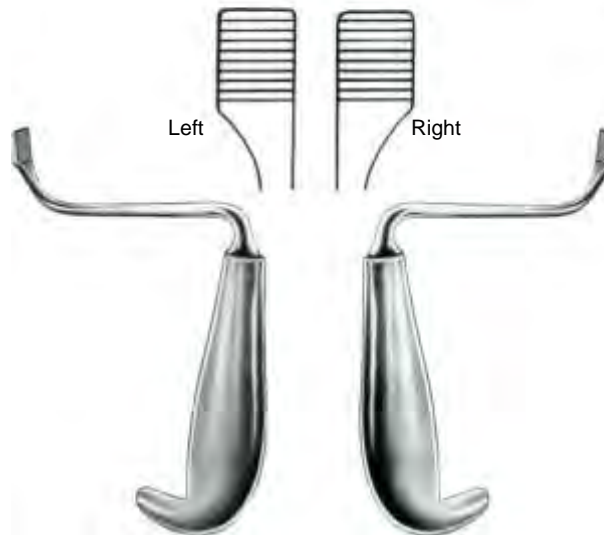

Tessier
17-05644-01
15cm/6"

Tessier
17-05646-02
15cm/6"



Dingman
17-05648-00



17-05652-21
21cm/8¼"



17-05658-20
20.5cm/8"



17-05662-17
17.5cm/7"

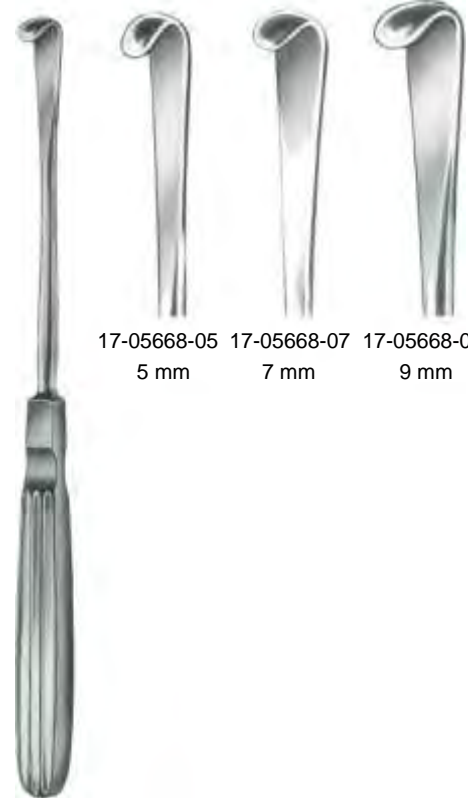

17-05668-05 17-05668-07 17-05668-09
5 mm 7 mm 9 mm

20cm/8"



17.5cm/7"



17-05672-06
6 mm



17-05672-07
7 mm



17-05672-09
9 mm



17-05672-11
11 mm



Dingman
17-05676-18
18cm/7"



17-05680-23
23.5cm/9¼"
10 mm

General Instruments Osteotome for Maxillofacial Surgery



Tessier
20.5cm/8"



17-05686-10
10 mm



17-05687-10
10 mm



17-05690-01
18.5cm/7¼"



17-05690-02
18.5cm/7¼"



17-05694-07
7 mm
21.5cm/8½"



17-05694-10
10 mm
21.5cm/8½"



17-05698-02
2.5 mm



17-05698-04
4 mm

15cm/6"



Bowdler-Henry's
17-05702-16
16.5cm/6½"



Gillies
17-05706-21
21cm/8¼"



Gillies
17-05708-21
21cm/8¼"



Sanders-Brown
17-05712-30
30cm/12"



Sanders-Brown
17-05716-29
29cm/11½"



17-05720-14
14cm/5½"



17-05722-23
23cm/9"



17-05724-18
18cm/7"



Kelsey-Fry
17-05728-18
18cm/7"



Band Pusher



Kelsey-Fry
17-05726-15
15cm/6"

Mershon
17-05732-14
14.5cm/5½"

General Instruments Retractors



Bose



Finsen

Sharp



Finsen

Blunt

Sharp

cm	in				
5	2		17-05739-05		17-05740-05
7	2¾"	17-05736-07	17-05739-07	17-05740-07	17-05743-07

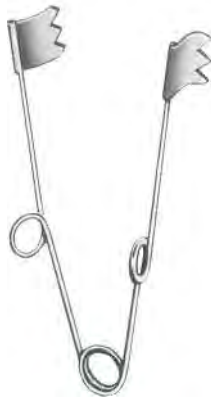

Allport
17-05750-09
9.5cm/3¾"

Sharp



Alm

Blunt

cm	in		cm	in		
8.5	3½"	17-05746-08	7	2¾"	17-05753-07	17-05756-07
11.5	4½"	17-05746-11	10	4	17-05753-10	17-05756-10



Holzheimer
Sharp 17-05759-10 10 cm/4"
blunt 17-05760-10



Jansen
Sharp 17-05763-10 10.5 cm/4 1/4"
blunt 17-05764-10



Jansen-Deep
Sharp 17-05767-10 10.5 cm/4 1/4"
blunt 17-05768-10



Plester
17-05772-11
11.5 cm/4 1/2"



Plester
17-05774-11
11.5 cm/4 1/2"



Plester
Sharp 17-05777-13 13 cm/5"
blunt 17-05778-13

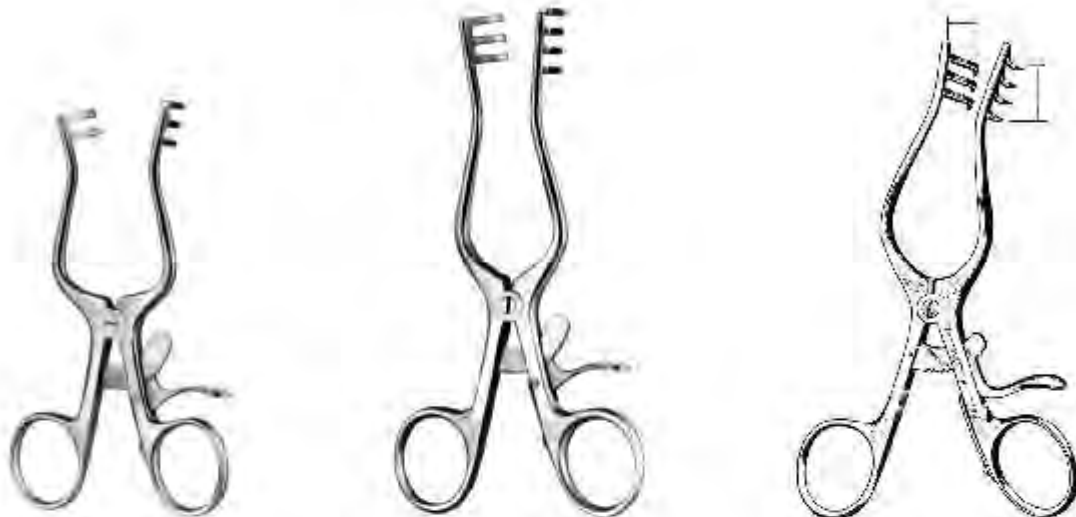

	Weitlaner		Weitlaner		Weitlaner-Wullstein	
	Sharp	Blunt	Sharp	Blunt	Sharp	Blunt
10.5 cm/4¼"	17-05781-10	17-05782-10				
13.0 cm/5"	17-05781-13	17-05782-13	17-05785-13	17-05786-13	17-05789-13	17-05790-13
14.0 cm/5½"	17-05781-14	17-05782-14	17-05785-14	17-05786-14	17-05789-14	17-05790-14
16.5 cm/6½"	17-05781-16	17-05782-16	17-05785-16	17-05786-16	17-05789-16	17-05790-16



Complete with 2 pairs of blades and centre blade

Mollison
17-05793-15
15 cm/6"

Tuebinger-Modell
17-05796-16
16 cm/6¼"

Henner(Lempert)
17-05800-12
12 cm/4½"

Complete with 3 Central blades



Henley

Sharp		Blunt
17-05803-16	16.5 cm/6½"	17-05804-16

Central blades, only



17-05805-19	17-05805-25	17-05805-32
16x19 mm	16x25 mm	16x32 mm



Weitlaner-Baby

13 cm/5"	17-05808-13
16 cm/6¼"	



Milligan

Sharp	Blunt
17-05811-13	17-05812-13



Cone (Adson-Baby)

Sharp	Blunt
17-05815-13	17-05816-13
17-05815-16	17-05816-16



Weitlaner



3x4 Teeth



5x6 Teeth

	Sharp	Blunt	Sharp	Blunt
20 cm/8"	17-05819-20	17-05820-20		
25 cm/10"	17-05819-25	17-05820-25	17-05821-25	17-05822-25



Adson



Anderson-Adson



Cone

	Sharp	Blunt	Sharp	Blunt	Sharp	Blunt
20 cm/8"	17-05823-20	17-05824-20	17-05827-20	17-05828-20	17-05831-20	17-05832-20
26 cm/10¼"	17-05823-26	17-05824-26			17-05831-26	17-05832-26



Travers
17-05836-21
21 cm/8¼"

Jaws Depth

25 mm
44 mm

Beckmann-Adson
31 cm/12¼"

Sharp Blunt

17-05839-01
17-05839-02

17-05840-01
17-05840-02

Adson
27 cm/10½"

Sharp
17-05843-27

Blunt
17-05844-27

5x6 Teeth



Adson
Sharp 17-05847-27 27cm/10½"
Blunt 17-05848-27



**Beckmann-Adson
(Standard)**
Sharp 17-05851-31 31cm/12¼"
Blunt 17-05852-31



Adson
17-05856-33 33cm/13"

Hemilaminectomy Retractor



17-05861-27
27cm/10½"



Beckmann-Eaton
17-05864-33
33 cm/13"

Retractor Only 17-05868-01
Lateral Blades 17-05868-02

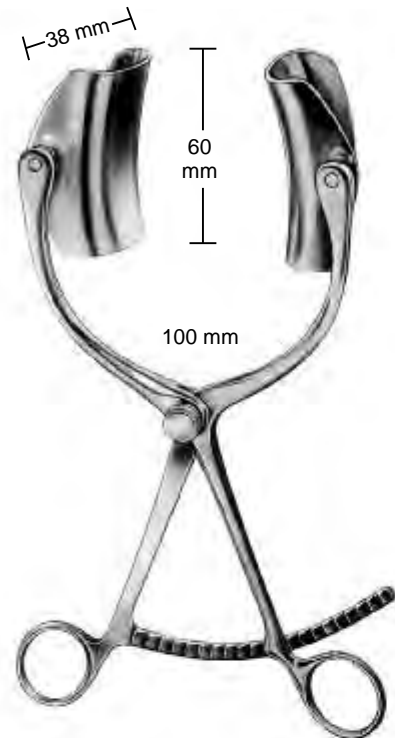

Collin
17-05868-00
20cm/8"

General Instruments Abdominal Retractors

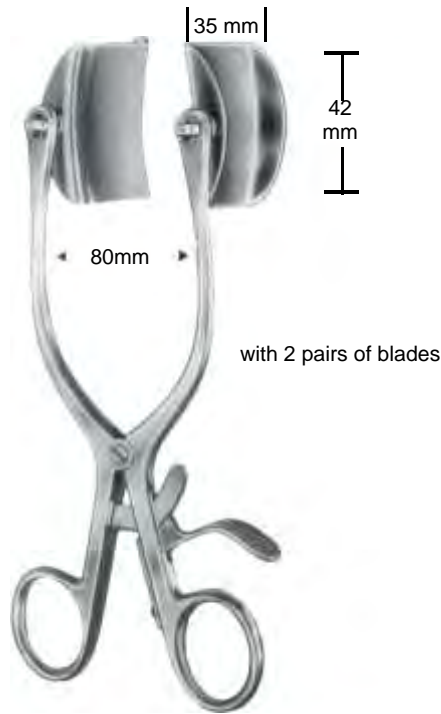

Baby-Collin
17-05872-00

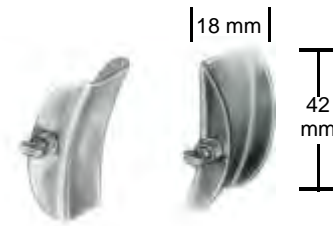

17-05872-01



Collin
20 cm/8"

	Fig. 1	Fig. 2	Fig. 3
Retractors Complete	17-05876-00	17-05878-00	17-05880-00
Retractors Only	17-05876-01	17-05878-01	17-05880-01
Lateral Blades	17-05876-02 38x62 mm	17-05878-02 38x80 mm	17-05880-02 38x100 mm
Central Blades	17-05876-03 55x55 mm		17-05880-03 55x75 mm

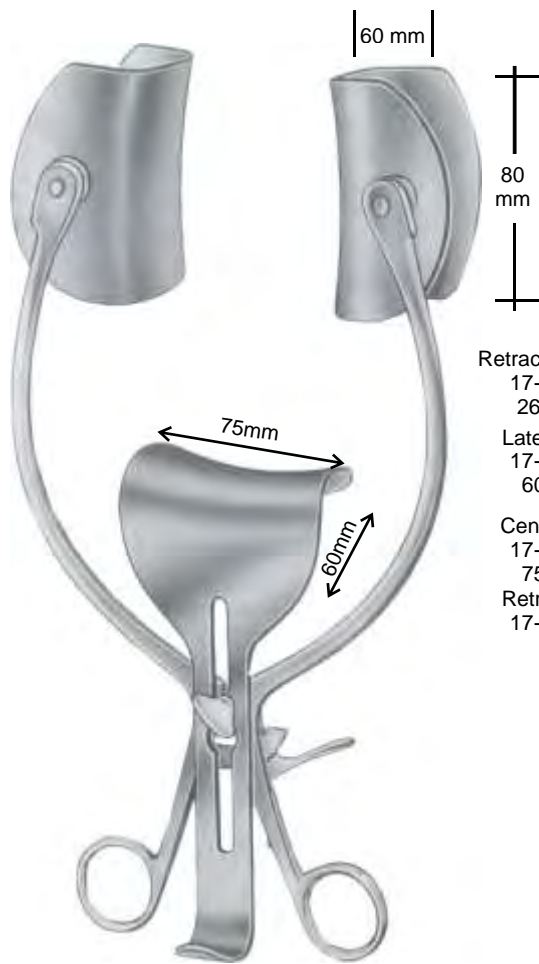

Retractor Complete
17-05884-00
26cm/10½"
Lateral Blades
17-05884-01
60X80mm
Central Blades
17-05884-02
75X60mm
Retractor Only
17-05884-03



Mayo-Adams
17-05886-01
17cm/6¾"

Mayo-Adams
17-05886-02
17cm/6¾"

Collin

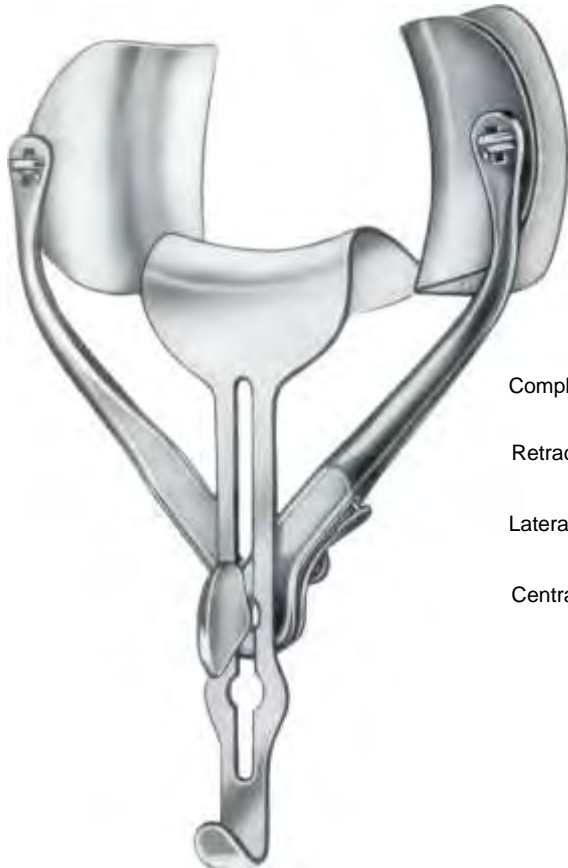

Ricard
17-05890-00 28cm/11"
17-05894-00 30cm/12"

	Fig. 1 17-05890-00	Fig. 2 17-05894-00
Complete		
Retractors Only	17-05890-01	17-05894-01
Lateral Blades	17-05890-02 60x80 mm	17-05894-02 75x85 mm
Central Only	17-05890-03 53x70 mm	17-05894-03 80x90 mm

Vulval Retractor



Richter
17-05898-16
16.5 cm/6½"



Gelpi
17-05902-09 9 cm/3½"
17-05902-11 11 cm/4½"
17-05902-13 13 cm/5"
17-05902-19 19 cm/7½"



Gelpi
17-05904-19
19 cm/7½"



Meyerdung
Fig. 1 17-05908-01
Fig. 2 17-05908-02
Fig. 3 17-05908-03
Fig. 4 17-05908-04
18 cm/7"

Blades

- Fig. 1 1¾"x1"
- Fig. 2 2½"x1"
- Fig. 3 2¾"x1¾"
- Fig. 4 2¾"x1"



Markham-Meyering

17-05912-18 18cm/7" 17-05914-18

Rigby

17-05918-19
19cm/7½"

De Bakey

17-05922-12 12cm/4¾"
17-05922-17 17cm/6¾"



Gosset
17-05926-00

Fig.1 ◀ 10cm/4" ▶
Fig.2 ◀ 14cm/5½" ▶



Gosset
Fig.1 17-05928-01
Fig.2 17-05928-02



Gosset
17-05932-00

Retractors Only
17-05932-01

Central Blade
17-05932-02
56X60mm



Hertzler
17-05936-00



Frazier
17-05940-00

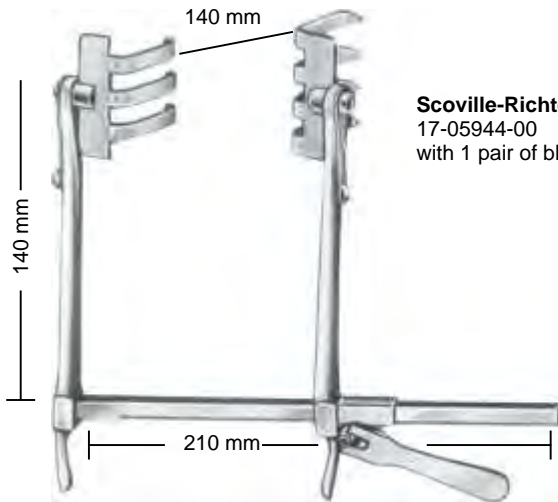

Scoville-Richter
17-05944-00
with 1 pair of blades 17-05944-01

the blades are available by pairs



17-05944-01
60x50 mm

17-05944-02
48x50 mm

17-05944-03
28x40 mm

17-05944-04
38x62 mm

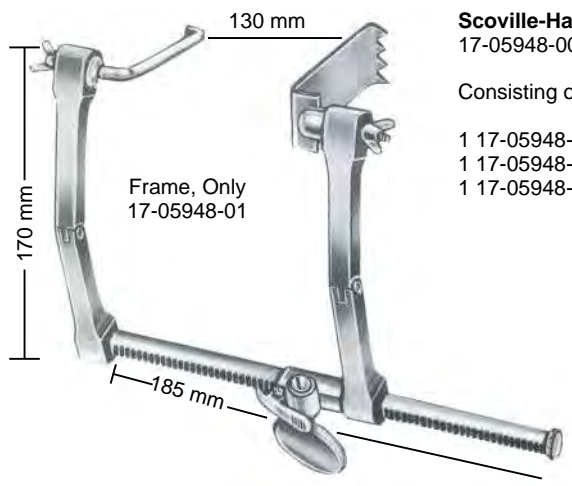

Scoville-Haverfield
17-05948-00

- Consisting of:
- 1 17-05948-01
 - 1 17-05948-02
 - 1 17-05948-03

Frame, Only
17-05948-01



Scoville
17-05948-02
51 mm

Scoville
17-05948-03 63x25 mm
17-05948-04 63x51 mm
17-05948-05 67x32 mm
17-05948-06 89x25 mm

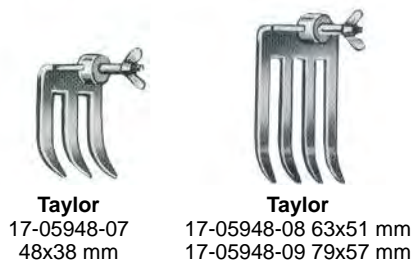

Taylor
17-05948-07
48x38 mm

Taylor
17-05948-08 63x51 mm
17-05948-09 79x57 mm

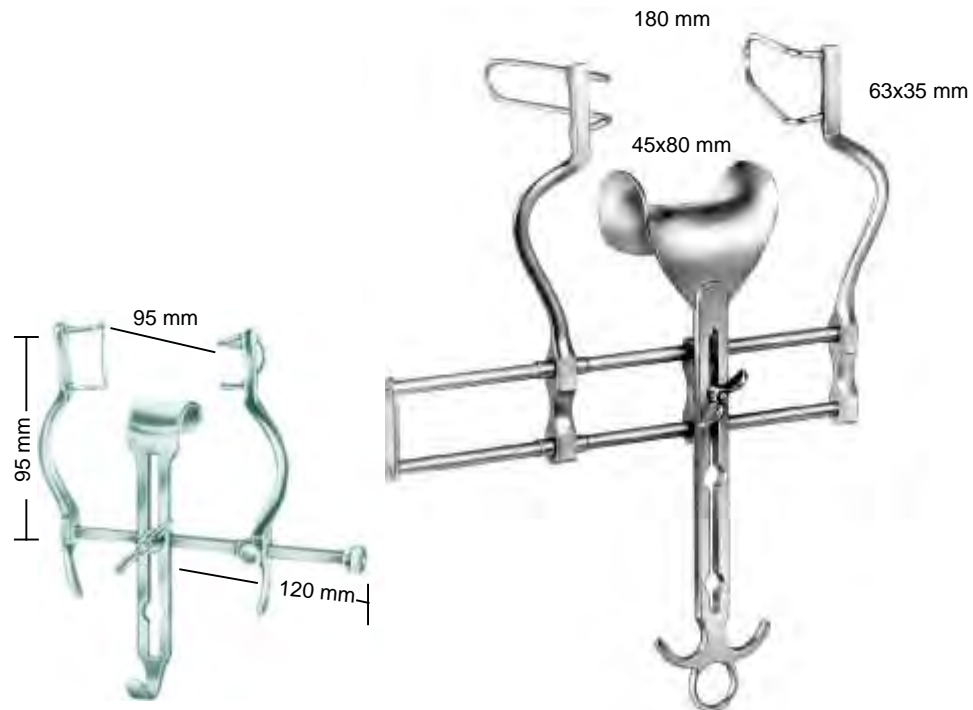

	Baby-Balfour 17-05952-00	Balfour 17-05956-00
Retractor Complete		
Retractor Only	17-05952-01	17-05956-01
Central Blade Only	17-05952-02	17-05956-02



Retractor Complete
17-05960-00

Retractor Only
17-05960-01

Central Blade Only
17-05960-02

Balfour

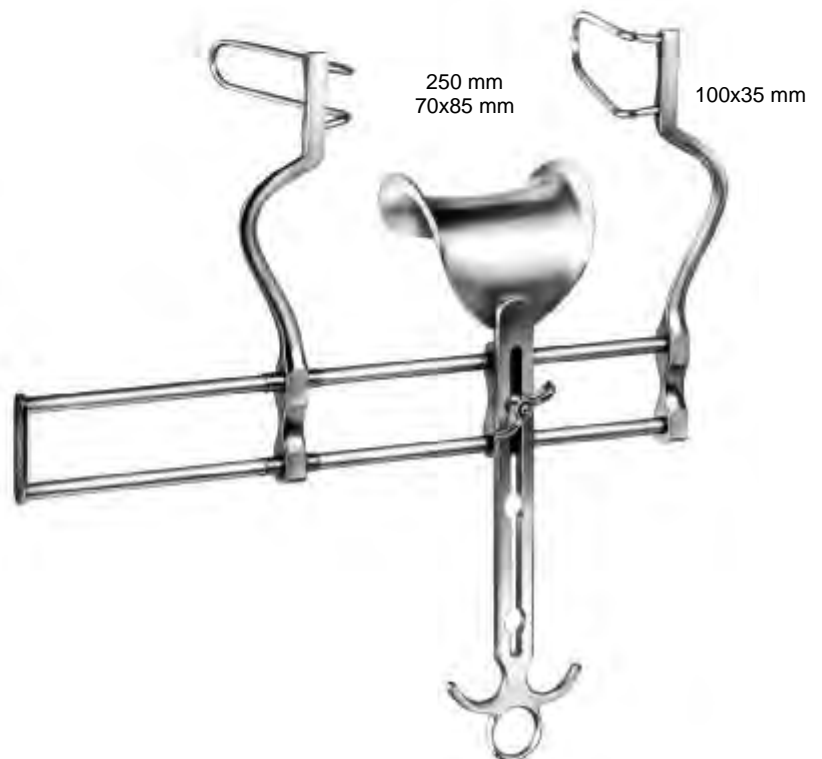

Retractor, Complete
17-05964-00

Retractor Only
17-05964-01

Central Blade Only
17-05964-02

Balfour



Balfour

Retractor, complete
17-05968-00
Retractor, only
17-05968-01
Central blade, only
17-05968-02

Retractor, complete
17-05972-00

Retractor, only
17-05972-01

Central blade, only
17-05972-02
45x68 mm

Lateral blades, only
17-05972-04
60 mm

17-05972-03
68x85 mm

17-05972-05
80 mm



Balfour USA-Modell

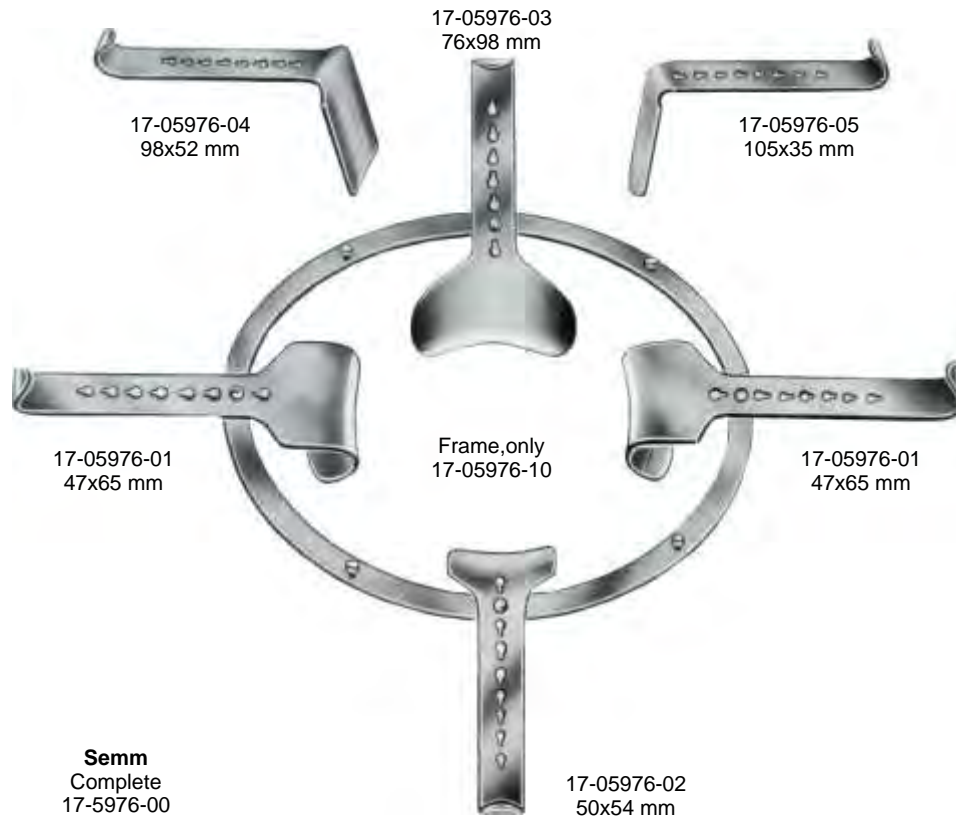

Kirschner
Complete
17-05980-00
1x 17-05980-10
2x 17-05980-01
2x 17-05980-02

- 40x55 mm 17-05980-01
- 50x65 mm 17-05980-02
- 65x80 mm 17-05980-03
- 80x80 mm 17-05980-04
- 90x65 mm 17-05980-05
- 90x90 mm 17-05980-06

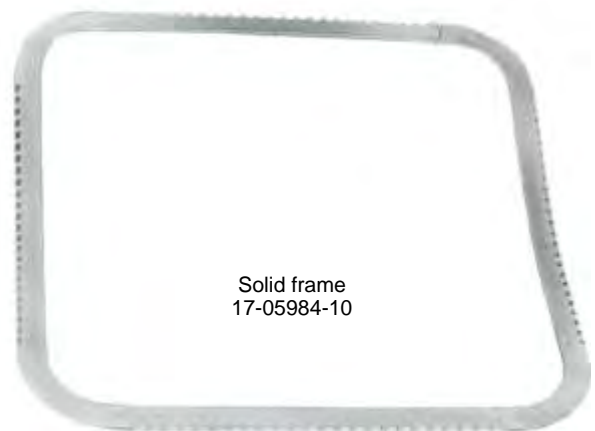

Kirschner
Complete
17-05984-00
1x 17-05984-10
2x 17-05980-01
2x 17-05980-02

General Instruments Abdominal Retractors

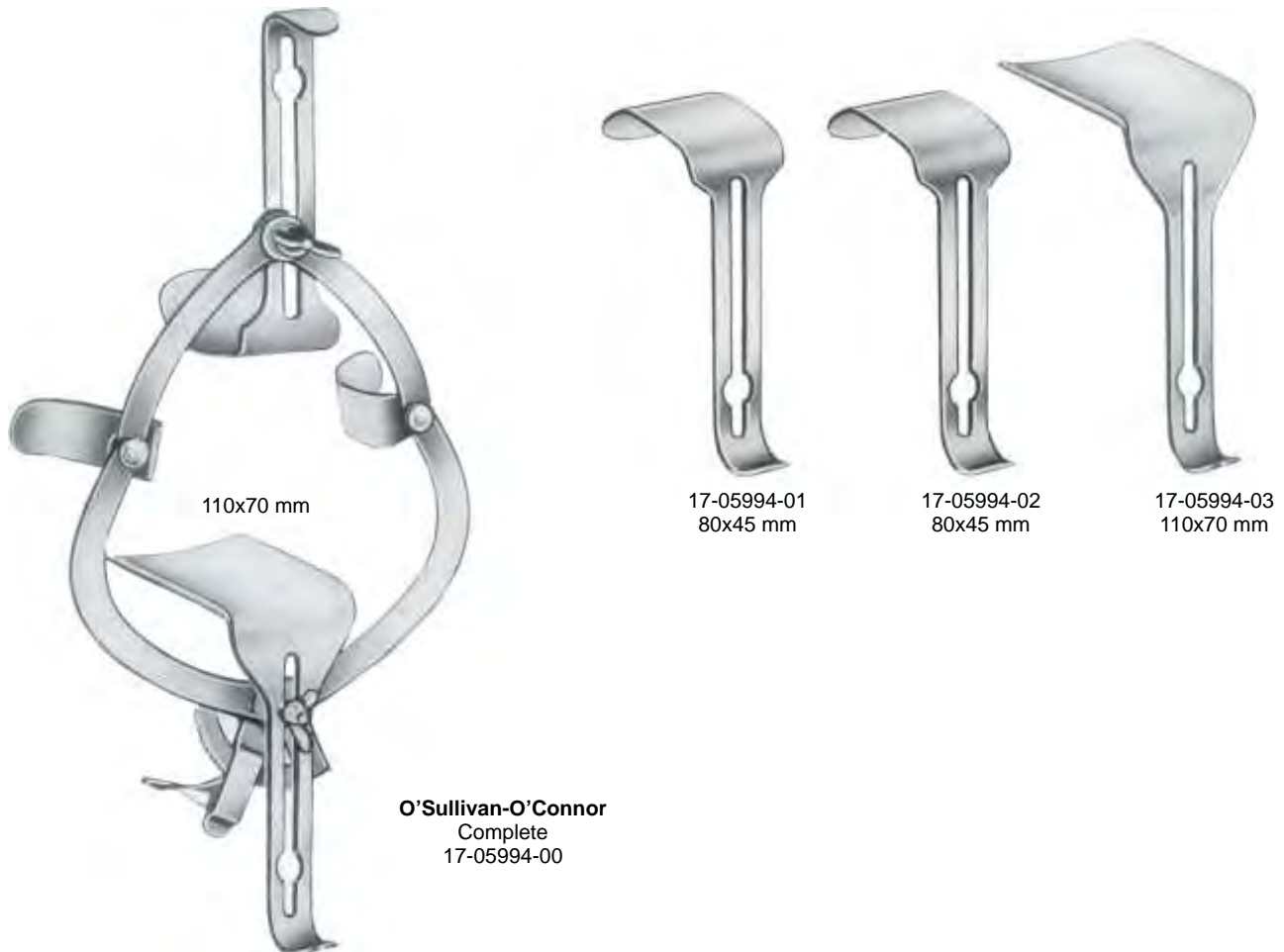
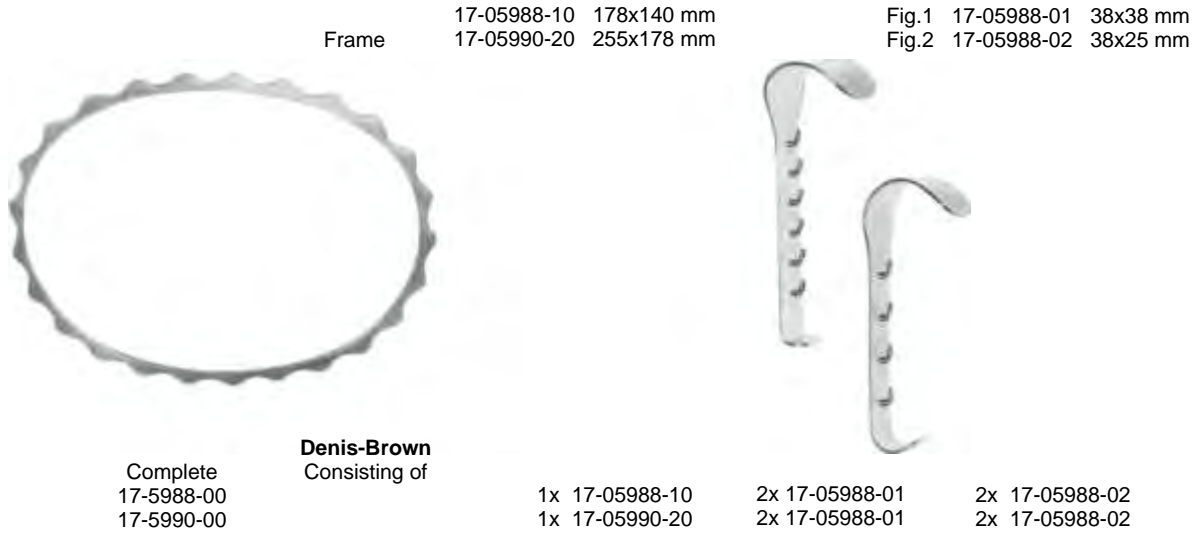

17-05998-01 38x60 mm
17-05998-02 45x80 mm



17-05998-03 50x65 mm
17-05998-04 60x85 mm

Foldable Frame
17-05998-10

Franz

Complete with 4 valves
17-5998-00

With
con
17-05998-10 1x
17-05998-01 2x
17 05998-03 2x

Complete with 8 valves
17-5999-00

With
con
17-05998-10 1x
17-05998-01 2x
17 05998-02 2x
17-05998-03 2x
17-05998-04 2x



17-06002-01 48x90 mm
17-06002-02 48x105 mm
17-06002-03 48x120 mm
17-06002-04 48x135 mm

Doyen
28cm/11"

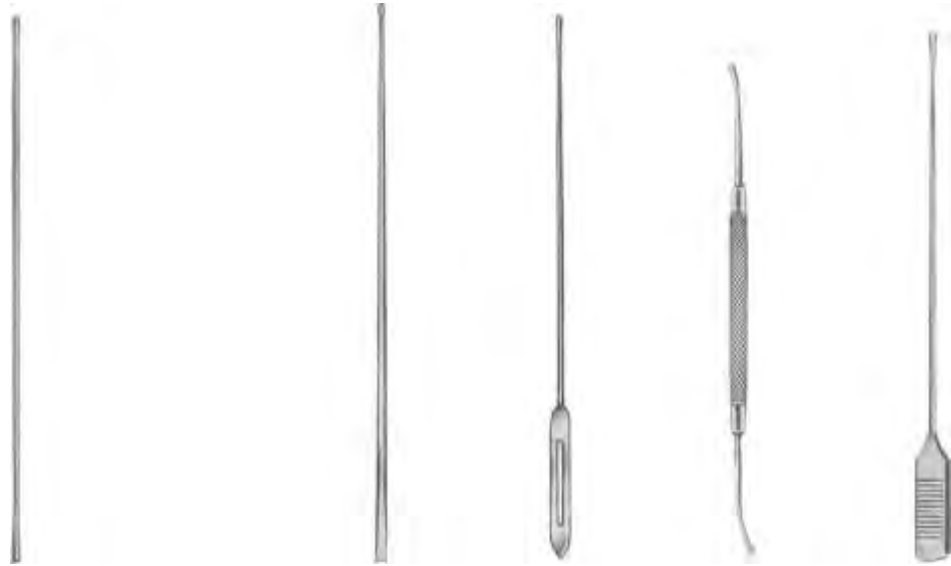

cm	In	1.0 mmØ	1.5 mmØ	2.0 mmØ	2.0 mmØ	Watson-Cheyne	Fish
11.5	4 1/2"	18-06004-11	18-06006-11	18-06008-11		18-06012-11	
13	5"	18-06004-13	18-06006-13	18-06008-13		18-06012-13	18-06016-13
14.5	5 3/4"	18-06004-14	18-06006-14	18-06008-14	18-06010-14	18-06012-14	18-06020-14
16	6 1/4"	18-06004-16	18-06006-16	18-06008-16	18-06010-16	18-06012-16	
18	7"	18-06004-18	18-06006-18	18-06008-18		18-06012-18	18-06016-18 18-06020-18
20	8"	18-06004-20	18-06006-20	18-06008-20		18-06012-20	
25	10"	18-06004-25	18-06006-25	18-06008-25			



cm	In	Nelaton			Stacke 1.0 mm Ø	Brodie
11.5	4 1/4"	18-06024-11			18-06036-10	
13	5"	18-06024-13		18-06028-13		18-06032-13
14.5	5 3/4"	18-06024-14	18-06025-14	18-06028-14		18-06032-14
16	6 1/4"	18-06024-16		18-06028-16		18-06032-16
18	7"	18-06024-18		18-06028-18	18-06033-16	18-06040-16
20	8"	18-06024-20				18-06032-20

Of tin



18-06044-25 25 cm/10"
18-06044-30 30 cm/12"
18-06044-40 40 cm/15¾"

Plaster spatulas



18-06048-13 13 cm/5"
18-06048-14 14 cm/5½"



Pelteson
18-06052-23
23 cm/9"



Fein
18-06054-28
28 cm/11"



Buie
18-06058-16
16 cm/6¼"

Fistula probes



Lockhart-Mummary
16.5 cm/6½"

Fig. 1
18-6062-01



Fig. 2
18-6062-02



Fig. 3
18-6062-03



Fig. 4
18-6062-04



Pratt
21 cm/8¼"



18-06070-01



18-06070-02



18-06070-03



Universal

cm	in	1.2 mm Ø	1.5 mm Ø	1.7 mm Ø
12.5	5"	18-06074-12		
16	6¼"	18-06074-16		
18	7"	18-06074-18	18-06075-18	18-06076-18



Uckermann
18-06078-16
16 cm/6¼"



Jobson-Horne
18-06080-13 13 cm/5"
18-06080-18 18 cm/7"



Round Triangular

**Farrell
(Farrell-Lathbury)**

cm	in	●	▲
12	4¾"		
14	5½"	0.9 mm Ø	18-06084-14 18-06086-14
16	6¼"	1.1 mm Ø	18-06084-16 18-06086-16
18	7"		



Round Triangular

●	●	▲
1.2 mm Ø	1.5 mm Ø	1.5 mm Ø
18-06090-12	18-06092-12	18-06094-12
18-06090-14	18-06092-14	18-06094-14
18-06090-16	18-06092-16	18-06094-16
18-06090-18	18-06092-18	18-06094-18

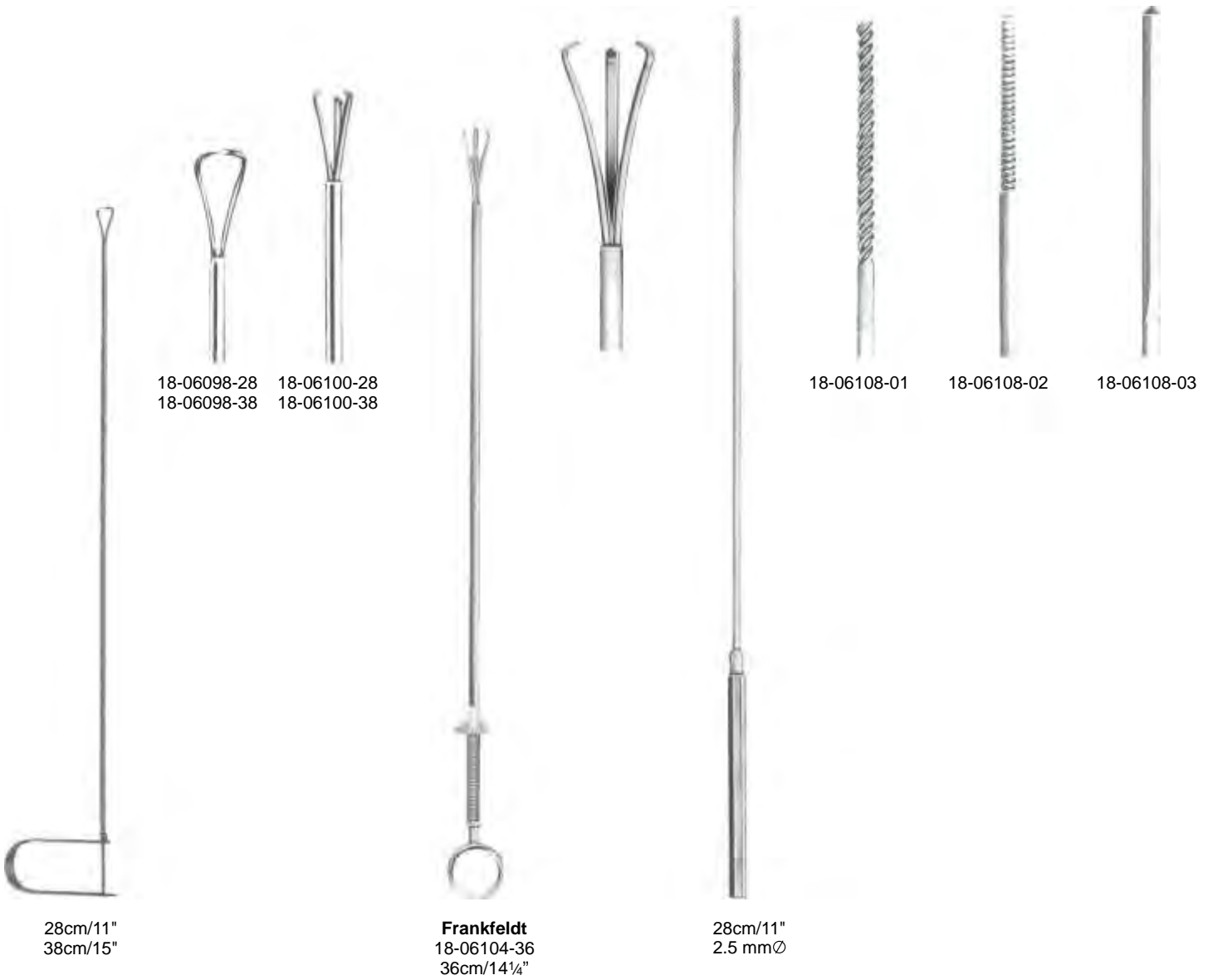

General Instruments Varicose Vein Probe Set and Vein Strippers



Sterilizable

Nabatoff
18-06112-00
135x100x25 mm

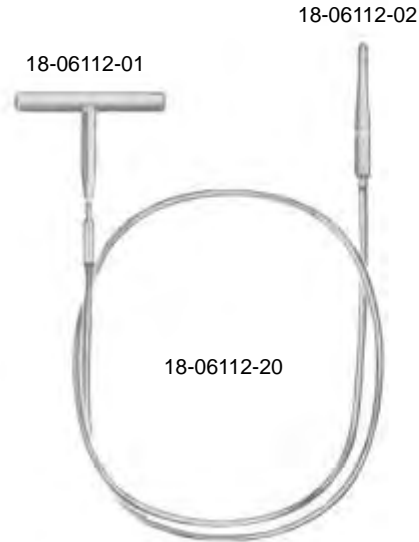

18-06112-01

18-06112-02

18-06112-20



18-06112-03
3 mm Ø

18-06112-06
6 mm Ø

18-06112-09
9 mm Ø

18-06112-12
12 mm Ø

18-06112-15
15 mm Ø

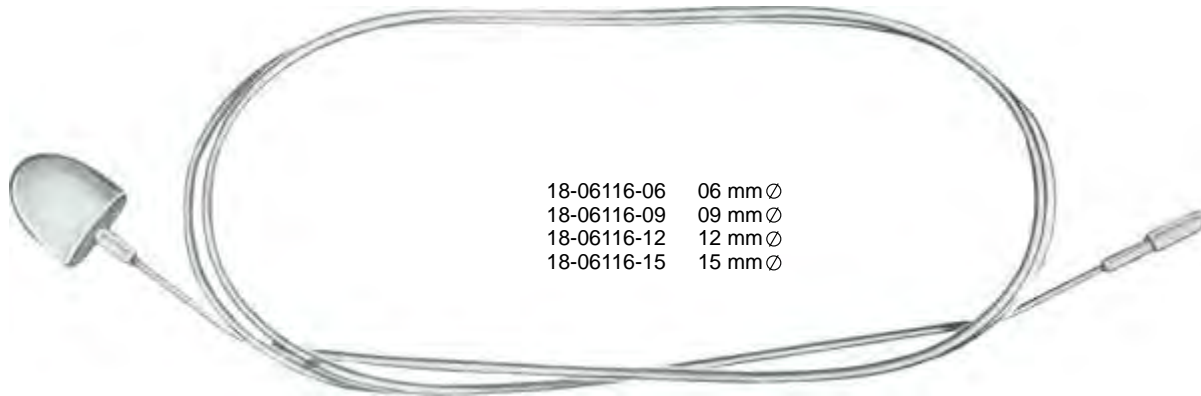

18-06116-06 06 mm Ø
18-06116-09 09 mm Ø
18-06116-12 12 mm Ø
18-06116-15 15 mm Ø

Myers

Strippers



Probes for Varicose Veins

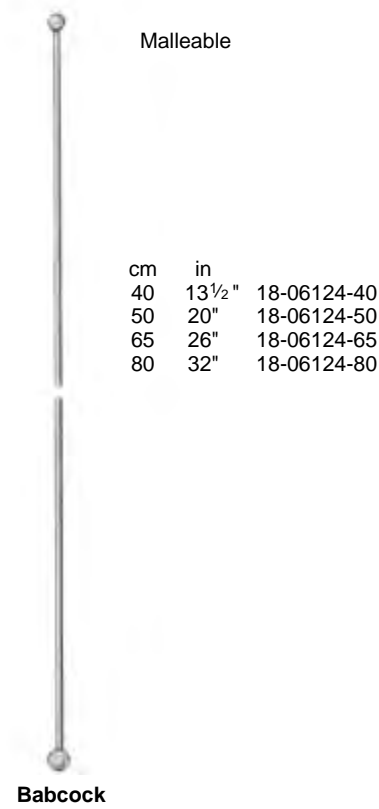

Vessel Irrigating Cannulas

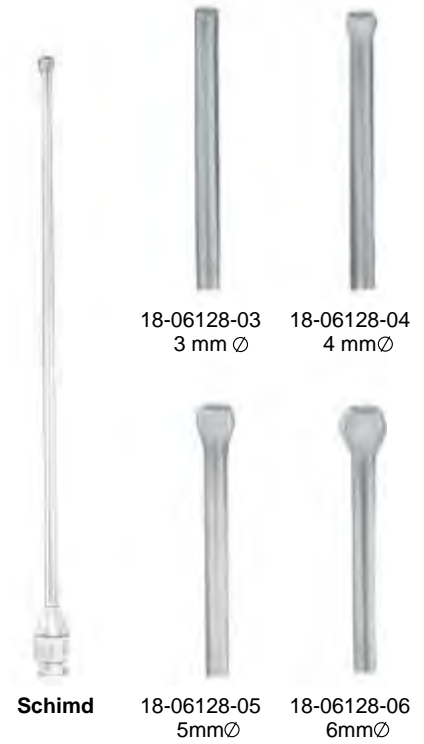

Spatulas

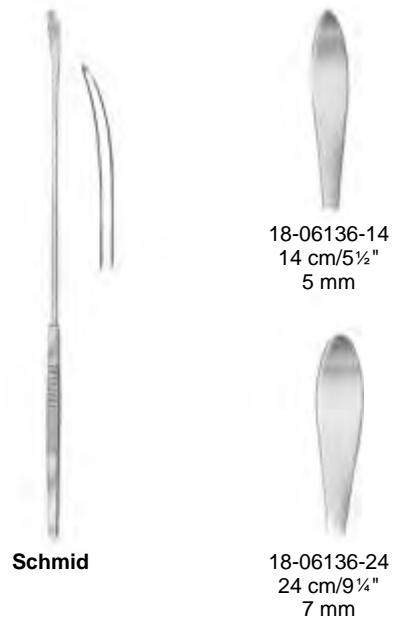
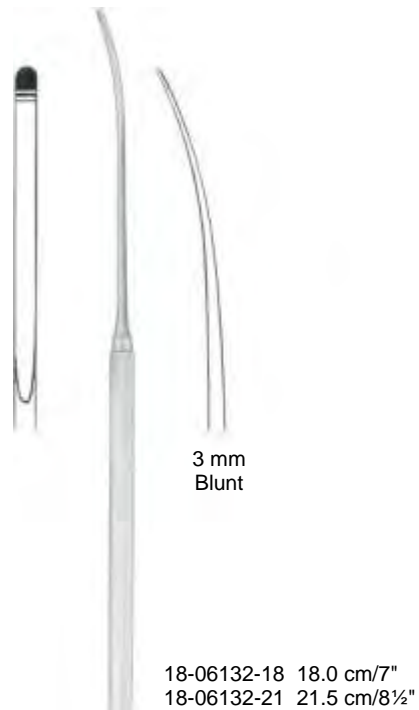

Suture Instruments Micro Needle Holders



Castroviejo
14cm/5 1/2"

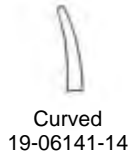

Castroviejo

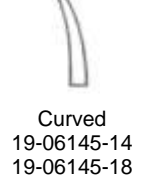
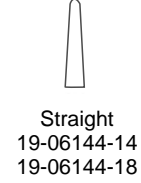

Castroviejo
9cm/3 1/2"



Castroviejo
14cm/5 1/2"



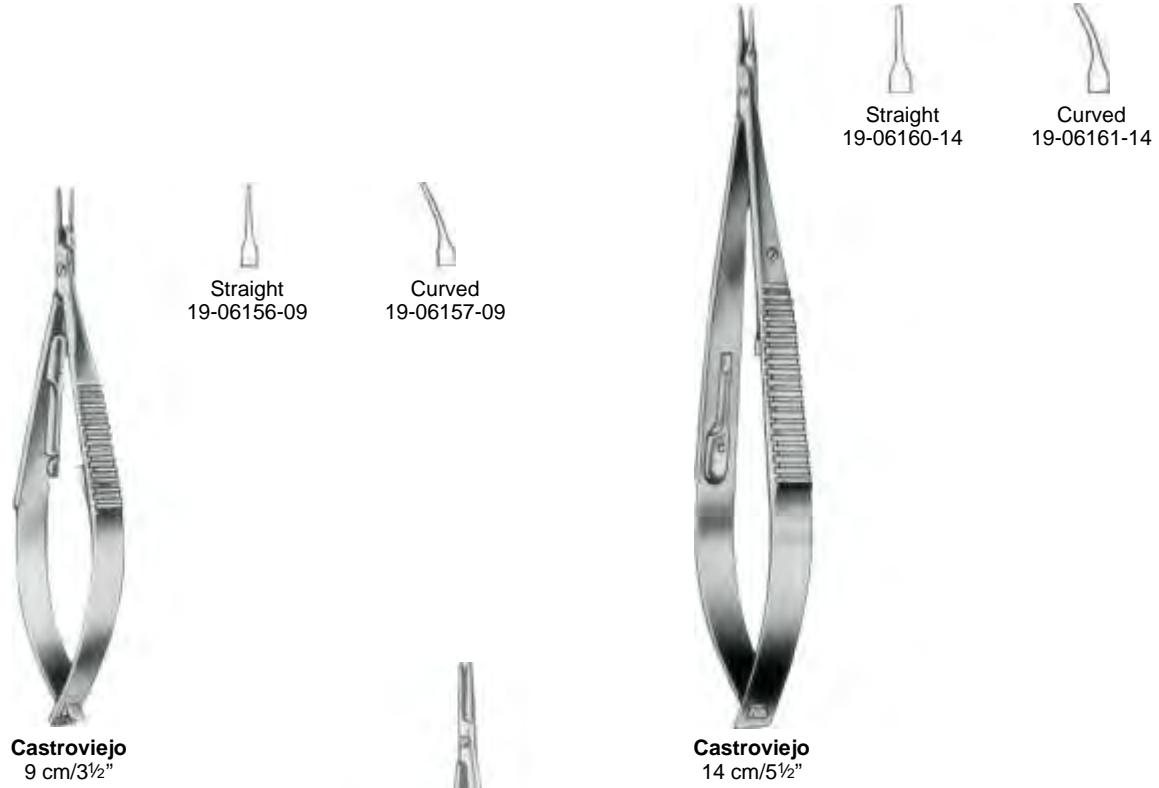

cm	in	Without ratchet	With ratchet
18	7"	19-06168-18	19-06170-18
21	8¼"	19-06168-21	19-06170-21



Yasargil



Straight

19-06174-20 20.0 cm/8"
19-06174-22 22.5 cm/9"



Curved

19-06175-16 16.5 cm/6½"
19-06175-20 20.0 cm/9"
19-06175-22 22.5 cm/9"
19-06175-24 24.5 cm/9¾"



Straight

19-06178-16 16.0 cm/6¼"
19-06178-18 18.5 cm/7¼"



Curved

19-06179-16 16.0 cm/6¼"
19-06179-18 18.5 cm/7¼"



Straight
19-06182-15
15 cm/6"



Curved
19-06183-15
15 cm/6"



Straight
19-06186-18
18 cm/7"



Curved
19-06187-18
18 cm/7"



Straight
19-06190-18
18 cm/7"

Straight



19-06194-18
19-06194-22

Curved



19-06195-18
19-06195-22

Yasargil
18.0 cm/7"
22.5 cm/8¾"



Straight
19-06198-15
15 cm/6"



Curved
19-06199-15
15 cm/6"



Straight
19-06206-15
15 cm/6"



Curved
19-06207-15
15 cm/6"



Straight
19-06210-18
18.5 cm/7 1/4"



Curved
19-06211-18
18.5 cm/7 1/4"



Straight
19-06214-18
18.5 cm/7 1/4"



Curved
19-06215-18
18.5 cm/7 1/4"



Straight
19-06218-23

Curved
19-06219-23

23 cm/9"

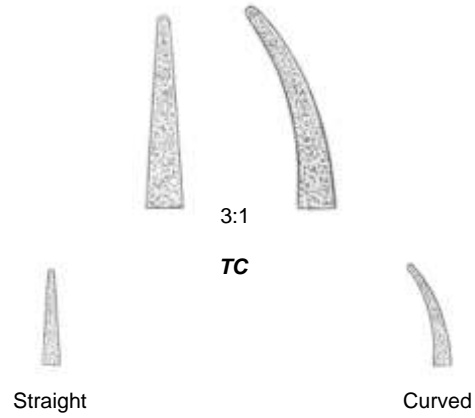

19-06222-18 18 cm/7"
19-06222-21 21 cm/8¼"
19-06222-23 23 cm/9¼"

With ratchet

19-06224-18 18 cm/7"
19-06224-21 21 cm/8 "
19-06224-23 23 cm/9 "

19-06223-18 18 cm/7"
19-06223-21 21 cm/8¼"
19-06223-23 23 cm/9¼"

Without ratchet

19-06225-18 18 cm/7"
19-06225-21 21 cm/8 "
19-06225-23 23 cm/9 "

The new modified structure of a Mouth aires the possibility of the smooth , slide surface of the suture material.
The "careful" Needleholder does not cause notches on the surface of the needles. The needle would not loose her gliding ability.



Straight
19-06226-12
12 cm/4¾"

Curved
19-06227-12
12 cm/4¾"

Angled
19-06229-12
12 cm/4¾"

Straight
19-06232-12
12 cm/4¾"

Curved
19-06233-12
12 cm/4¾"

Angled
19-06235-12
12 cm/4¾"



Arruga
14 cm/5½"

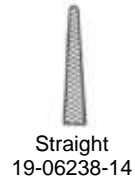

Straight
19-06238-14

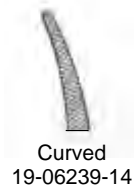

Curved
19-06239-14



Stevens
19-06242-13 13 cm/5"
19-06242-15 15 cm/6"



Kalt
19-06246-14
14 cm/5½"



Castroviejo-Kalt
19-06248-13
13.5 cm/5¼"



Kalt-Arruga
19-06250-14
14 cm/5½"

Suture Instruments Micro Needle Holders



Castroviejo
12cm/4 $\frac{3}{4}$ "



Straight
19-06254-12



Curved
19-06255-12



Castroviejo
12cm/4 $\frac{3}{4}$ "



Straight
19-06258-12



Curved
19-06259-12



Castroviejo
19-06262-13
13cm/5"



Boynton
19-06266-12
12cm/4 $\frac{3}{4}$ "



Arruga
16cm/6 $\frac{1}{4}$ "



Straight
19-06270-16



Curved
19-06271-16



Castroviejo

14cm/5½"
18cm/7"
21cm/8¼"

TC



19-06274-14
19-06274-18
19-06274-21

Smooth



19-06278-14
19-06278-18
19-06278-21



14cm/5½"
18cm/7"
21cm/8¼"

19-06275-14
19-06275-18
19-06275-21



19-06279-14
19-06279-18
19-06279-21



Kalt
14cm/5½"



19-06282-14



19-06284-14



Barraquer
19-06288-14
14cm/5½"



Castroviejo
19-06292-13
13cm/5"



19-06296-18



19-06298-18

Smooth



Hepp-Schiedel
18cm/7"

Suture Instruments Micro Needle Holders with Tungsten Carbide Inserts

TC



Arruga
14cm/5½"

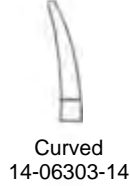

Jacobson
19-06306-18 18cm/7"
19-06306-20 20cm/8"
19-06306-23 23cm/8¾"



Diethrich

Straight		Curved
19-06310-16	16cm/6¼"	19-06311-16
19-06310-18	18cm/7"	19-06311-18
19-06310-20	20cm/8"	19-06311-20
19-06310-23	23cm/9"	19-06311-23
19-06310-25	25cm/10"	19-06311-25



19-06314-13



19-06315-13
Smooth



19-06318-13
Smooth



Derf
19-06322-12
12cm/4¾"



Derf
19-06324-12
12.5cm/5"

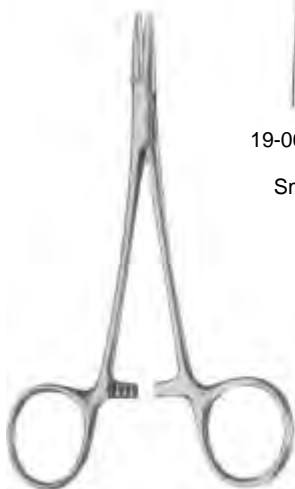

Halsey
13cm/5"



Webster
13cm/5"



Collier
19-06326-12
12.5cm/5"



Hegar-Baumgartner
19-06330-14
14cm/5½"



Brown
19-06334-13 13cm/5"
19-06334-18 18cm/7"



New Orleans
19-06338-18
18cm/7"

Suture Instruments Needle Holders



Mayo-Hegar

13cm/5"	19-06342-13	
14cm/5½"	19-06342-14	
16cm/6¼"	19-06342-16	19-06343-16
18cm/7"	19-06342-18	19-06343-18
20cm/8"	19-06342-20	19-06343-20
24cm/9½"	19-06342-24	19-06343-24
26cm/10¼"	19-06342-26	19-06343-26
30cm/12"	19-06342-30	19-06343-30



Heaney
19-06347-21
21cm/8¼"



Delicate Pattern



Mayo-Hegar
19-06350-16 16cm/6¼"
19-06350-18 18cm/7"
19-06350-20 20cm/8"



Heavy Pattern



Hegar
19-6354-16 16cm/6¼"
19-6354-18 18cm/7"
19-6354-20 20cm/8"





M.G.H.
(Mass.-General-Hospital)
19-06358-17
17 cm/6¾"



Sarot
19-06362-18 18.5 cm/7¼"
19-06362-26 26.0 cm/10¼"



Finocchietto
19-06365-27
27 cm/10½"



Masson
19-06368-27
27 cm/10½"



Jameson
19-06372-23
23.5 cm/9¼"



Wangensteen
19-06376-27
27 cm/10½"



Crile-Wood
19-06380-15
15 cm/6"



Crile-Murray
19-06384-15
15 cm/6"



Adson
19-06388-18
18 cm/7"



Ermold
19-06392-17 17 cm/6¾"
19-06392-20 20 cm/8"

Needle holders with scissors



Baby-Olsen-Hegar
11.5 cm/4½"



Smooth
19-06396-11



Olsen-Hegar
19-06398-14 14 cm/5½"
19-06398-18 18 cm/7"



Olsen-Hegar
19-06400-17
17 cm/6¾"



Olsen-Hegar
19-06404-14
14 cm/5½"



Gillies
19-06406-16
16 cm/6¼"



Gillies Slim
19-06408-14
14 cm/5½"



Crile
19-06412-15
15 cm/6"



Axhausen
19-06416-18
18.5 cm/7¼"



Lichtenberg
19-06420-20
20 cm/8"



Toennis
19-06424-18
18 cm/7"



Mathieu



19-06428-14
19-06428-17
19-06428-20

14cm/5 1/2"
17cm/6 3/4"
20cm/8"



19-06430-14
19-06430-17
19-06430-20



Mathieu

19-06434-14 14cm/5 1/2"
19-06434-17 17cm/6 3/4"
19-06434-20 20cm/8"

Two rings angled

TC



Neivert
19-06438-13
13 cm/5"



Neivert
19-06440-13
13 cm/5"



Webster
19-06444-13
13 cm/5"

Smooth



Derf
19-06448-12
12.5 cm/5"



New Orleans
19-06452-18
18 cm/7"



Bozemann
19-06456-20 20 cm/8"
19-06452-24 24 cm/9½"
19-06452-26 26 cm/10½"

Suture Instruments Needle Holders with Tungsten Carbide Inserts

TC



Mayo-Hegar

19-06460-16
19-06460-18
19-06460-20
19-06460-24
19-06460-26
19-06460-30



19-06461-20
19-06461-24
19-06461-26

16cm/6¼"
18cm/7"
20cm/8"
24cm/9½"
26cm/10½"
30cm/12"



Hegar-Baumgartner
19-06464-14
14cm/5½"



Mayo-Hegar
19-06470-20 20cm/8"
19-06470-24 24cm/9½"



De Bakey
19-06474-18 18cm/7"
19-06474-20 20cm/8"
19-06474-23 23cm/9"
19-06474-26 26cm/10¼"
19-06474-31 31cm/12¼"



De Bakey-Fine
19-06476-18 18cm/7"
19-06476-20 20cm/8"
19-06476-23 23cm/9"
19-06476-26 26cm/10¼"
19-06476-31 31cm/12¼"



TC



Baby-Crile-Wood
19-06480-15
15cm/6"



Crile-Wood
15cm/6"



Crile-Wood

	cm	in
19-06492-18	18	7"
19-06492-20	20	8"
19-06492-23	23	9"
19-06492-26	26	10¼"
19-06492-31	31	12¼"

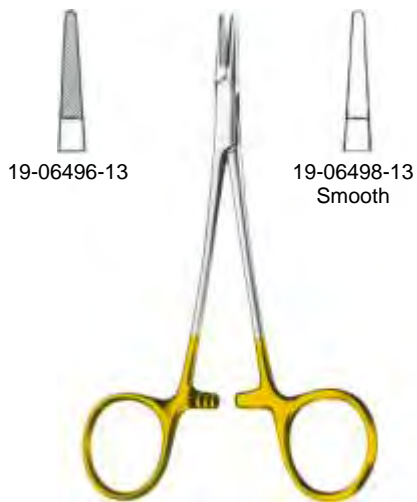

Halsey
13cm/5"



Converse
19-06502-12
12.5cm/5"



Kilner
19-06506-13
13.5cm/5¼"

Suture Instruments Needle Holders with Tungsten Carbide Inserts

TC



Hegar-Vascular

19-06510-14 14cm/5½"
19-06510-18 18cm/7"
19-06510-20 20cm/8"
19-06510-23 23cm/9"



Ryder

19-06514-13
19-06514-15
19-06514-18
19-06514-20
19-06514-23
19-06514-26

Micro-Ryder

19-06516-13 13cm/5"
19-06516-15 15cm/6"
19-06516-18 18cm/7"
19-06516-20 20cm/8"
19-06516-23 23cm/9"
19-06516-26 26cm/10¼"



(Swedish Pattern)

19-06520-15 15cm/6"
19-06520-17 17cm/6¾"
19-06520-20 20cm/8"



Sarot

19-06524-18 18cm/7"
19-06524-26 26cm/10¼"

TC

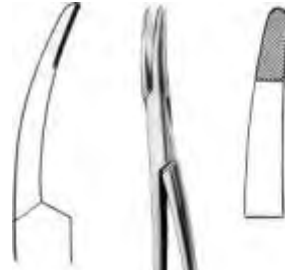

Stratte
19-06528-23
23cm/9"



Masson
19-06532-27
27cm/10½"



Wangenstein
19-06534-27
27cm/10½"



Finocchetto
19-06537-20 20cm/8"
19-06537-27 27cm/10½"

Suture Instruments Needle Holders with Tungsten Carbide Inserts

TC



Mathieu

14cm/5½"	19-06540-14
17cm/6¾"	19-06540-17
20cm/8"	19-06540-20
24cm/9½"	19-06540-24



Mathieu

19-06542-14
19-06542-17
19-06542-20
19-06542-24



Mathieu-Ryder

19-06544-17
19-06544-20



Langenbeck

16cm/6¼"	19-06548-16
18cm/7"	19-06548-18
20cm/8"	19-06548-20



Langenbeck-Ryder

19-06550-18
19-06550-20



Lichtenberg

19-06554-20

TC



Toennis
19-06558-18
18 cm/7"



Mathieu-Kocher
19-06562-14 14 cm/5½"
19-06562-17 17 cm/6¾"
19-06562-20 20 cm/8"



Axhausen
19-06566-18
18.5 cm/7¼"



Zweifel
19-06570-20 20 cm/8"
19-06570-23 23 cm/9"

Suture Instruments Needle Holders with Tungsten Carbide Inserts

TC



19-06574-20 20 cm/8"
19-06574-25 25 cm/10"



Mathieu
19-06578-20 20 cm/8"
19-06578-24 24 cm/9½"



Metzenbaum
19-06582-17 17 cm/6¾"
19-06582-20 20 cm/8"



19-06586-16



19-06587-16



Boynton
19-06590-12
12 cm/4¾"



Hosel
19-06594-20 20 cm/8"
19-06594-25 25 cm/10"

TC



Baby-Olsen-Hegar
19-06598-11
11.5 cm/4½"



Olsen-Hegar
19-06600-14
14 cm/5½"



Olsen-Hegar
19-06602-17
17 cm/6¾"



Olsen-Hegar
19-06604-18
18 cm/7"



Gillies-Slim
19-06607-14
14.5 cm/5½"



Gillies
19-06609-16
16 cm/6¼"

Suture Instruments Ligature Needles

Left



20 cm/8"



19-06612-01



Blunt



19-06612-02



19-06617-01



Sharp



19-06617-02

Deschamps-Standard

Right



20 cm/8"



20 cm/8"



19-06622-01



Blunt



19-06622-02



19-06627-01



Sharp



19-06627-02

Deschamps

20 cm/8"

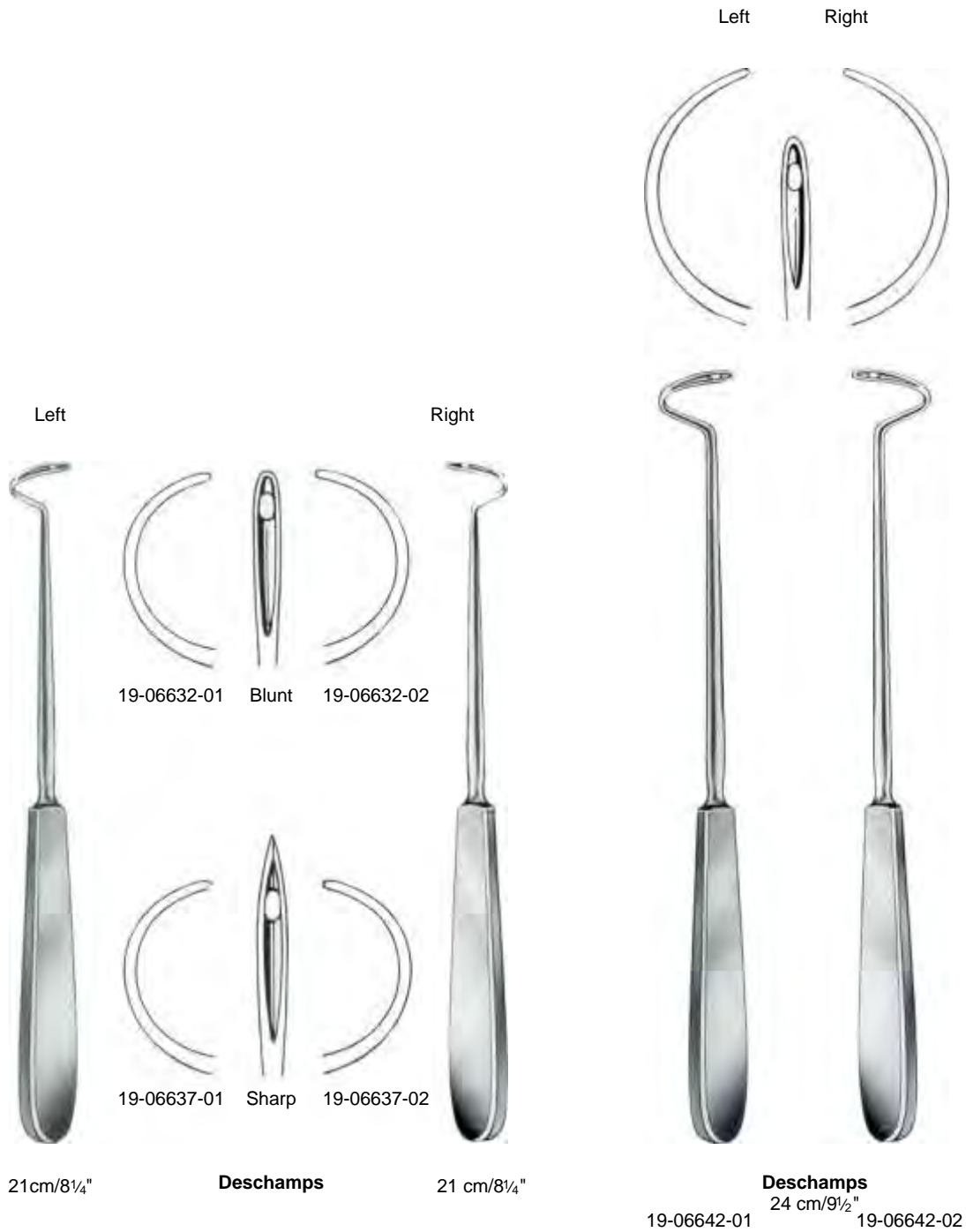

Suture Instruments Ligature Needles

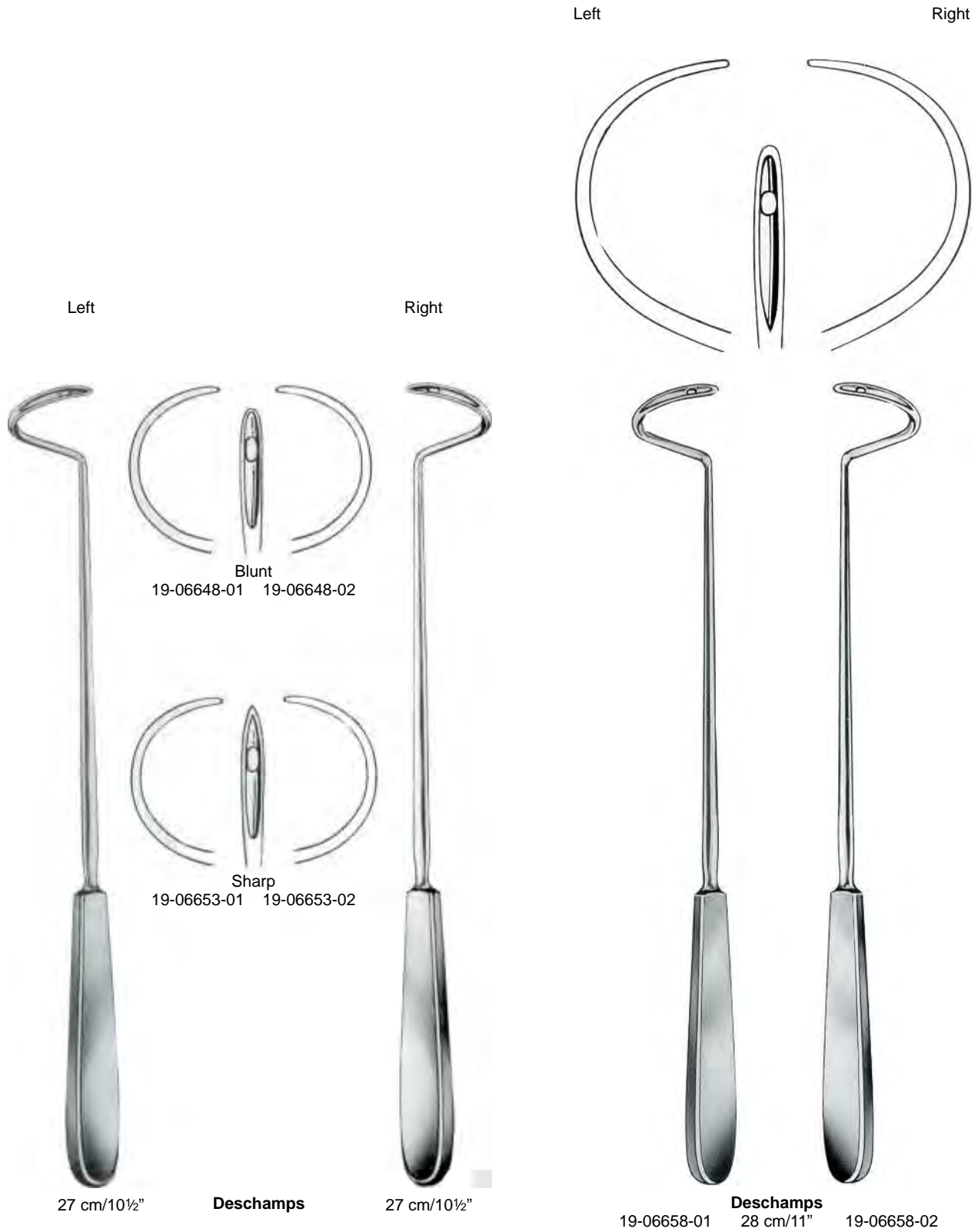



19-06664-01

19-06664-02

19-06664-03

Kocher
19 cm/7½"



Kronecker
19-06672-01 13 cm/5" 19-06672-02



Dupuy-Weiss
19-06677-01 22 cm/8¾" 19-06677-02



Durham
19-06685-01 21 cm/8¼" 19-06685-02



Flexible



Schmieden-Dick
19-06690-32
32 cm/12½"



Schmieden
19-06694-21
21 cm/8¼"



19-06698-20
20 cm/8"

Flexible



Cooper
19-06702-19
19 cm/7½"



With 1 needle

Young
19-06705-21 21 cm/8¼"
19-06707-25 25 cm/10"



19-06705-01



19-06705-02



19-06705-03

Spare needle only



Reverdin
14 cm/5½"



Fig. 1
19-06711-01



Fig. 2
19-06711-02



Fig. 3
19-06711-03



Fig. 4
19-06711-04



Reverdin
19.5 cm/7³/₄"



Fig. 1
19-06715-01



Fig. 2
19-06715-02



Fig. 3
19-06715-03



Fig. 4
19-06715-04



Reverdin
22.5 cm/8³/₄"



Fig. 1
19-06717-01



Fig. 2
19-06717-02



Fig. 3
19-06717-03



Fig. 4
19-06717-04



Brunner
19-06720-25
25 cm/10"



Payr
19-06724-22
22 cm/8¾"



Payr
19-06726-22
22 cm/8¾"



Brunner
19-06730-24
24.5 cm/9¾"

Suture Instruments Ligature Needles and Ligature Conductors

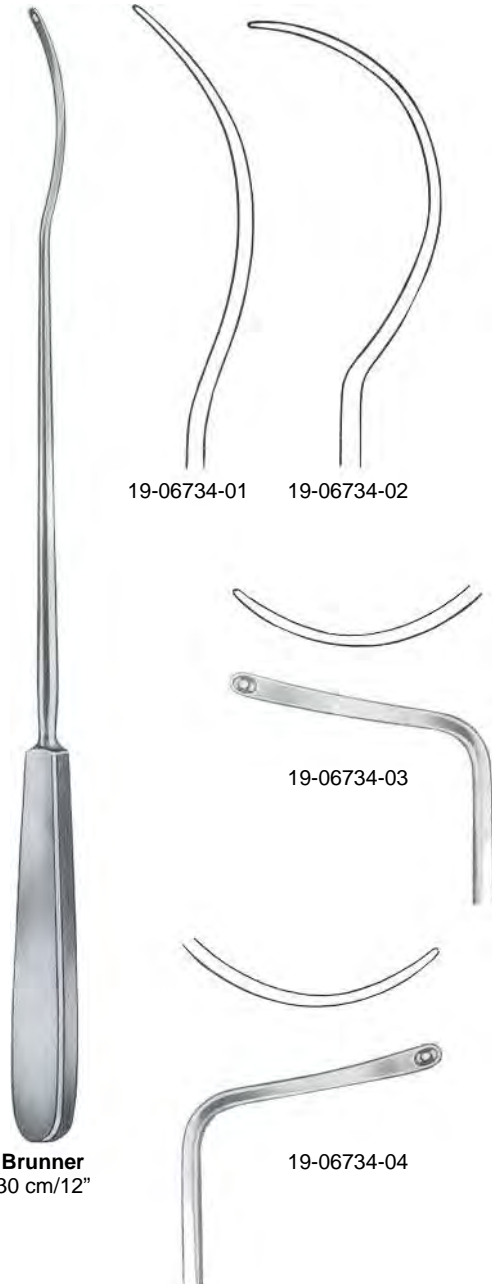



Kirschner
19-06742-25
25.5 cm/10"



19-06746-28
28 cm/11"



Brunner-Ferrozell
19-06750-18 18 cm/7"
19-06750-27 27 cm/10½"



Schmieden-Payr
19-06754-19
19 cm/7½"



Schmieden
19-06756-19
19 cm/7½"

Suture Instruments Ligature Conductors, Knot Tiers and Ligatures



Konig
19-06760-19
19.5 cm/7¾"



Konig
19-06762-19
19.5 cm/7¾"



Konig
19-06764-20
20 cm/8"



Wien
19-06768-23
23.5 cm/9¼"



Bozemann
19-06772-21
21 cm/8¼"



19-06776-23
23 cm/9"



Michel
19-06780-12
12 cm/4¾"



Michel
19-06782-12
12 cm/4¾"



Wachenfeldt
19-06786-12
12 cm/4¾"



Wachenfeldt
19-06788-12
12 cm/4¾"



Wachenfeldt
19-06790-13
13 cm/5"



Wachenfeldt
19-06792-13
13 cm/5"



Michel
19-06796-12
12 cm/4¾"



Michel Modif
19-06798-12
12.5 cm/5"



Collin
19-06802-13
13 cm/5"



Richter-Heath
19-06806-14
14 cm/5½"



Child
19-06810-17
17 cm/6¾"



Child
19-06812-17
17 cm/6¾"

Plaster Instruments Plaster Knives, Plaster Saw and Plaster Spreaders



Hopkins
20-06816-20
20 cm/8"



Esmarch
20-06820-18
18 cm/7"



Reiner
20-06824-18
18.5 cm/7¼"

Plaster Saw



Engel
20-06828-14
14cm/5½"



Henning
20-06832-28
28 cm/11"



Beeson
20-06836-30
30 cm/12"



Haglund-Stille
20-06840-28
28 cm/11"



Mod. USA
20-06844-23
23 cm/9"



Wolff
20-06848-18 18 cm/7"
20-06848-24 24 cm/9½"



Stille
20-06852-24
24 cm/9½"



Stille
20-06856-23 23 cm/9"
20-06856-26 26 cm/10¼"
20-06856-37 37 cm/14½"

Bone Instruments Bone Chisels, Gouges and Osteotomes



mm
02
03
04
05
06
07
08

Partsch
21-06860-02
21-06860-03
21-06860-04
21-06860-05
21-06860-06
21-06860-07
21-06860-08
13.5 cm/5¼"

21-06862-02
21-06862-03
21-06862-04
21-06862-05
21-06862-06
21-06862-07
21-06862-08
17 cm/6¾"

Partsch
21-06866-02
21-06866-03
21-06866-04
21-06866-05
21-06866-06
21-06866-07
21-06866-08
13.5 cm/5¼"

21-06868-04
21-06868-06
21-06868-08
21-06868-10
21-06868-12
21-06868-14
21-06868-16
17cm/6¾"

Width

mm
04
06
08
10
12
14
16

21-06870-04
21-06870-06
21-06870-08
21-06870-10
21-06870-12
21-06870-14
21-06870-16
13.5 cm/5¼"

21-06872-04
21-06872-06
21-06872-08
21-06872-10
21-06872-12
21-06872-14
21-06872-16

21-06874-04
21-06874-06
21-06874-08
21-06874-10
21-06874-12
21-06874-14
21-06874-16



21-06886-03
3mm
21-06886-05
5mm
21-06886-07
7mm
21-06886-09
9mm

mm
06
12
18

21-06878-06
21-06878-12
21-06878-18

Mod. USA
21-06880-06
21-06880-12
21-06880-18
16 cm/6¼"

21-06882-06
21-06882-12
21-06882-18

16 cm/6¼"

Passow
12 cm/4¾"

21-06890-02
2.5mm
21-06890-03
3.5mm



Lexer
27.5 cm/10¾"

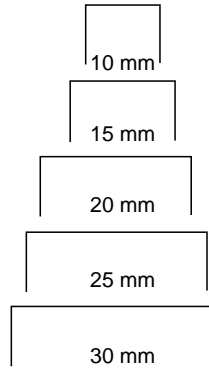

21-06893-10
21-06893-15
21-06893-20
21-06893-25
21-06893-30



21-06895-10
21-06895-15
21-06895-20
21-06895-25
21-06895-30



Cloward
24 cm/9½"

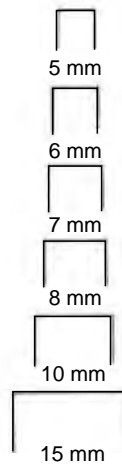

21-06898-05
21-06898-06
21-06898-07
21-06898-08
21-06898-10
21-06898-15



21-06900-05
21-06900-06
21-06900-07
21-06900-08
21-06900-10
21-06900-15

Bone Instruments Bone Chisels and Gouges Osteotomes



Alexander
18 cm/7"

	mm	
21-06904-04	04	21-06906-04
21-06904-06	06	21-06906-06
21-06904-08	08	21-06906-08
21-06904-10	10	21-06906-10
21-06904-12	12	21-06906-12
21-06904-14	14	21-06906-14

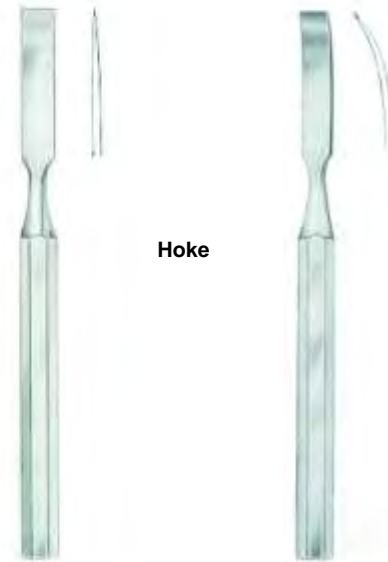

Hoke

14 cm/5½"

	mm	
21-06910-02	2	21-06911-02
21-06910-03	3	21-06911-03
21-06910-04	4	21-06911-04
21-06910-05	5	21-06911-05
21-06910-06	6	21-06911-06
21-06910-07	7	21-06911-07
21-06910-08	8	21-06911-08



Smith-Petersen
20 cm/8"

mm				
06	21-06914-06	21-06915-06	21-06918-06	21-06919-06
09	21-06914-09	21-06915-09	21-06918-09	21-06919-09
13	21-06914-13	21-06915-13		
14			21-06918-14	21-06919-14
16	21-06914-16	21-06915-16	21-06918-16	21-06919-16
19	21-06914-19	21-06915-19	21-06918-19	21-06919-19
25	21-06914-25	21-06915-25	21-06918-25	21-06919-25
32	21-06914-32	21-06915-32	21-06918-32	21-06919-32



Lambotte

	mm	
21-06922-04	04	24 cm/9½"
21-06922-06	06	
21-06922-08	08	
21-06922-10	10	
21-06922-13	13	
21-06922-16	16	
21-06922-18	18	
21-06922-20	20	
21-06922-25	25	
21-06922-30	30	
21-06922-38	38	
21-06922-44	44	
21-06922-50	50	

Curved



21-06923-04		23 cm/9"
21-06923-06		
21-06923-08		
21-06923-10		
21-06923-13		
21-06923-16		
21-06923-18		
21-06923-20		
21-06923-25		
21-06923-30		
21-06923-38		
21-06923-44		
21-06923-50		



Mini-Lambotte

	mm	
21-06926-02	02	12.5 cm/5"
21-06926-03	03	
21-06926-04	04	
21-06926-06	06	
21-06926-08	08	
21-06926-10	10	
21-06926-12	12	
21-06926-15	15	
21-06927-02		17 cm/6¾"
21-06927-03		
21-06927-04		
21-06927-06		
21-06927-08		
21-06927-10		
21-06927-12		
21-06927-15		



Mini-Lexer

	mm	
21-06930-04	04	18 cm/7"
21-06930-06	06	
21-06930-08	08	
21-06930-10	10	
21-06930-12	12	
21-06932-04		
21-06932-06		
21-06932-08		
21-06932-10		
21-06932-12		



Lexer

	mm	
21-06936-05	05	22 cm/8¾"
21-06936-07	07	
21-06936-10	10	
21-06936-15	15	
21-06936-20	20	
21-06936-25	25	
21-06936-30	30	
21-06938-05		
21-06938-07		
21-06938-10		
21-06938-15		
21-06938-20		
21-06938-25		
21-06938-30		





Chisel
21-06942-20
24.5 cm/9 3/4"
20 mm



Chisel-Curved
21-06943-20
26.5 cm/10 1/2"
20 mm

Gouge for the
removing of
broken screws



21-06944-22
22 cm/8 3/4"



Zielke
23 cm/9"
5.5 mm
9.0 mm

21-06948-05
21-06948-09

Stille
20 cm/8"

mm
06
08
10
12
15
20
25
30

Width



21-06950-06	21-06952-06	21-06953-06	21-06956-06	21-06957-06
21-06950-08	21-06952-08	21-06953-08	21-06956-08	21-06957-08
21-06950-10	21-06952-10	21-06953-10	21-06956-10	21-06957-10
21-06950-12	21-06952-12	21-06953-12	21-06956-12	21-06957-12
21-06950-15	21-06952-15	21-06953-15	21-06956-15	21-06957-15
21-06950-20	21-06952-20	21-06953-20	21-06956-20	21-06957-20
21-06950-25	21-06952-25	21-06953-25	21-06956-25	21-06957-25
21-06950-30	21-06952-30	21-06953-30	21-06956-30	21-06957-30



Hibbs
24 cm/9½"

mm
06
09
13
16
19
25
32

21-06960-06	21-06961-06	21-06964-06	21-06966-06	21-06967-06
21-06960-09	21-06961-09	21-06964-09	21-06966-09	21-06967-09
21-06960-13	21-06961-13	21-06964-13	21-06966-13	21-06967-13
21-06960-16	21-06961-16	21-06964-16	21-06966-16	21-06967-16
21-06960-19	21-06961-19	21-06964-19	21-06966-19	21-06967-19
21-06960-25	21-06961-25	21-06964-25	21-06966-25	21-06967-25
21-06960-32	21-06961-32	21-06964-32	21-06966-32	21-06967-32



mm **Lexer**
05 21-06970-05
10 21-06970-10
15 21-06970-15

28 cm/11"



Lexer
21-06972-05
21-06972-10
21-06972-15

25 cm/10"



Lexer
21-06973-05
21-06973-10
21-06973-15

25 cm/10"



21-06976-01



21-06977-02



21-06977-03



Cobb
28 cm/11"

21-06977-04



Volkman
17 cm/6³/₄"

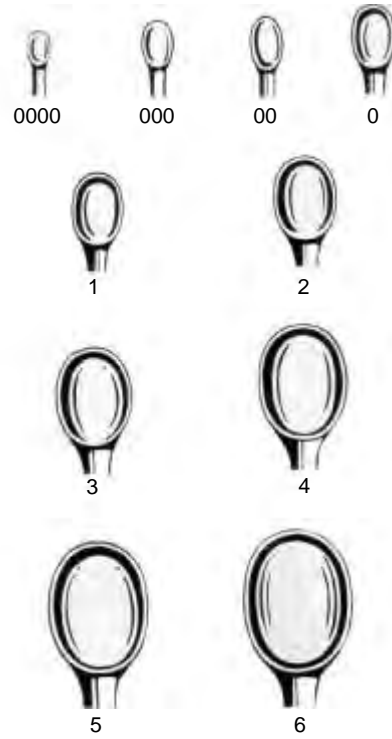

- Fig.
0000 21-06980-40
000 21-06980-30
00 21-06980-20
0 21-06980-10
1 21-06980-01
2 21-06980-02
3 21-06980-03
4 21-06980-04
5 21-06980-05
6 21-06980-06



Volkman
17 cm/6³/₄"

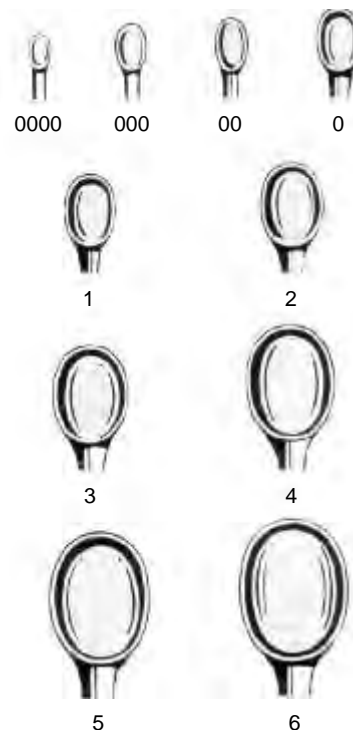

- Fig.
0000 21-06984-40
000 21-06984-30
00 21-06984-20
0 21-06984-10
1 21-06984-01
2 21-06984-02
3 21-06984-03
4 21-06984-04
5 21-06984-05
6 21-06984-06

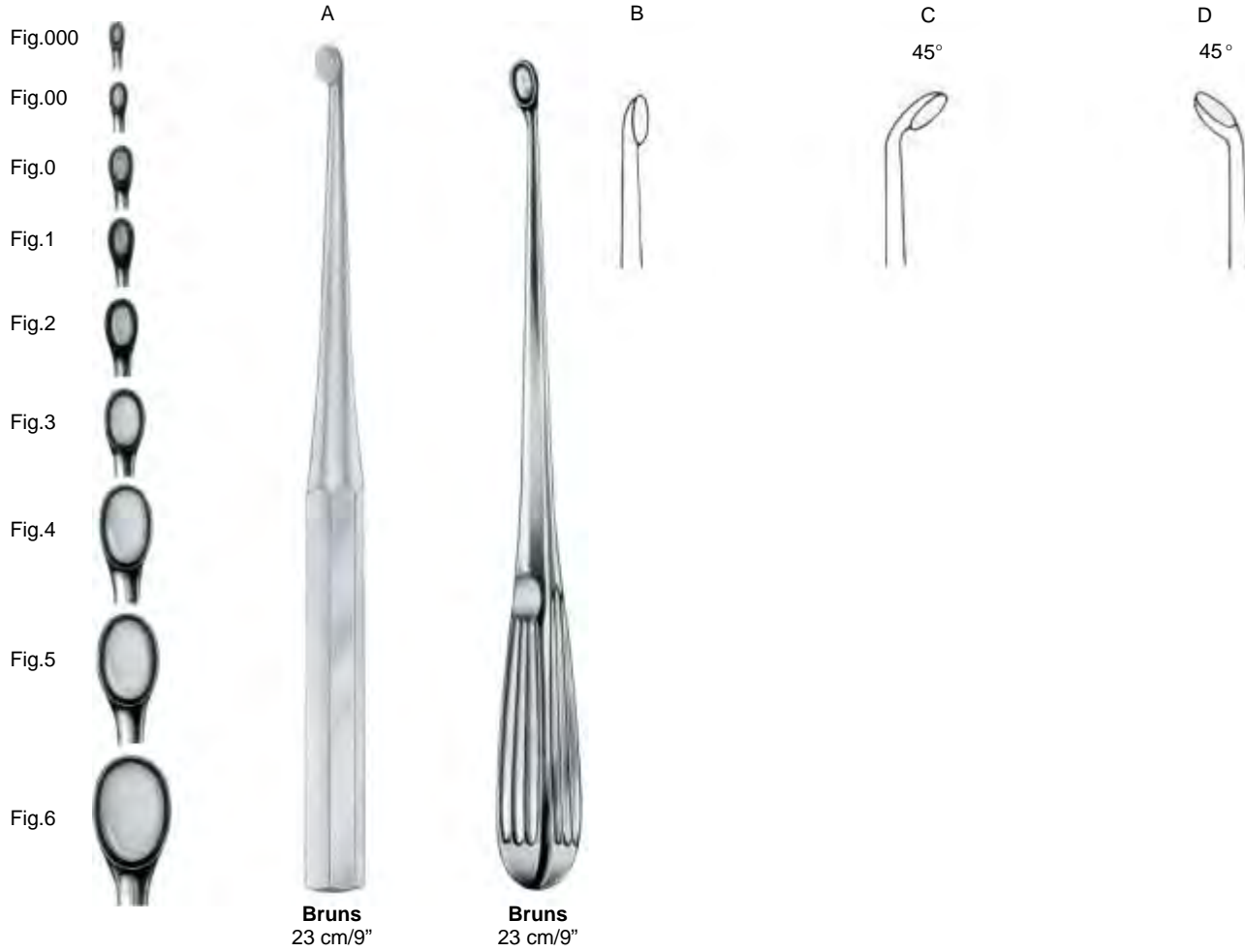
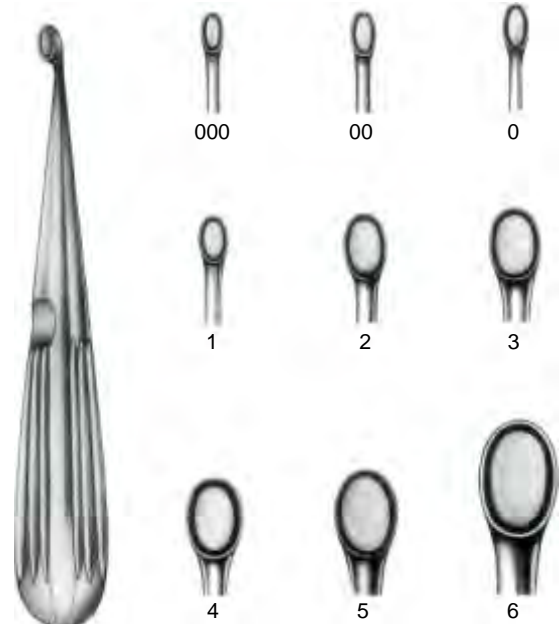

Fig.	A	B	C	D
000	21-06988-30	21-06990-30	21-06991-30	21-06993-30
00	21-06988-20	21-06990-20	21-06991-20	21-06993-20
0	21-06988-10	21-06990-10	21-06991-10	21-06993-10
1	21-06988-01	21-06990-01	21-06991-01	21-06993-01
2	21-06988-02	21-06990-02	21-06991-02	21-06993-02
3	21-06988-03	21-06990-03	21-06991-03	21-06993-03
4	21-06988-04	21-06990-04	21-06991-04	21-06993-04
5	21-06988-05	21-06990-05	21-06991-05	21-06993-05
6	21-06988-06	21-06990-06	21-06991-06	21-06993-06



Bruns
17 cm/6¾"

Bruns	Fig.	Spratt
21-06996-30	000	21-06998-30
21-06996-20	00	21-06998-20
21-06996-10	0	21-06998-10
21-06996-01	1	21-06998-01
21-06996-02	2	21-06998-02
21-06996-03	3	21-06998-03
21-06996-04	4	21-06998-04
21-06996-05	5	21-06998-05
21-06996-06	6	21-06998-06



Spratt
16 cm/6¼"



Swedish pattern

mm	Round	Oval
2	21-07002-02	21-07004-02
3	21-07002-03	21-07004-03
4	21-07002-04	21-07004-04
5	21-07002-05	21-07004-05
6	21-07002-06	21-07004-06
7	21-07002-07	21-07004-07
8	21-07002-08	21-07004-08
10	21-07002-10	21-07004-10
12	21-07002-12	21-07004-12
14	21-07002-14	21-07004-14
	17cm/6¾"	22cm/8½"



Schede
17 cm/6¾"



Fig.	
000	21-07008-30
00	21-07008-20
0	21-07008-10
1	21-07008-01
2	21-07008-02
3	21-07008-03
4	21-07008-04



Williger
17.5 cm/7"



Straight, Oval

21-07012-20
21-07012-10
21-07012-01
21-07012-02

Straight

Fig.	
00	21-07014-20
0	21-07014-10
1	21-07014-01
2	21-07014-02



21-07017-01

Uffenorde
17 cm/6¾"



21-07017-02



Fig. 0
21-07018-10



Fig. 1
21-07018-01



Fig. 2
21-07018-02



Fig. 3
21-07018-03



Volkmann
27 cm/10½"



Fig. 1
21-07020-01



Fig. 2
21-07020-02



Fig. 3
21-07020-03



Simon
24 cm/9½"



Fig. 4
21-07020-04



Fig. 5
21-07020-05



Fig. 6
21-07020-06



Fig. 0000
21-07022-40



Fig. 000
21-07022-30



Fig. 00
21-07022-20



Fig. 0
21-07022-10



Simon
24 cm/9½"



Fig. 00
21-07024-20



Fig. 0
21-07024-10



Fig. 1
21-07024-01

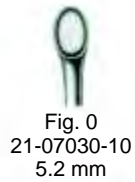
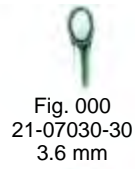

Fig. 2
21-07024-02



Daubenspeck
20 cm/8"

Flexible





	Volkman		Volkman	
Length	Oval/Oval		Oval/Round	
cm	in			
13	5"	21-07038-13		21-07040-13
14	5½"	21-07038-14		
16	6¼"			21-07040-16
17	6¾"	21-07038-17		
20	8"	21-07038-20		21-07040-20



Martini
13.5 cm/5"



Jansen
21-07046-15
15 cm/6"



Jansen
21-07050-16
16 cm/6¼"

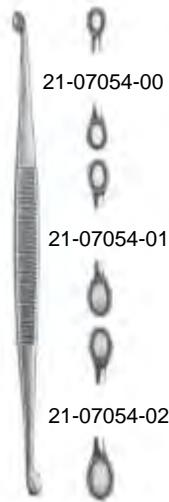

Williger
13.5 cm/5"



Jacobson
21-07058-13
13 cm/5"



Janson
21-07062-15
15 cm/6"



Barth
21-07064-18
18 cm/7"

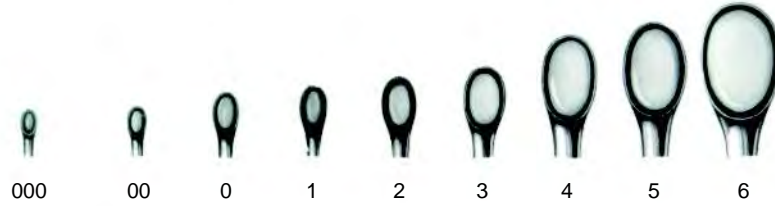

21-07066-21
21 cm/8 1/4"



Epstein



Spinal



Spinal

Fig.			
000	21-07069-30	21-07072-30	21-07074-30
00	21-07069-20	21-07072-20	21-07074-20
0	21-07069-10	21-07072-10	21-07074-10
1	21-07069-01	21-07072-01	21-07074-01
2	21-07069-02	21-07072-02	21-07074-02
3	21-07069-03	21-07072-03	21-07074-03
4	21-07069-04	21-07072-04	21-07074-04
5	21-07069-05	21-07072-05	21-07074-05
6	21-07069-06	21-07072-06	21-07074-06
	20 cm/8"	20 cm/8"	20 cm/8"



Putti
21-07078-30
30 cm/12"



Putti
21-07080-27
27 cm/10½"



21-07084-25
25 cm/10"



21-07088-24
24 cm/9½"



21-07092-22
22 cm/8¾"

Bone Instruments Periosteal Raspatories



Farabeuf
21-07096-15
15 cm/6"



Farabeuf
21-07098-15
15 cm/6"



Farabeuf-Collin
21-07100-15
15.5 cm/6"
11 mm



Farabeuf-Collin
21-07102-15
15.5 cm/6"
11 mm



Farabeuf
21-07104-19
19 cm/7½"
13 mm



Sedillot
21-07108-18
18 cm/7"
18 mm



Sedillot
21-07110-21
21 cm/8¼"
15 mm



Langenbeck
21-07114-19
19 cm/7½"



Langenbeck
21-07116-18
18 cm/7"



Lambotte
21 cm/8¼"

Width

	mm
21-07120-05	05
21-07120-10	10
21-07120-15	15
21-07120-20	20
21-07120-25	25



Schneider
21-07124-17
13 mm
17.5 cm/7"



Schneider-Sauerbruch
21-07126-19
13 mm
19 cm/7½"



Alexander
21-07130-20
20 cm/8"



Jansen
21-07134-16
15 mm
16.5 cm/6½"



Seldin
21-07138-19
19 cm/7½"



Davidson-Alexander
21-07142-29
29 cm/11½"



Williger
21-07146-29
13 cm/5"

Bone Instruments Periosteal Raspatories



König
21-07150-15
15.5 cm/6"
5 mm



Williger
21-07154-16
16 cm/6¼"



Adson
17 cm/6¾"



21-07158-01



21-07158-02



21-07158-03



21-07158-04



21-07162-06 17 cm/6¾"
6 mm



21-07162-08
8 mm



Overholt
21-07166-29
29.5 cm/11½"



Overholt
21-07168-29
29.5 cm/11½"



Overholt
21-07170-28
28.5 cm/11¼"



Hylin
21-07174-03
14.5 cm/5¾"



21-07174-01



21-07174-02



21-07174-03



Matson
21-07178-22
22 cm/8¾"

Bone Instruments Periosteal Respiratories



Semb



21-07182-01 19.5 cm/7½" 12 mm	21-07182-02 19.5 cm/7½" 12 mm	21-07182-03 19.5 cm/7½" 12 mm	21-07182-04 22 cm/8¾" 13 mm	21-07182-05 21.5 cm/8½" 13 mm	21-07182-06 22 cm/8½" 15 mm	21-07182-07 22 cm/8½" 15 mm
-------------------------------------	-------------------------------------	-------------------------------------	-----------------------------------	-------------------------------------	-----------------------------------	-----------------------------------



Doyen
17 cm/6¾"

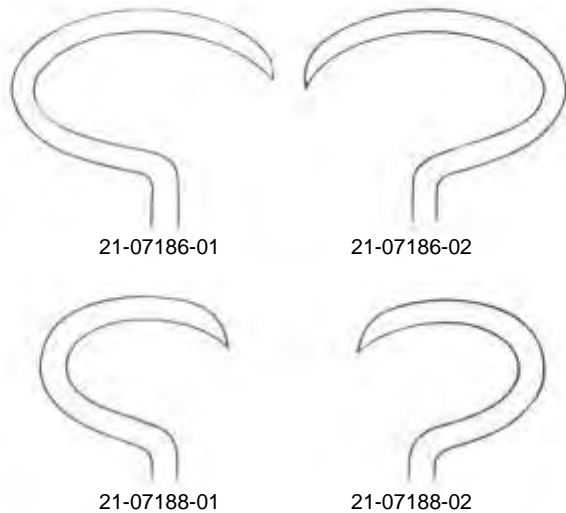

21-07186-01	21-07186-02
21-07188-01	21-07188-02



21-07190-01	Doyen 24 cm/9½"	21-07190-02
-------------	---------------------------	-------------



21-07194-04
4 mm



21-07194-06
6 mm



21-07194-08
8 mm



Cobb
24 cm/9½"



21-07194-10
10 mm



21-07194-13
13 mm



21-07194-19
19 mm



21-07194-25
25 mm



21-07198-01
19 cm/7½"
6 mm



21-07199-02
18.5 cm/7¼"
3 mm



21-07201-03
18.5 cm/7¼"
6 mm



21-07203-04
18.5 cm/7¼"
6 mm

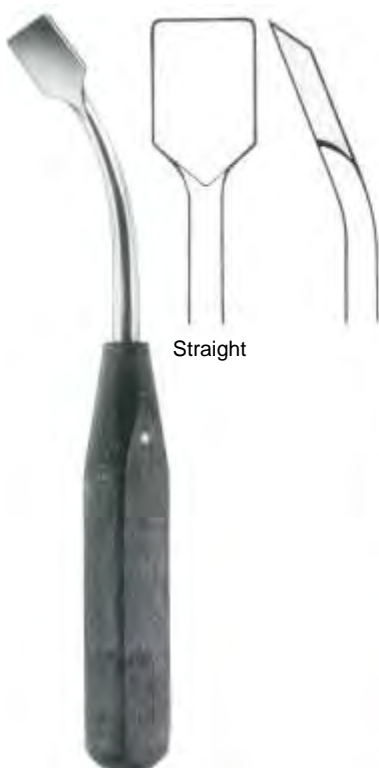

21-07206-05
18.5 cm/7¼"
13 mm



21-07207-06
19.5 cm/7¾"
14 mm



21-07209-07
18.5 cm/7¼"
14 mm



21-07211-08
20 cm/8"
20 mm



21-07214-20
27.5 cm/10¾"
20 mm



Wagner

8 mm 21-07218-08 33 cm/13" 10 mm
17 mm 21-07218-17 33 cm/13" 13 mm



Cobb

10 mm 21-07222-10 25 cm/10"
13 mm 21-07222-13 25 cm/10"
19 mm 21-07222-19 25 cm/10"
25 mm 21-07222-25 25 cm/10"



Cobb

10 mm 21-07224-10 28 cm/11"
13 mm 21-07224-13 28 cm/11"
19 mm 21-07224-19 28 cm/11"



21-07228-07
16 cm/6¼"
7 mm

21-07228-15
18.5 cm/7¼"
15 mm

21-07228-20
19 cm/7½"
20 mm

Hoehn



Yankauer
21-07232-18
18 cm/7"



Langenbeck
21-07236-20
20 cm/8"
8 mm



Langenbeck
21-07238-20
20 cm/8"
10 mm



Langenbeck
21-07240-23
23 cm/9"
11 mm



Mass. Gen. Hosp.
21-07244-15
15 cm/6"



Williger
21-07248-17
17 cm/6¾"
5.5 mm



Williger
21-07250-16
16 cm/6¼"



Quervain
21-07254-20
20 cm/8"



21-07258-16
16 cm/6¼"



Width
Key
6 mm 21-07262-06 19 cm/7½"
12 mm 21-07262-12 19 cm/7½"
19 mm 21-07262-19 19 cm/7½"
25 mm 21-07262-25 19 cm/7½"



Konig
21-07266-15
15 cm/6"
4.5 mm



Konig
21-07268-15
15 cm/6"
4.5 mm



Alderdyce
21-07272-21
21 cm/8¼"



McDonald
21-07276-19
19 cm/7½"



Watson-Cheyne
21-07280-19
17.5 cm/7"



Sebileau
21-07284-17
17 cm/6¾"



21-07288-14
14 cm/5½"
2.8 mm



21-07288-15
15 cm/6"
5 mm



21-07290-15
15 cm/6"
7 mm

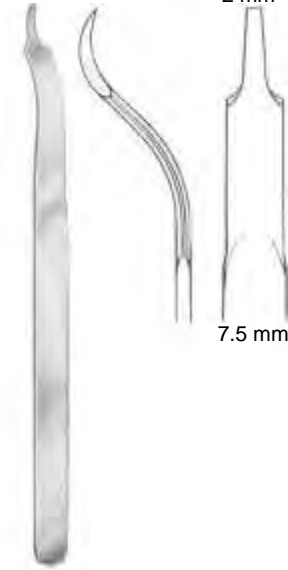

Buck-Gramcko
21-07292-15
15 cm/6"

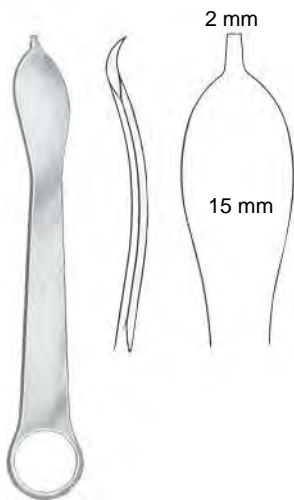

21-07296-12
12.5 cm/5"



Mini-Hohmann 21-07300-06
16 cm/6¼"
6 mm



21-07302-08
8 mm

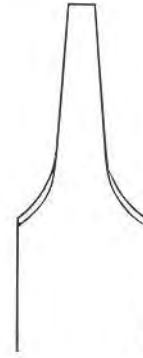

21-07306-17
17 mm

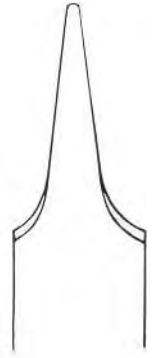

21-07308-17
17 mm



21-07304-26
26.5 cm/10½"
24 mm



Lange-Hohmann
21-07305-26
26 cm/10¼"
22 mm



Hohmann
21-07308-22
22 cm/8¾"
8 mm



Hohmann
21-07308-24
24 cm/9½"
14mm



Hohmann
21-07308-26
26 cm/10¼"
22 mm

Hohmann
21-07308-28
28 cm/11"
33 mm

Hohmann
21-07310-24
24 cm/9½"
43 mm

Hohmann
21-07312-24
24.5 cm/9¾"
43 mm

Hohmann
21-07314-24
24 cm/9½"
70 mm

Hohmann
21-07316-22
22 cm/8¾"
18 mm



Lange-Hohmann modif
30 mm 21-07316-26 26.5 cm/10½"
33 mm 21-07316-29 29.0 cm/11½"

Hohmann-Aldinger
21-07318-27 27 cm/10½"

Schumacher
(Wagner)
21-07318-34 34.5 cm/13½"

Schumacher
21-07320-29 29 cm/11½"

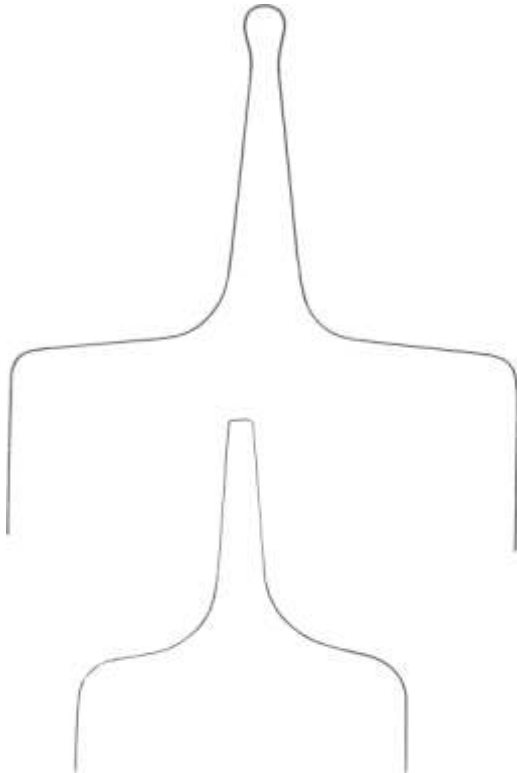

21-07322-25
25.5 cm/10"
65 mm

21-07322-24
24 cm/9 "
42 mm



Verbrugge-Muller



Lane Trethowan
21-07324-21
21.5 cm/8½"



Lane
21-07328-25
25.5 cm/10"



Bristow
21-07332-23
23 cm/9"



Murphy-Lane
21-07336-32
32 cm/12½"



Chandler

Length	Width	
18 cm	13 mm	21-07340-13
20 cm	19 mm	21-07340-19
23 cm	25 mm	21-07340-23
25 cm	30 mm	21-07340-30



Blount
21-07344-26
26 cm/10¼"



Blount
21-07346-26
26 cm/10¼"



Bennett 21-07350-44 44 mm
21-07350-64 64 mm



Smillie
14 cm/5½"

21-07354-01
32x19 mm

21-07354-02
48x19 mm

21-07354-03
57x19 mm



21-07356-04
52x13 mm



21-07358-05
12x13 mm

Spinal retractors



21-07362-01
75x30 mm

21-07362-02
100x30 mm

Taylor
17 cm/6½"



21-07366-21
21.5 cm/8½"

Meniscus retractors



Blount
21-07370-17
17.5 cm/7"



Smillie
21-07374-17
17 cm/6¾"



Smillie
21-07376-17
17 cm/6¾"



Smillie
21-07378-17
17 cm/6¾"



Salenius
21-07382-22
22 cm/8¾"



Salenius
21-07384-22
22 cm/8¾"



21-07388-17
17.5 cm/7"



Neff
21-07392-21
21.5 cm/8½"



Canad-Modell
21-07396-01 20 cm/8"



21-07396-02



Bircher
21-07402-20
20.5 cm/8"

Bone Instruments Bone Holding Forceps



Straight
21-07406-20
20 cm/8"



Curved on Falt
21-07407-20
20 cm/8"

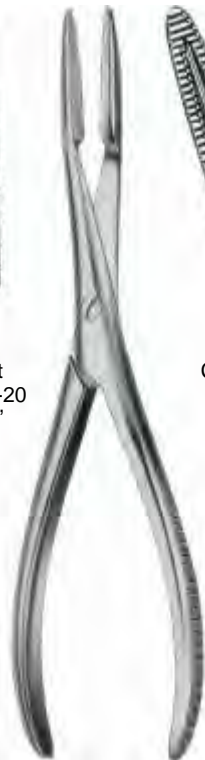

Van Buren
21-07410-23
23 cm/9"



Dingmann
21-07414-19
19cm/7½"



Dingmann Modif
21-07416-19
19 cm/7½"



Neff
21-07420-21
21 cm/8¼"



Martin
21-07424-19
19 cm/7½"



Preston
21-07428-18
18 cm/7¼"

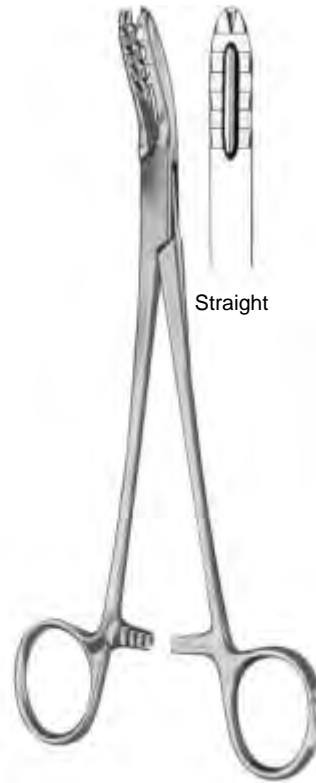

Bircher-Ganske
21-07432-20
20 cm/8"



Bircher-Ganske
21-07434-20
20 cm/8"



Lewin
21-07438-17
17.5 cm/7"



Langenbeck
21-07442-21
21 cm/8¼"



Fergusson
21-07446-21
21 cm/8¼"

Bone Instruments Bone Holding Forceps



21-07450-16
16 cm/6¼"
21-07450-24
24 cm/9½"



Without Ratchet	Kern	With Ratchet
21-07454-17	cm 17	21-07456-17
21-07454-21	in 6¾"	21-07456-21
	21 8¼"	



21-07460-18	18 cm/07"	21-07461-18
21-07460-23	23 cm/09"	21-07461-23
21-07460-25	25 cm/10"	21-07461-25
21-07460-28	28 cm/11"	21-07461-28



Hey Groves
21-07464-21 21.0 cm/8¼"
21-07464-27 27.0 cm/10½"
21-07464-30 30.5 cm/12"



Semb
21-07468-19
19 cm/7½"



Semb
21-07470-19
19 cm/7½"



Verbrugge
21-07474-17
17.5 cm/7"

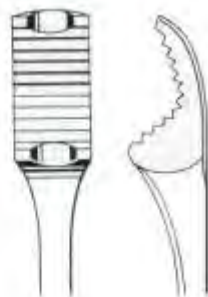

21-07478-25
25 cm/10"

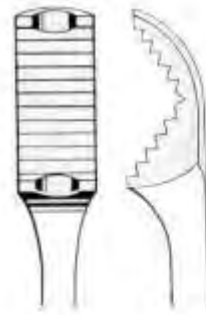

21-07478-26
26 cm/10¼"
Vebrugge

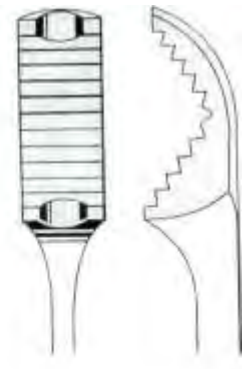

21-07478-27
27 cm/10½"



21-07482-15 15 cm/6"
21-07482-19 19 cm/7½"
21-07482-24 24 cm/9½"
21-07482-26 26 cm/10¼"
21-07482-28 28 cm/11"



Handles Detachable

Percy
21-07486-30

Adjustable



Lambotte
21-07490-22 22 cm/8¾"
21-07490-27 27 cm/10½"
21-07490-30 30 cm/12"



Farabeuf
21-07494-23 23 cm/9"
21-07494-26 26 cm/10¼"



Lambotte
21-07498-22 22.5 cm/9"
21-07498-25 25.5 cm/10½"
21-07498-33 33 cm/13½"



Farabeuf-Lambotte
21-07502-26
26 cm/10¼"



Lambotte
21-07506-19 19 cm/7½"
21-07506-23 23 cm/9"
21-07506-26 26 cm/10¼"



Without Ratchet	Lane	With Ratchet
	cm in	
21-07510-33	33 13"	21-07514-33
21-07510-45	45 17¾"	21-07514-45



21-07518-14
14.5 cm/5¾"



21-07522-12
12 cm/4¾"

Bone Instruments Bone Holding Forceps and Bone Holding Clamps



21-07526-13
13.5 cm/5 1/4"



21-07530-20
20 cm/8"



21-07534-17
17 cm/6 3/4"



Patella Forceps

21-07538-17
17.5 cm/7"



Lowman-Hoglund
21-07542-19
19 cm/7 1/2"



Lowman
21-07546-18 18 cm/7"
21-07546-20 20 cm/8"
21-07546-22 22 cm/8 3/4"



Lowman
21-07550-12
12 cm/4 3/4"



Traction Bar

21-07554-18
21-07554-50



21-07557-17

21-07559-17

Stellbrink
17.5 cm/7"



Bane-Hartmann
21-07563-17
17.5 cm/7"



Mini-Friedmann
21-07567-12
12.5 cm/5"



Friedmann
21-07571-14
14 cm/5½"



Friedmann-Delicate
15 cm/6"



21-07575-15

90°

21-07577-15



Bacon
21-07580-20
20 cm/8"



Cleveland
21-07583-14 14 cm/5½"
21-07583-17 17 cm/6¾"



Hartmann
21-07587-18
18.5 cm/7¼"



Olivecrona
21-07591-20
20 cm/8"



21-07595-16



21-07597-16

Mead
16.5 cm/6½"



Lempert

	cm	in	Curved
Straight	16	6¼"	21-07603-16
	19	7½"	21-07603-19



Beyer
21-07607-18
18 cm/7"



21-07610-17



21-07611-17

Jansen
17.5 cm/7"



21-07615-15



21-07617-15



21-07619-15

Blumenthal
15.5 cm/6"



Hakansson
21-07621-15
15.5 cm/6"

Bone Instruments Bone Rongeur Forceps



Jansen
21-07623-18
18 cm/7"



Luer
17 cm/6¾"



Straight
21-07626-17

Curved
21-07627-17



Luer
18.5 cm/7¼"

Heavy Pattern

Straight
21-07630-18

Curved
21-07631-18



Luer
15 cm/6"



21-07635-15

21-07637-15

21-07639-15



Adson
20 cm/8"



21-07642-20



Kleinert-Kutz
15 cm/6"



21-07645-15
2 mm



21-07647-15
3 mm



Bohler
15 cm/6"



21-07650-15



21-07651-15



**Beyer
Zaufal-Jansen**
18 cm/7"



Zaufal-Jansen
21-07653-18



Beyer
21-07655-18



Mayfield
21-07659-17
17 cm/6¾"



Ruskin
21-07663-18
18 cm/7"
Angled



Straight
21-07666-18
18 cm/7"
21-07666-23
23 cm/9"



Ruskin

Curved
21-07667-18
18 cm/7"
21-07667-23
23 cm/9"



Marquardt
21-07671-20
20 cm/8"



Rottgen-Ruskin
21-07675-24
24 cm/9½"



21-7679-03
3 mm



21-7679-04
4 mm



21-7679-05
5 mm



21-7681-03
3 mm



21-7681-04
4 mm



21-7681-05
5 mm



Smith-Petersen
24 cm/9½"



Stille-Luer
22 cm/8¾"



Straight
21-07684-22



Curved
21-07685-22



Stille-Luer
27 cm/10½"



21-07688-27



21-07689-27



Semb
21-07693-23
23 cm/9"



Stille-Ruskin
21-07697-23
23 cm/9"



Echlin
23 cm/9"

- 21-07701-02
2 mm
- 21-07701-03
3 mm
- 21-07701-04
4 mm



Leksell
23 cm/9"

- 21-07705-03
3 mm
- 21-07705-04
4 mm
- 21-07705-06
6 mm
- 21-07705-08
8 mm



Frykholm
21-07709-23
23 cm/9"



Stille
21-07713-23
23 cm/9"

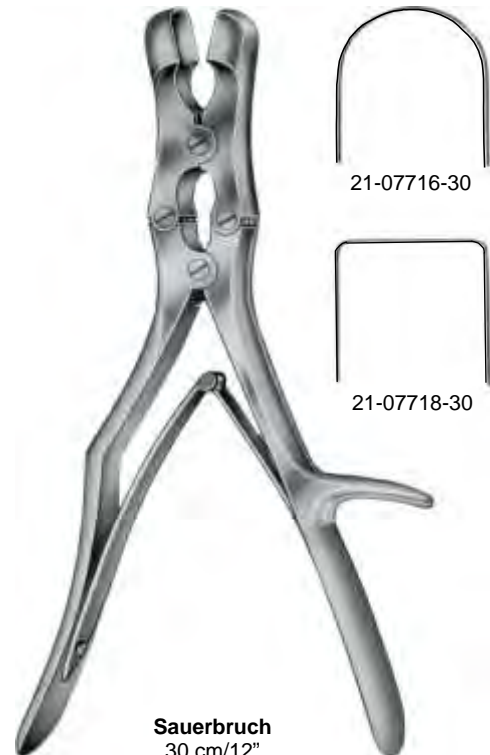

Sauerbruch
30 cm/12"

21-07716-30

21-07718-30



Markwalder
21-07721-20
20 cm/8"



Straight cm
21-07724-14 14
21-07724-17 17
21-07724-19 19
21-07724-22 22



Liston in Curved
21-07725-14 5½ 21-07725-14
21-07725-17 6¾ 21-07725-17
21-07725-19 7½ 21-07725-19
21-07725-22 8¾ 21-07725-22



Littauer-Liston
21-07728-15
15 cm/6"



Cleveland
21-07731-15 15 cm/6"
21-07731-17 17 cm/6¾"



Bohler
15 cm/6"



Straight Curved on flat
21-07734-15 21-07735-15



McIndoe
21-07739-17
17.5 cm/7"



Kazanjan
21-07742-18
18 cm/7"



Ruskin-Liston
18.5 cm/7 1/4"

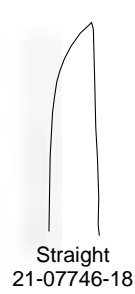

Straight
21-07746-18

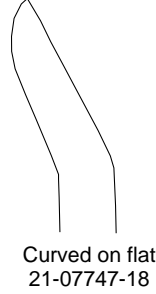

Curved on flat
21-07747-18



Stille-Liston
23 cm/9"
27 cm/10 1/2"

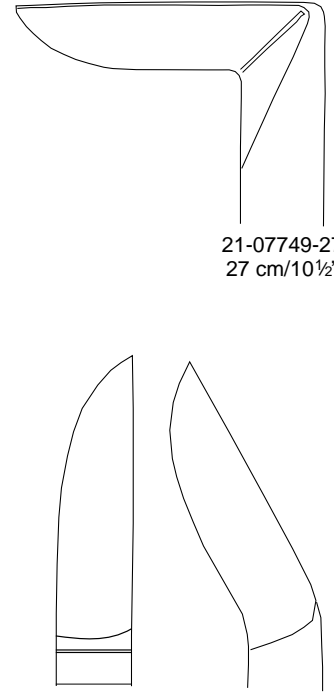

21-07749-27
27 cm/10 1/2"

21-07750-23
21-07750-27

21-07751-23
21-07751-27



Liston-Key(Horsley)
21-07753-27
27 cm/10 1/2"



Semb
21-07755-24
24 cm/9 1/2"

Forceps for tearing out toe and finger nails

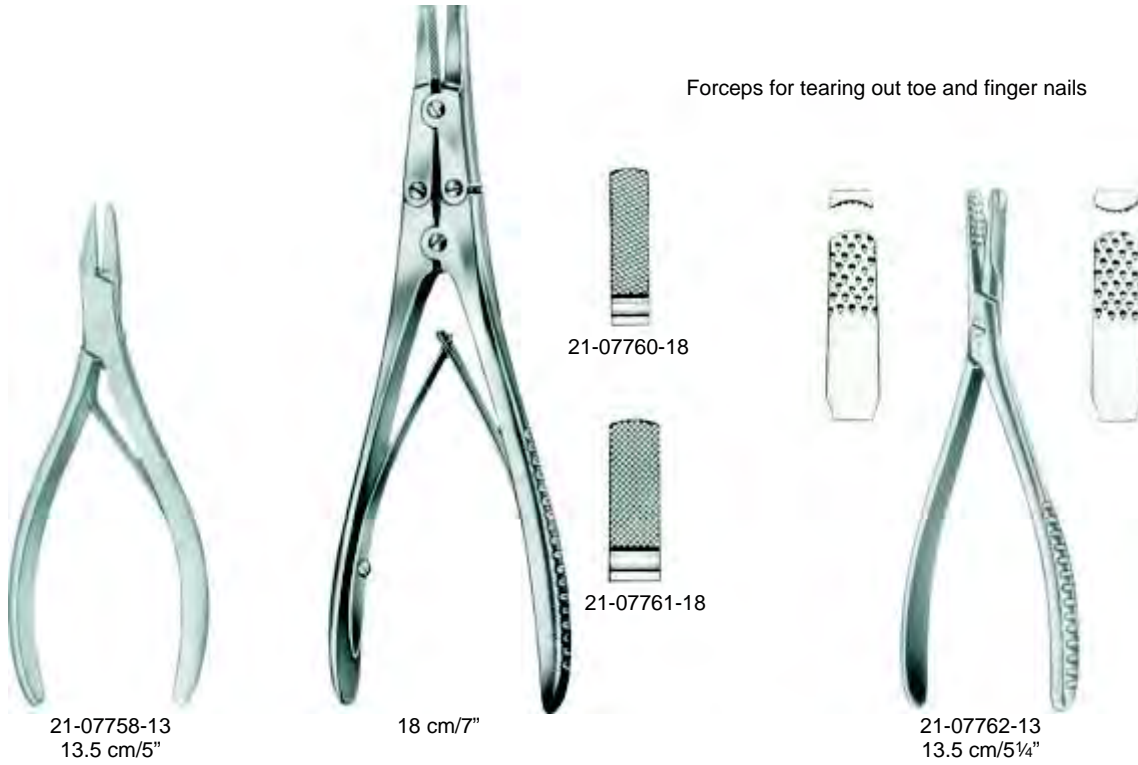

Saw blade



21-07764-17
17 cm/6¾"

Saw blade



21-07766-17
17 cm/6¾"



Langenbeck
21-07768-23
23 cm/9"



Satterlee
21-07770-31
31 cm/12¼"



Charriere
21-07772-27 27 cm/10½"
21-07772-30 30 cm/12"



Charriere

Spare saw blades
21-07774-12 12 mm
21-07774-15 15 mm
Complete with 2 blades
21-07774-35



Helferich-Bier

Spare saw blades
21-07776-43 3 mm
21-07776-45 5 mm
21-07776-47 7 mm
Complete with 3 blades
21-07776-39



Hudson
21-0778-00
Hand drill, with 4 burrs, fig. 1-4

Handle, only
21-0778-10

Conical and spherical burrs, single

Flat trephine

Extension piece



Fig. 1
21-07778-01
9 mmØ



Fig. 2
21-07778-02
14 mmØ



Fig. 3
21-07778-03
16 mmØ



Fig. 4
21-07778-04
22 mmØ



Cushing
Fig. 5
21-07778-05
14 mmØ

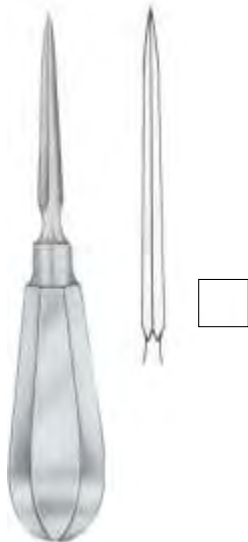

Fig. 6
21-07778-06

Drill guide and dura protecting forceps



Adson
21-07780-15
15 cm/6"



21-07784-14
14 cm/5½"



Perthes
21-07786-21
21 cm/8¼"



21-07788-14
14 cm/5½"



21-07792-14
14 cm/5½"



21-07794-16
16 cm/6¼"



18cm/7"

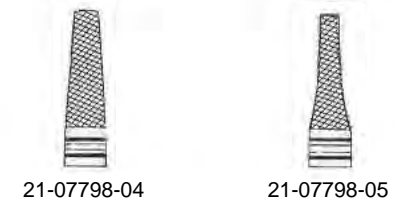
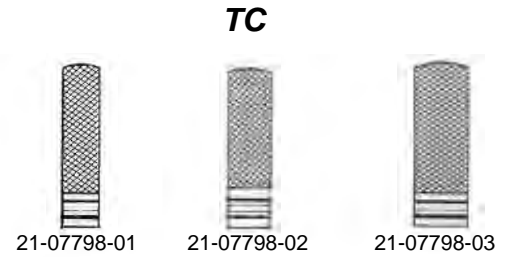

TC



21-07802-18 18 cm/7"
21-07802-20 20 cm/8"

TC



Bone Instruments Wire Seizing Forceps



21-07814-13 13 cm/5"
21-07814-18 18 cm/7"



21-07818-17
17 cm/6³/₄"

TC



21-07822-15
15.5 cm/6"



21-07826-17 17 cm/6³/₄"



21-07828-17



21-07830-19
19 cm/7 1/2"



For soft wire
with a diam. of max.

21-07834-15
15 cm/6"
2.0 mm

21-07836-18
18.5 cm/7¼"
1.7 mm

21-07837-16
16 cm/6¼"
2.0 mm

For hard wire
with a diam. of max.

1.5 mm

1.7 mm

2.0 mm

TC



21-07840-12
0.7 mm
0.5 mm
12 cm/4¾"



21-07844-15
2.0 mm
1.0 mm
15 cm/6"



21-07848-18
2.0 mm
1.7 mm
18 cm/7"



21-07852-18
2.5 mm
1.5 mm
18.5 cm/7¼"



21-07856-18
2.0 mm
1.7 mm
18 cm/7"



21-07860-22
3.0 mm
2.5 mm
22 cm/8¾"



21-07864-22
3.0 mm
22 cm/8¾"



With 1 Pin

Bohler

cm	in	
h x b	h x b	For Arm
16 x 9	6¼ x 3½	21-07868-16

cm	in	
h x b	h x b	For Thigh and Knee
21 x 11	8¼ x 4½	21-07868-21



With 3 Traction Hooks

Kirschner

Clear Width	cm	in
21-07872-01	9.5x7	3¾x2¾
21-07872-02	10.5x10.5	4¼x4¼
21-07872-03	12x12	4¾x4¾
21-07872-04	15.5x15.5	6x6
21-07872-05	20x15.5	8x6



With 3 Traction Hooks

Kirschner

21-07880-01	Small Pattern
21-07880-02	Medium Pattern
21-07880-03	Large Pattern



Clear Width

	cm	in
21-07876-18	18x10	07x04
21-07876-27	27x16	10½x06¼

Screw Nut Wrench



21-07884-10
10 cm/4"

Screw Driver



21-07884-12
12 cm/4¾"

Wire Strainer



21-07884-20
20 cm/8"

Fixation Discs For Drill Wires



21-07884-30
Pair



21-07884-40



21-07884-42

Fixation Discs



21-07884-51
Pair

Bone Wire Guides



Bone Wire Tighteners



Loute
21-07888-00
21 cm/8 1/4"



Demel

Bone Wire Guides

- Fig. 1 21-07892-01
- Fig. 2 21-07892-02
- Fig. 3 21-07892-03

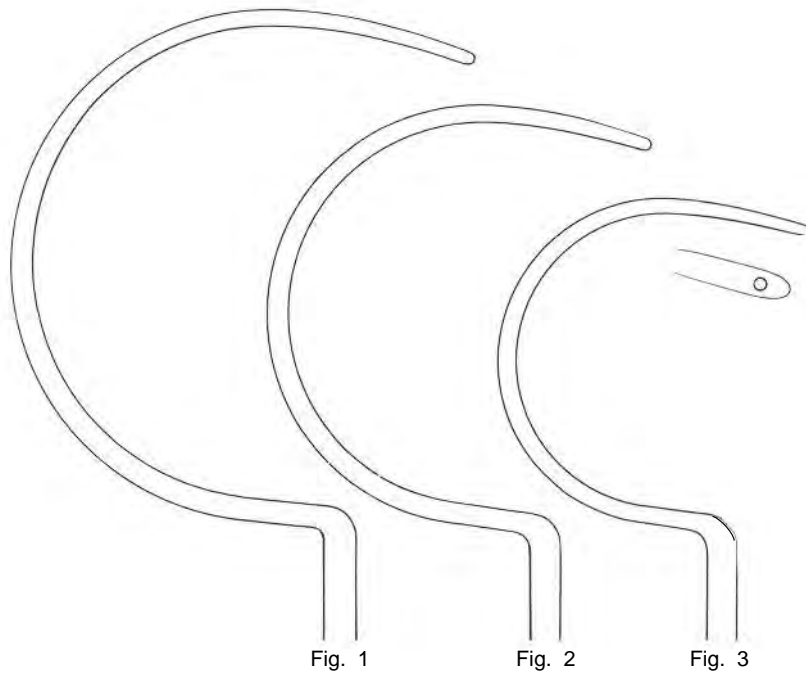

Fig. 1

Fig. 2

Fig. 3



100 g 21-07896-10
350 g 21-07896-35
500 g 21-07896-50
700 g 21-07896-70

22 cm/8½"



Heath
21-07900-18
18 cm/7" Ø 40 mm



Ombredanne
21-07904-24
Ø 40 mm
24 cm/9½"
550 g



1 Side Flat
1 Side Convex

Cottle
21-07908-19
Ø 30 mm
19 cm/7½"
350 g



Williger
21-07912-23
23 cm/9"
150 g



Hajek
21-07916-21
Ø 27 mm
21 cm/8¼"
140 g



165 g
Ø 22 mm

21-07920-19
19 cm/7½"



Fig. 1 21-07924-19 19mm Ø
Fig. 2 21-07924-25 25mm Ø

Lucae
19 cm/7½"



21-07928-16
16.5 cm/6½"



320 g
Ø 26 mm

Solid With
Interchangeable
Ferrozell Jaws

Mead
21-07932-17
17 cm/6¾"



280 g
Solid Steel

Gardner
21-07936-14
14 cm/5½"



200 g
22 mm Ø
(7 oz.)

Partsch
21-07940-18
18 cm/7"



Gerzog
21-07944-19
19 cm/7½"

Bone Instruments Tendon Seizing Instruments



7 mm Ø



Spare Screw

21-07948-34
34cm/13½"

Tendon Passing Instruments

Malleable



Bunnell
21-07950-18 18cm/7"
21-07950-23 23cm/9"

Tendon Strippers

mm Ø
4.0 21-07952-40
4.5 21-07952-45
5.5 21-07952-55
Flexible Shaft



Bunnell
23cm/9"



Fischer
21-07956-31
31 cm/12¼"



Brand

21-07960-50
50 cm/19½"
06 mm Ø

21-07962-30
30 cm/12"
03 mm Ø



Brand
21-07964-50
50 cm/19½"

6 x 14 mm



Steinmann
21-07968-16
16 cm/6¼"



Larsen
10 cm/4"



Kleinert-Kutz
21-07976-20
20 cm/8"



Brand
21-07980-15 15 cm/6"
21-07980-19 19 cm/7½"
21-07980-24 24 cm/9½"



Brand
21-07981-15 15 cm/6"
21-07981-19 19 cm/7½"
21-07981-24 24 cm/9½"



21-07984-20



21-07985-20



20 cm/8"



Steinmann
21-07988-13
13 cm/5"



Caroll
21-07992-11
11 cm/4½"

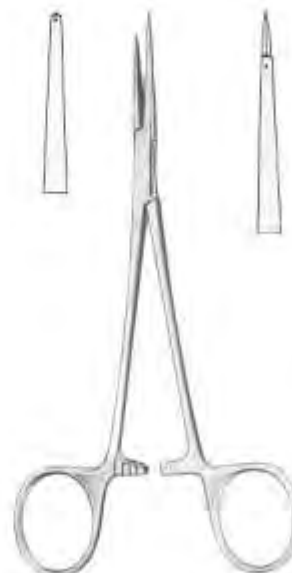

21-07996-15
15 cm/6"



21-07997-15
15 cm/6"



Laborde
22-08000-13 13 cm/5"
22-08000-15 15 cm/6"



Trousseau
22-08004-14
14 cm/5½"



Trousseau-Baby
22-08006-13
13 cm/5"

Hooks



Left

Right

Sharp



Bose
22-08010-07
7 cm/2¾"



22-08013-16



22-08015-16

Bose
16 cm/6¼"



Schoenborn
22-08018-21
21 cm/8¼"











Thyroid Gland Retractor

Trachea Trocars



Uckerman
22-08022-08 08 mm Ø
22-08022-10 10 mm Ø
13 cm/5"

Tracheotomy Instruments Trachea Tubes

Fig	0	1	2	3	4	5	6	7	8	9
										
Ø mm	04	05	06	07	08	09	10	11	12	13
Charr./Fr.	12	15	18	21	24	27	30	33	36	39
	45	50	55	60	65	70	75	80	85	90

Length of Outer Tube

Standard Pattern



Luer

Fig.	mm Ø	
0	4	22-08026-04
1	5	22-08026-05
2	6	22-08026-06
3	7	22-08026-07
4	8	22-08026-08
5	9	22-08026-09
6	10	22-08026-10
7	11	22-08026-11
8	12	22-08026-12
9	13	22-08026-13

Chevalier-Jackson



Luer

Fig.	mm Ø	
0	4	22-08028-04
1	5	22-08028-05
2	6	22-08028-06
3	7	22-08028-07
4	8	22-08028-08
5	9	22-08028-09
6	10	22-08028-10
7	11	22-08028-11
8	12	22-08028-12
9	13	22-08028-13



Luer

Fig.	mm Ø	
4	8	22-08030-08
5	9	22-08030-09
6	10	22-08030-10
7	11	22-08030-11
8	12	22-08030-12
9	13	22-08030-13



Goitre Probes

Kocher
23-08034-15 15 cm/6"
23-08034-16 16 cm/6¼"



Goitre Grasping Forceps

Lahey
23-08038-15 15 cm/6"
23-08038-20 20 cm/8"



Muscle Forceps
23-08042-17

Mastin
17 cm/6¾"

Comedone Extractors



Schamberg
24-08046-10
10 cm/4"



Unna
24-08050-14
14 cm/5½"



Unna
24-08052-14
14 cm/5½"



Sealfeld
24-08056-10
10 cm/4"



Saalfeld
24-08060-14
14 cm/5½"



Katsch
24-08064-14
14 cm/5½"



Hebra
24-08068-18
18 cm/7"

Skin Currettes



Fig. 1 24-08072-01



Fig. 2 24-08072-02

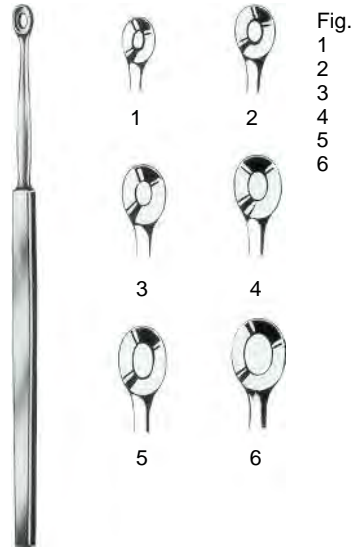

Fig. 3 24-08072-03



Piffard
14.5cm/5¾"

Lupus Currettes



Wolff
14 cm/5½"

- | | |
|------|-------------|
| Fig. | |
| 1 | 24-08076-01 |
| 2 | 24-08076-02 |
| 3 | 24-08076-03 |
| 4 | 24-08076-04 |
| 5 | 24-08076-05 |
| 6 | 24-08076-06 |

Lupus Currettes

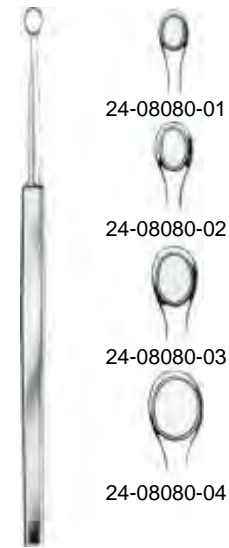

Fox
14 cm/5½"

- | | |
|--|-------------|
| | 24-08080-01 |
| | 24-08080-02 |
| | 24-08080-03 |
| | 24-08080-04 |

Lupus Scraper



Vidal
24-08084-14
14 cm/5½"

Moncorps Knife



Moncorps
24-08088-14
14 cm/5½"

Fig. 1

Fig. 2



Gillies
Fig. 1 24-08092-01
Fig. 2 24-08092-02
18 cm/7"

Cutaneous Hook



Kilner
24-08094-15
15 cm/6"



		Allis	
		4 : 5	5 : 6
cm	in	25-08096-15	25-08100-15
15	6"		
19	7½"		25-08100-19
23	9"		25-08100-23
25	10"		25-08100-25



		Baby-Allis	
25-08104-12	12 cm/4¾"		
25-08104-14	14 cm/5½"		



		Allis-Atrauma	
25-08108-16	16 cm/6¼"		
25-08108-20	20 cm/8"		
25-08108-25	25 cm/10"		
25-08108-30	30 cm/12"		



Allis-Adair
25-08112-15
15 cm/6"



Baby-Allis
25-08116-15
15 cm/6"



Lockwood-Allis
25-08120-16 16 cm/6¼"
25-08120-20 20 cm/8"



Thoms-Allis
25-08124-20
20 cm/8"



Judd-Allis
25-08128-15 15 cm/6"
25-08128-19 19 cm/7½"



Littlewood
25-08132-18
18.5 cm/7¼"



Williams
25-08136-16
16 cm/6 ¼"



Lockwood
25-08140-20
20 cm/8"

Atrauma



cm/in **Babcock-Atrauma**
16 cm/6¼" 25-08144-16
18 cm/7" 25-08144-18
20 cm/8" 25-08144-20
24 cm/9½" 25-08144-24



Babcock(Standard)
25-08148-16
25-08148-18
25-08148-20
25-08148-24



Baby-Babcock
25-08152-16



Babcock
25-08156-16

25-08156-20

Atrauma

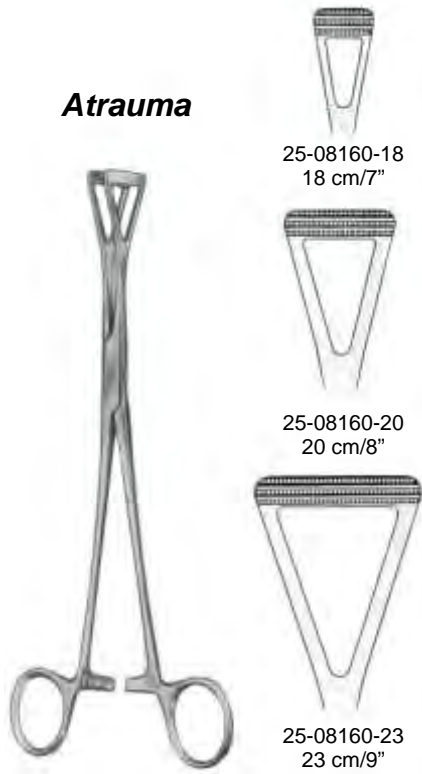

		Duval			
		cm	in		
25-08164-18	18	7"		25-08168-20	
25-08164-20	20	8"		25-08168-23	
25-08164-23	23	9"			

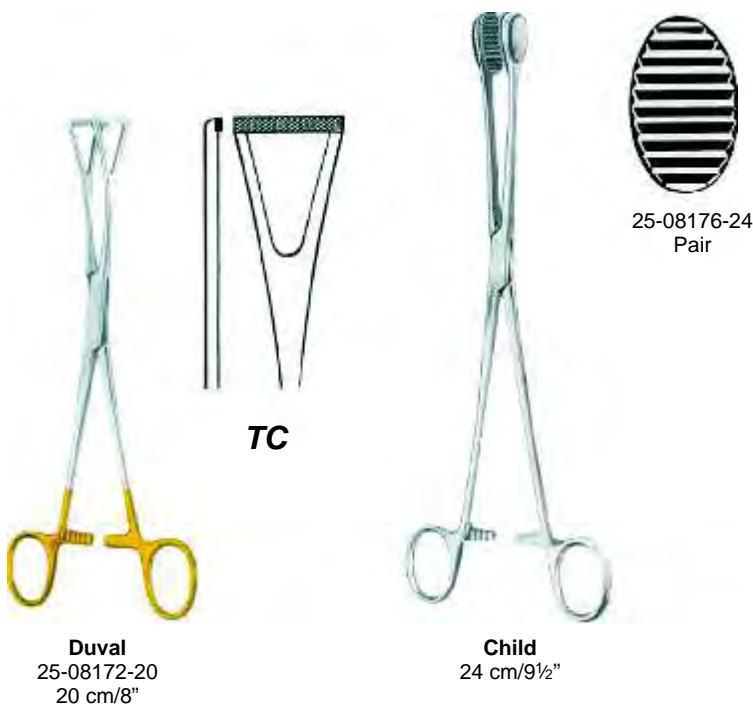

Atrauma

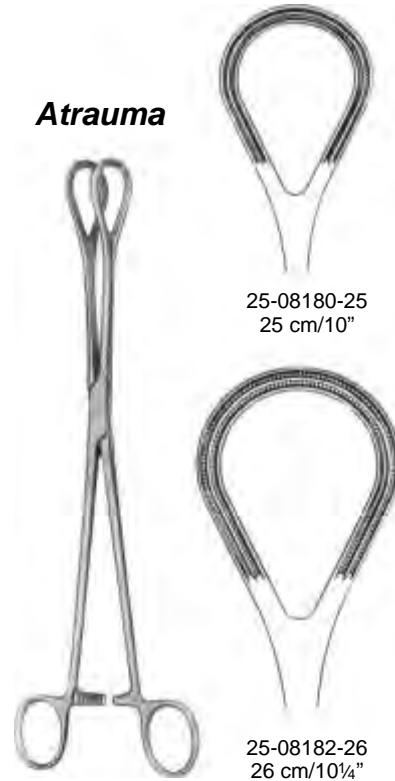



Baby-Doyen
Straight 25-08186-18 18 cm/7"
Curved 25-08187-18 18 cm/7"

Doyen
Straight 25-08190-21 21 cm/8 1/4"
25-08190-23 23 cm/9"
Curved 25-08191-21 21 cm/8 1/4"
25-08191-23 23 cm/9"

Scudder
25-08194-25 25 cm/10"

Atrauma

Straight



Doyen-Atrauma

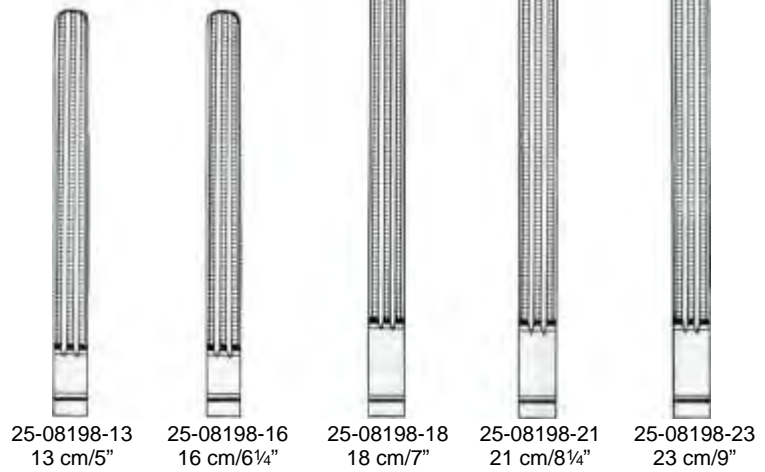

Atrauma

Curved

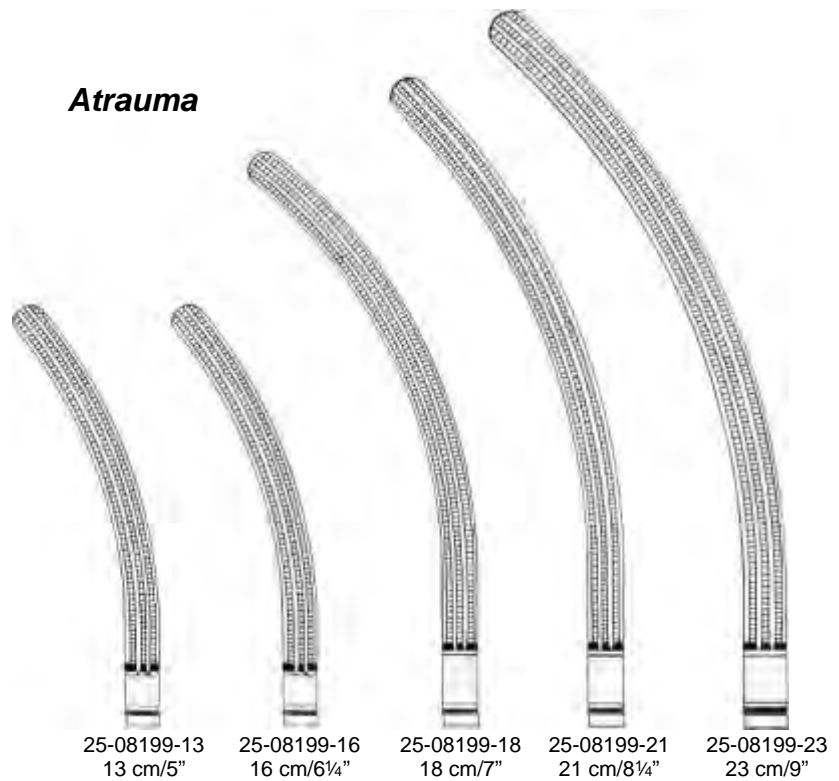



Mayo-Robson
Mayo-Robson Atrauma

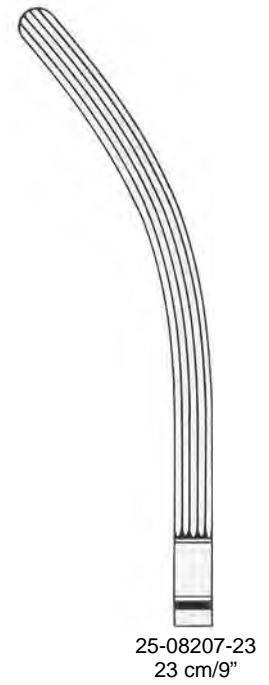
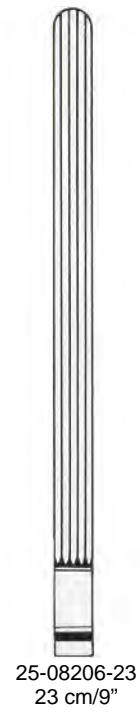
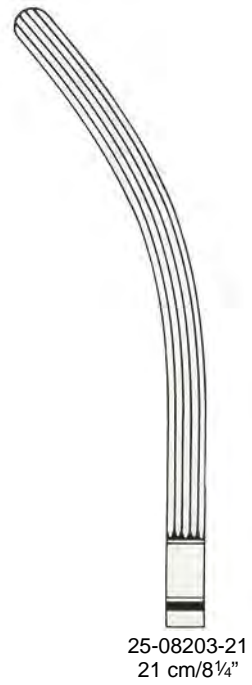

Atrauma

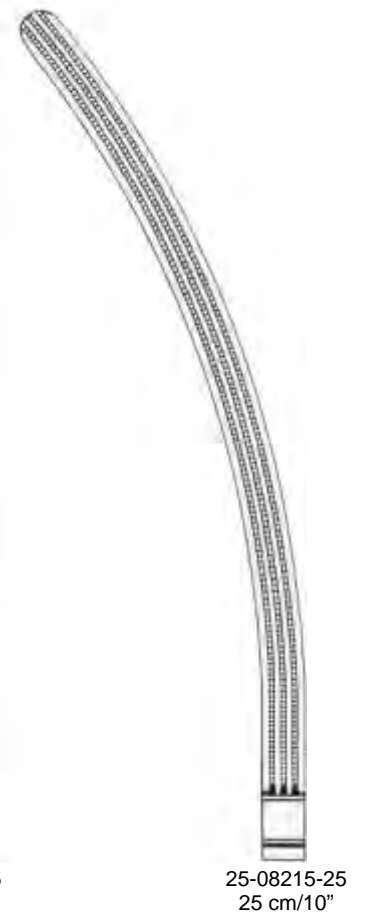
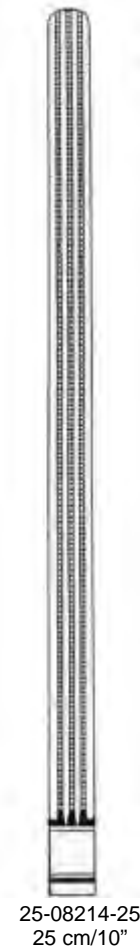
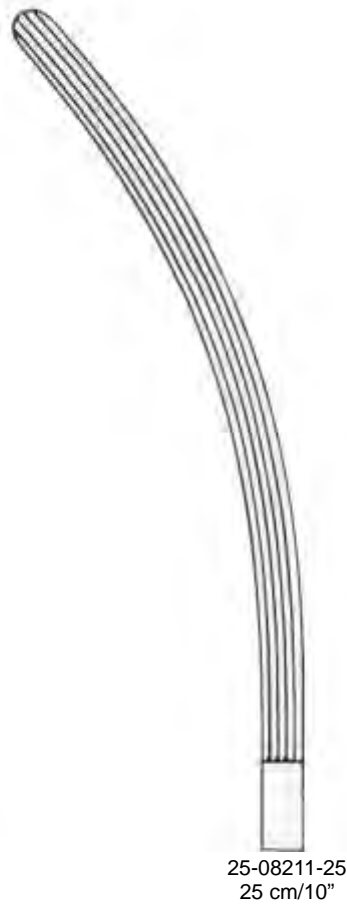
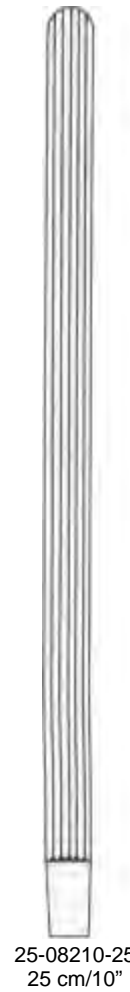



Resano
25-08219-30
30 cm/12"



Hayes



25-08223-26
26 cm/10¼"

25-08223-28
28 cm/11"

Atrauma

Atrauma



Fehland
25-08227-24
24 cm/9½"



Brunner
24 cm/9½"



25-08231-24



25-08233-24



Straight **Baby-Kocher** Curved
25-08236-13 25-08237-13
13 cm/5" 13 cm/5"



Kocher



25-08240-22
22 cm/8³/₄"



25-08240-25
25 cm/10"



25-08240-28
28 cm/11"



25-08241-22
22 cm/8³/₄"



25-08241-25
25 cm/10"

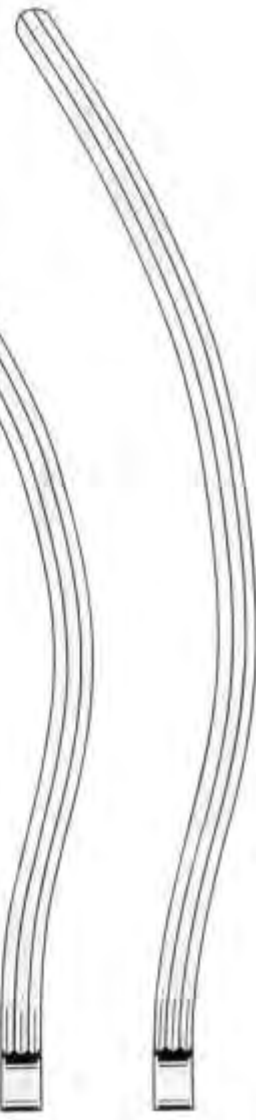

25-08241-28
28 cm/11"

Atrauma



Kocher-Atrauma

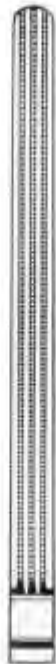

25-08244-22
22 cm/8¾"

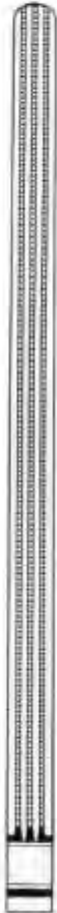

25-08244-25
25 cm/10"



25-08244-28
28 cm/11"



25-08245-22
22 cm/8¾"

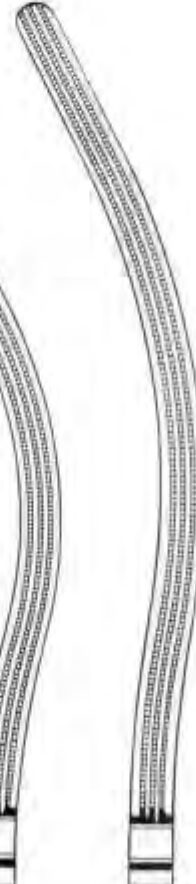

25-08245-25
25 cm/10"



25-08245-28
28 cm/11"



Straight
25-08248-25



Nussbaum
25 cm/10"



Curved
25-08249-25



Pylorus spreader

Benson
25-08252-15
15.5 cm/6"

Blindgut forceps



Allen
25-08253-15 15.5 cm/6"
25-08253-20 20.0 cm/8"



Kleinschmidt
25-08255-12
12 cm/4¾"



Payr
(Payr-Baby)

For children



25-08258-15
15 cm/6"



25-08258-21
21 cm/8¼"

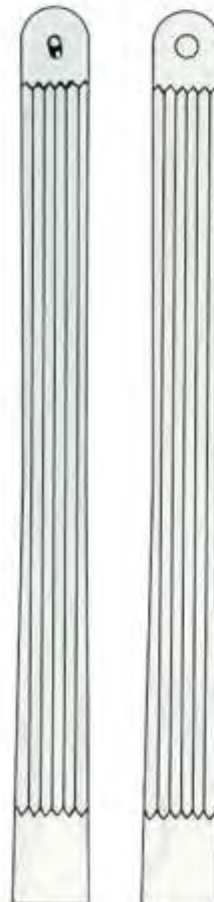

25-08258-29
29 cm/11½"

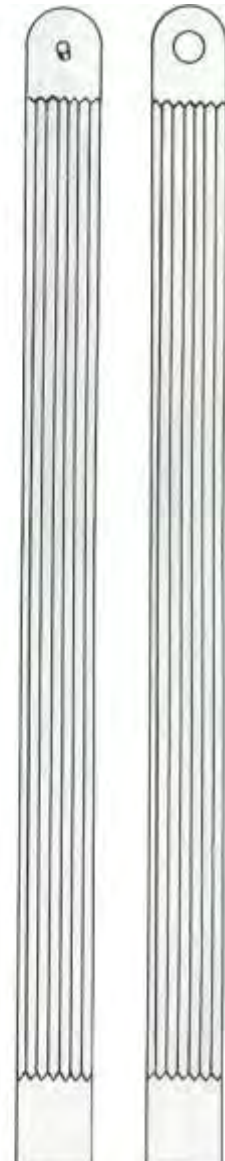

25-08258-35
35 cm/13¾"

Twin Clamps Forceps



Lane
30 cm/12"



Straight
25-08862-30

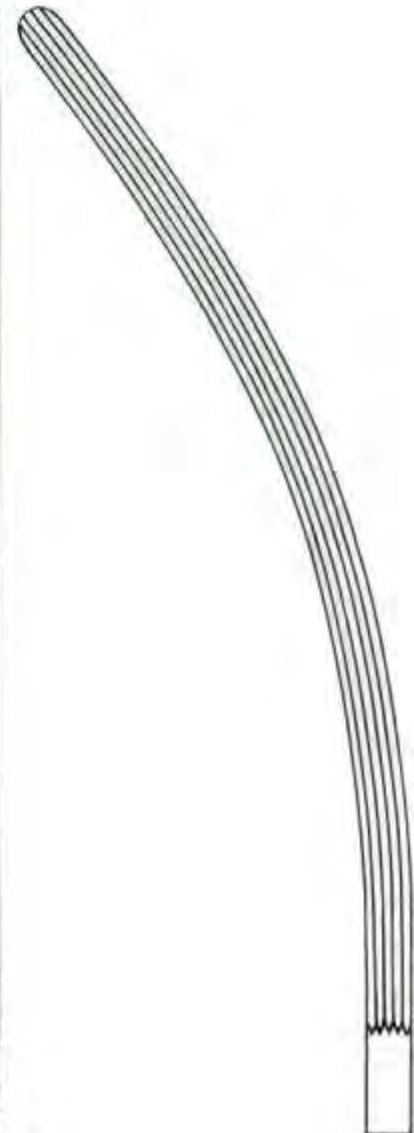

Curved
25-08863-30

Atrauma



Intestinal and Stomach Twin Clamps



Haberer
25-08274-36
36 cm/14"

Straight
25-08278-30

Nussbaum
30 cm/12"

Curved
25-08279-30



Czerny
25-08282-22
22 cm/8¾"



Pratt
25-08286-20
80 x 25 mm
20.5 cm/8"



Sims
25-08291-15

**(Bodenhammer)
Sims**
25-08290-15
15 cm/6"



Sims
22 cm/8¾"



Mathieu
25-08298-19
90 x 15 mm
19.5 cm/7¾"

Length of Blades	
25-08294-06	60 mm
25-08294-08	80 mm
25-08294-12	125 mm
25-08294-15	150 mm



Barr
25-08302-17
17 cm/6¾"
70 X 22 mm



Smith-Bule
25-08306-15
15 cm/6"

Anuscopes



Hirschmann
Fig. 1 16 mm Ø x 65 mm 25-08310-01
Fig. 2 19 mm Ø x 65 mm 25-08310-02
Fig. 3 22 mm Ø x 65 mm 25-08310-03
Fig. 4 25 mm Ø x 65 mm 25-08310-04



Bensaude
Fig. 1 19 mm Ø x 70 mm 25-08314-01
Fig. 2 22 mm Ø x 70 mm 25-08314-02



Anuscope

Ives-Fansler
25-08318-22
22 mm Ø



Proctoscopes

Fig. 1 22 mm Ø x 50 mm	25-08322-01
Fig. 2 22 mm Ø x 100 mm	25-08322-02
Fig. 3 22 mm Ø x 140 mm	25-08322-03
Fig. 4 22 mm Ø x 200 mm	25-08322-04

Kelly



Sphincteroscopes

Kelly

Fig. 1 21 mm Ø 50 mm	25-08326-01
Fig. 2 27 mm Ø 50 mm	25-08326-02



Consisting of:

Spreader only
25-08330-01

Center Blade only
25-08330-02

Pair of Blades Only 75 mm
25-08330-03

Pair of Blades only 95 mm
25-08330-04

Park
25-08330-00
14.5 cm/5¾"



Consisting of:

Spreader only
25-08334-01

Pair of Blades only 95 mm
25-08334-02

Park
25-08334-00
13 cm/5"

Length of Shaft

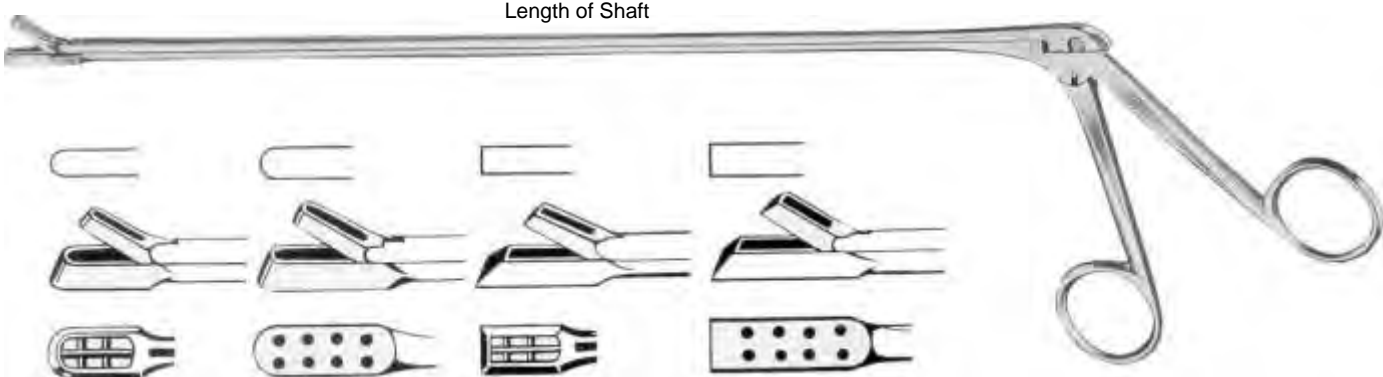



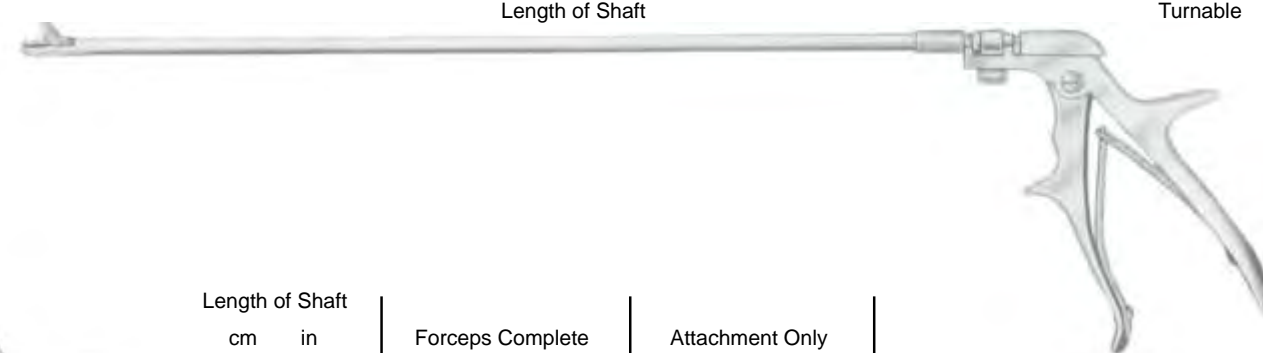

		cm		in				
1	2	28	35	42	11	13 3/4"	16 1/2"	Yeoman
25-08338-28	25-08340-28							
25-08338-35	25-08340-35							
25-08338-42	25-08340-42							
3	4							
25-08342-28	25-08344-28							
25-08342-35	25-08344-35							
25-08342-42	25-08344-42							

Length of Shaft

Turnable



	Length of Shaft		Forceps Complete	Attachment Only
	cm	in		
	33	13	25-08348-33	25-08358-33
	40	16	25-08348-40	25-08358-40
	33	13	25-08350-33	25-08360-33
	40	16	25-08350-40	25-08360-40
	33	13	25-08352-33	25-08362-33
	40	16	25-08352-40	25-08362-40
	33	13	25-08354-33	25-08364-33
	40	16	25-08354-40	25-08364-40

Yeoman (Turrell)
Handle Only
25-08348-00

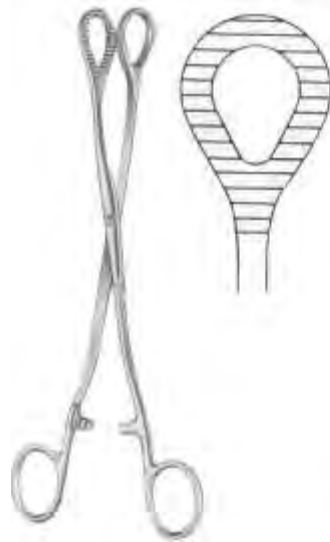

Heywood-Smith
25-08366-21
21 cm/8¼"



Heywood-Smith
25-08368-21
21 cm/8¼"

Rectal Snare

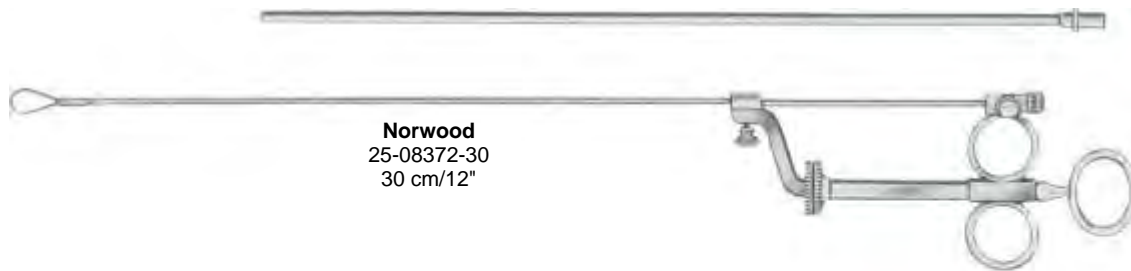

Norwood
25-08372-30
30 cm/12"

Rectal Aspiration Cannula



Buie
25-08376-40
Charr. 10. 40 cm/15¾"

Rectal Coolers



25-08380-01



25-08380-02

Aspiration Tip



	a	Ø
25-08384-11	11 mm	10 mm
25-08384-16	16 mm	10 mm

Charging Cone



10 mm Ø

25-08392-10

Charging Cone



12 mm Ø

25-08392-12

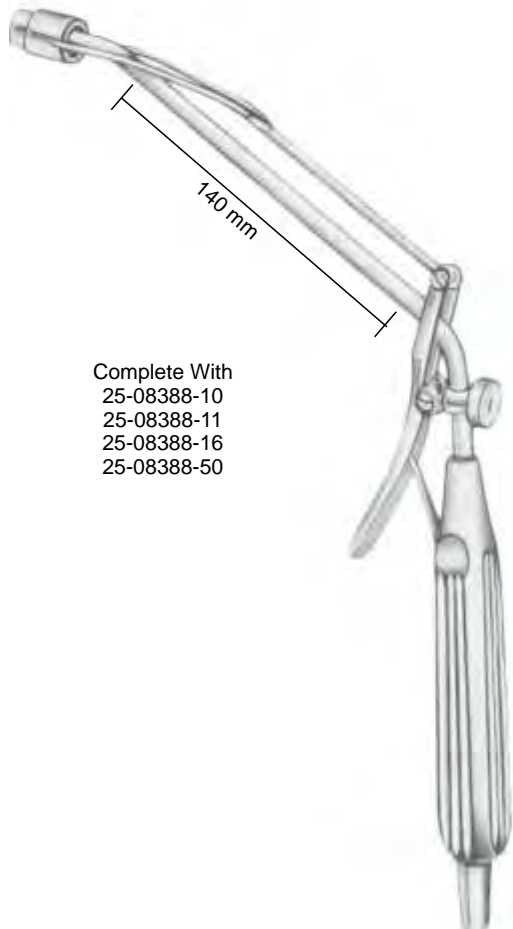

Complete With
25-08388-10
25-08388-11
25-08388-16
25-08388-50



Complete With
25-08396-00
25-08392-12
25-08396-50

Rudd
31.5 cm/12½"

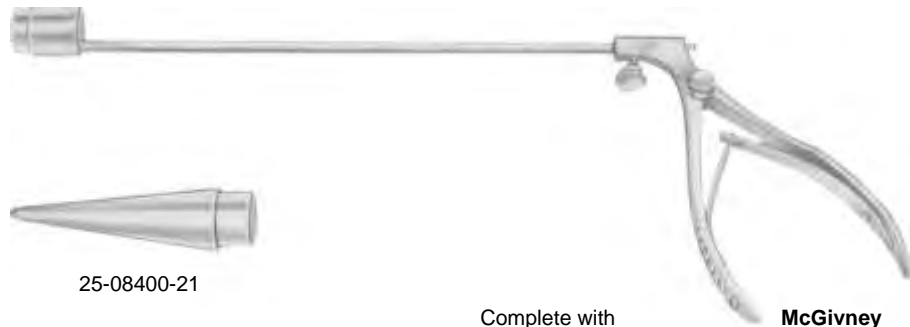

25-08400-21

Complete with
25-08400-00

McGivney
25-08400-01

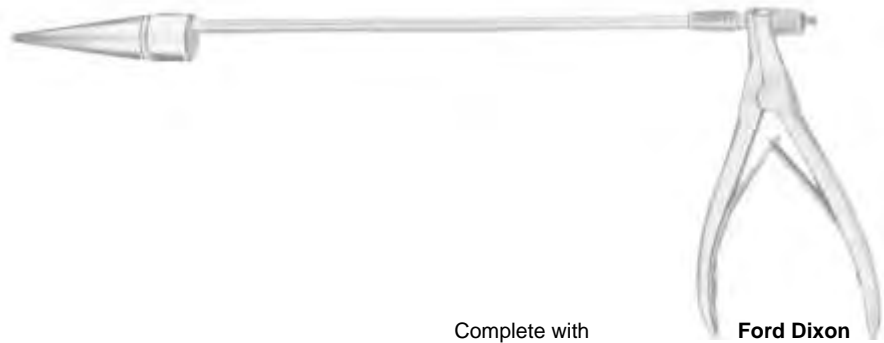

Complete with
25-08404-00

Ford Dixon
25-08404-01

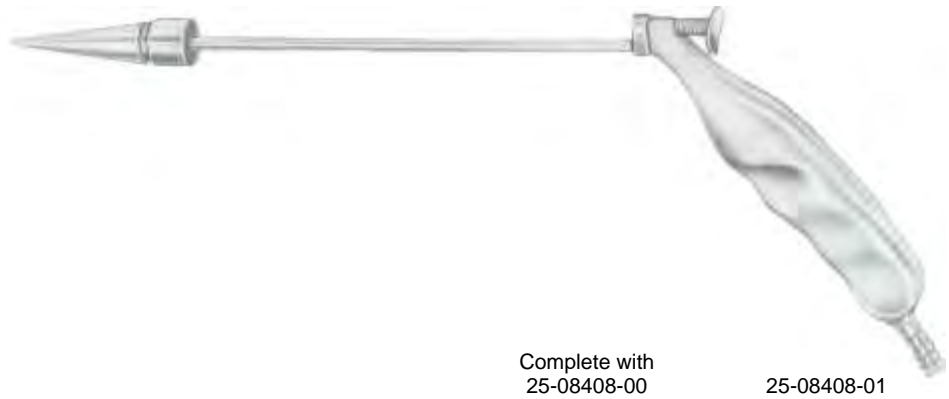

Complete with
25-08408-00

25-08408-01



McGivney
25-08412-19
19 cm/7 1/2"



25-08414-00
Ligator rubber rings
in box of 100 pieces

Atrauma



Guyon



26-08416-20
20 cm/8"

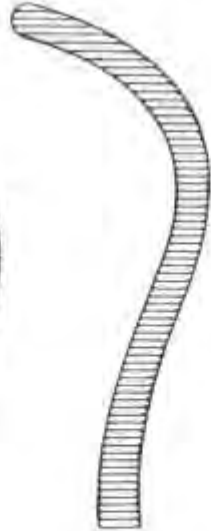

26-08416-22
22 cm/8¾"



26-08416-24
24 cm/9½"



26-08418-23
23 cm/9"



26-08418-24
24 cm/9½"

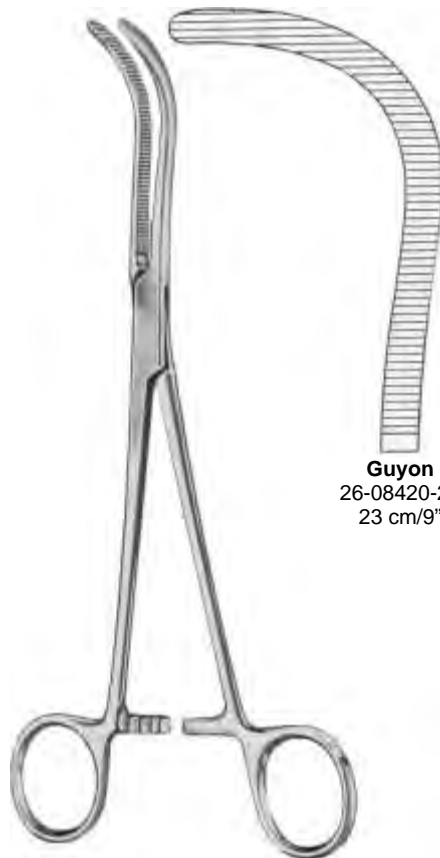

Guyon
26-08420-23
23 cm/9"



Herrick
26-08424-23
23 cm/9"



Mayo-Guyon
26-08428-23
23 cm/9"



Stille
26-08432-23
23 cm/9"



Elsasser
26-08436-20
20 cm/8"



26-08438-20
20 cm/8"



Randall



26-08442-01
19 cm/7 1/2"



26-08442-02
19 cm/7 1/2"



Randall

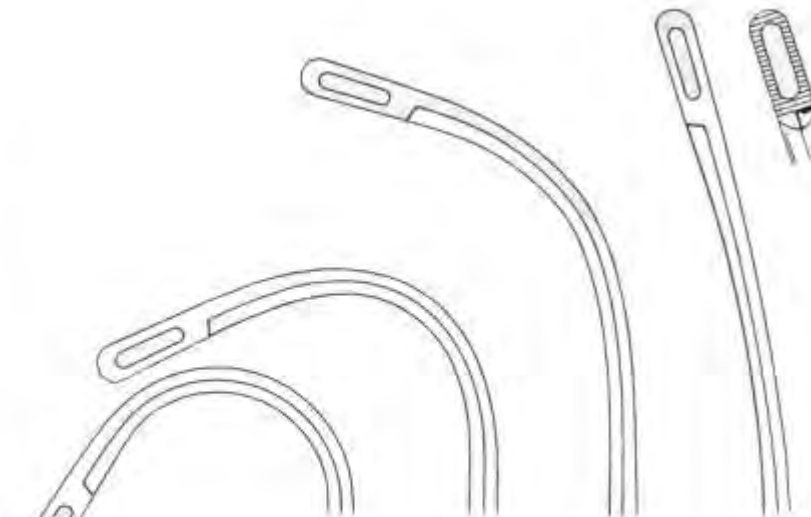

Fig. 4
26-08446-04
22 cm/8 3/4"

Fig. 3
26-08446-03
22 cm/8 3/4"

Fig. 2
26-08446-02
22 cm/8 3/4"

Fig. 1
26-08446-01
23 cm/9"



Gray
26-08450-00

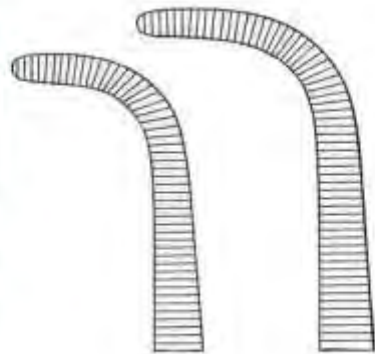

Fig. 1
26-08450-01
22 cm/8¾"

Fig. 2
26-08450-02
23 cm/9"

Set of 2 pieces



Gray
26-08454-00



Fig. 1
26-08454-01
22 cm/8¾"

Fig. 2
26-08454-02
23 cm/9"

Set of 2 pieces

Gall duct and
cystic forceps



Desjardins
26-08458-21
21 cm/8¼"



Nissen
26-08462-21
21.5 cm/8½"



Straight **Blake** Curved
26-08466-20 20 cm/8" 26-08467-20



Straight **Mayo-Blake** Curved
26-08472-20 20 cm/8" 26-08473-20



Czerny
26-08476-24
24.5 cm/9¾"

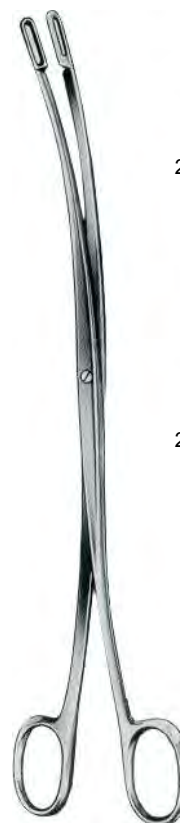

Desjardins
23 cm/9"



Fig. 1
26-08480-01



Fig. 2
26-08480-02

Elastic



Desjardins
28 cm/11"

26-08484-01

26-08484-02

26-08484-03

Bile duct dilators.



Bakes
30 cm/12"

mm	
1	26-08488-01
2	26-08488-02
3	26-08488-03
4	26-08488-04
5	26-08488-05
6	26-08488-06
7	26-08488-07
8	26-08488-08
9	26-08488-09
10	26-08488-10
11	26-08488-11
12	26-08488-12
13	26-08488-13

26-08488-00
set of 9 pieces

26-08488-03 to 26-08488-11

26-08490-00
set of 9 pieces in canvas pocket





Mayo
26-08500-28
28 cm/11"



Mayo
26.5 cm/10½"



Fig. 1
26-08504-01



Fig. 2
26-08504-02



Fig. 3
26-08504-03



Moore
26-08506-28
28 cm/11"

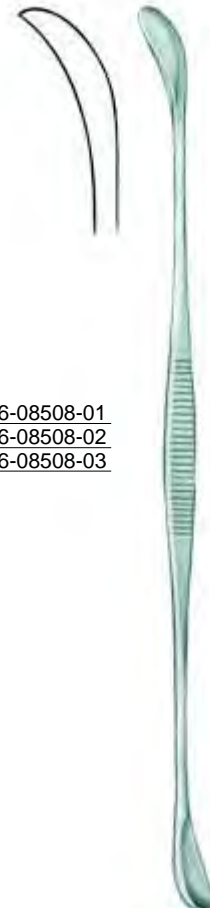
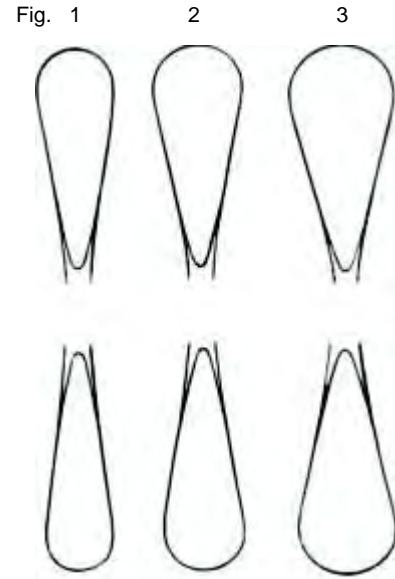

Fergusson
24 cm/9½"

Fig.
1 26-08508-01
2 26-08508-02
3 26-08508-03



Young
26-08510-21
21 cm/8¼"



Young
26-08512-22
22 cm/8¾"



Young
26-08514-21
21 cm/8¼"



Young
26-08514-22
22 cm/8¾"



Millin
26-08516-23
23 cm/9"



Millin
26-08518-23
23 cm/9"



Millin
26-08520-23
23 cm/9"



Millin
26-08522-24
24 cm/9½"

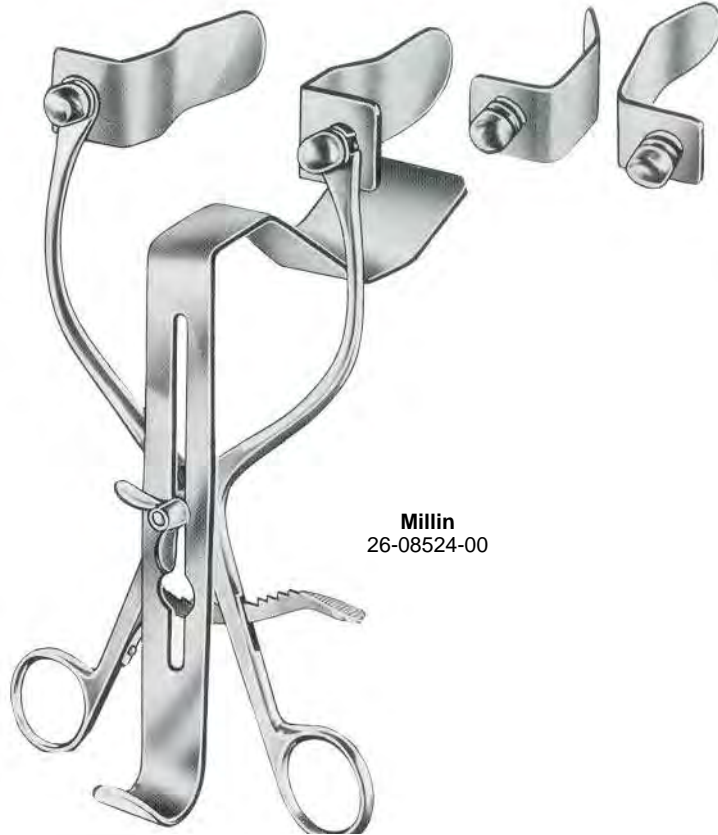

Millin
26-08524-00



Legueu
26-08528-00



Judd-Masson
26-08532-00

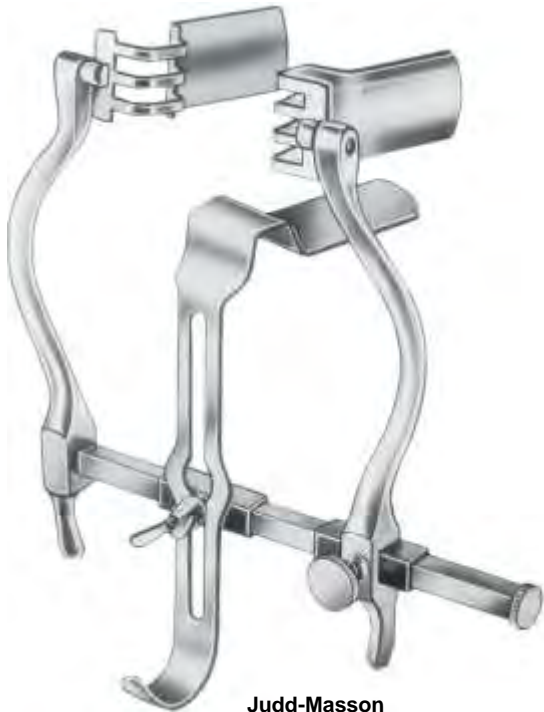

Judd-Masson
26-08536-00



Thomson-Walker
26-08540-00



Legueu
26-08544-27
27 cm/10½"
35 mm



Kocher
26-08548-26
26 cm/10¼"
67 mm

mm Ø	Charriere (French)
2 ² / ₃	8
3	9
3 ¹ / ₃	10
3 ² / ₃	11
4	12
4 ¹ / ₃	13
4 ² / ₃	14
5	15
5 ¹ / ₃	16
5 ² / ₃	17
6	18
6 ¹ / ₃	19
6 ² / ₃	20
7	21
7 ¹ / ₃	22
7 ² / ₃	23
8	24
8 ¹ / ₃	25
8 ² / ₃	26
9	27
9 ¹ / ₃	28
9 ² / ₃	29
10	30
10 ¹ / ₃	32
11 ² / ₃	34
12	36



Van Buren
Charrier (French)
No. 8-36

26-08552-08
26-08552-36
28 cm/11"

In Canvas Pouch
26-08552-50
Set of 6

6 Pcs. 26-08552-14/24
26-08552-24

26-08552-60
Set of 12

12 Pcs 26-08552-08/36
26-08552-36

26-08552-08
26-08552-10
26-08552-12
26-08552-14
26-08552-16
26-08552-18
26-08552-20
26-08552-22
26-08552-24
26-08552-26
26-08552-28
26-08552-30
26-08552-32
26-08552-34
26-08552-36



Dittel
Charriere (French)
No. 8-30

26-08554-08
26-08554-30
19.5 cm/7¹/₂"

Straight

26-08554-08
26-08554-09
26-08554-10
26-08554-11
26-08554-12
26-08554-13
26-08554-14
26-08554-15
26-08554-16
26-08554-17
26-08554-18
26-08554-19
26-08554-20
26-08554-21
26-08554-22
26-08554-23
26-08554-24
26-08554-25
26-08554-26
26-08554-27
26-08554-28
26-08554-29
26-08554-30

Curved

26-08556-08
26-08556-09
26-08556-10
26-08556-11
26-08556-12
26-08556-13
26-08556-14
26-08556-15
26-08556-16
26-08556-17
26-08556-18
26-08556-19
26-08556-20
26-08556-21
26-08556-22
26-08556-23
26-08556-24
26-08556-25
26-08556-26
26-08556-27
26-08556-28
26-08556-29
26-08556-30



Dittel
Charriere (French)
No. 8-30

26-08556-08
26-08556-30
34.5 cm/13¹/₂"

For men



26-08560-06
26-08560-24

	mm Ø	Charriere (French)	
26-08560-06	2	6	26-08562-06
26-08560-07	2 $\frac{1}{3}$	7	26-08562-07
26-08560-08	2 $\frac{2}{3}$	8	26-08562-08
26-08560-09	3	9	26-08562-09
26-08560-10	3 $\frac{1}{3}$	10	26-08562-10
26-08560-11	3 $\frac{2}{3}$	11	26-08562-11
26-08560-12	4	12	26-08562-12
26-08560-13	4 $\frac{1}{3}$	13	26-08562-13
26-08560-14	4 $\frac{2}{3}$	14	26-08562-14
26-08560-15	5	15	26-08562-15
26-08560-16	5 $\frac{1}{3}$	16	26-08562-16
26-08560-17	5 $\frac{2}{3}$	17	26-08562-17
26-08560-18	6	18	26-08562-18
26-08560-19	6 $\frac{1}{3}$	19	26-08562-19
26-08560-20	6 $\frac{2}{3}$	20	26-08562-20
26-08560-21	7	21	26-08562-21
26-08560-22	7 $\frac{1}{3}$	22	26-08562-22
26-08560-23	7 $\frac{2}{3}$	23	26-08562-23
26-08560-24	8	24	26-08562-24

For Women



Catheter Introducing Instruments



Guyon
26-08566-39
39 cm/15 $\frac{1}{2}$ "



Guyon
26-08568-35
35 cm/13 $\frac{3}{4}$ "

Circumcision Instruments



26-08572-08	08 mm
26-08572-11	11 mm
26-08572-13	13 mm
26-08572-16	16 mm
26-08572-21	21 mm
26-08572-26	26 mm
26-08572-32	32 mm

Foreign Body Forceps



Mathieu
26-08584-20

Penis Clamps

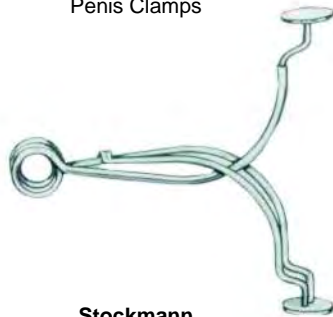

Stockmann
26-08576-00



Strauss
26-08580-00

Secretion Scoop



Guttman
26-08588-26
26.5 cm/10½"

Scheme of Dimensions for Specula

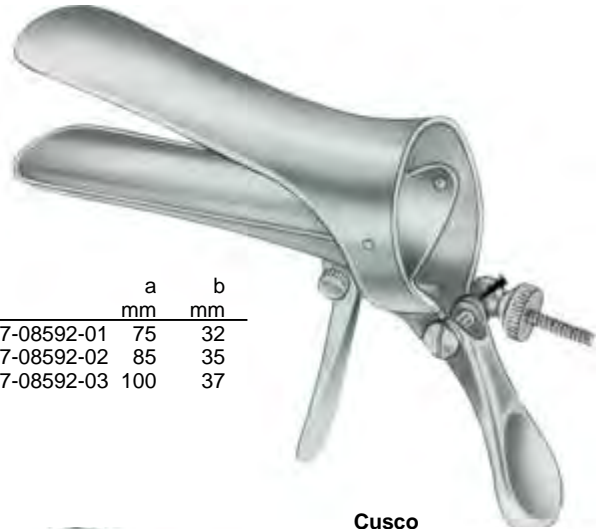
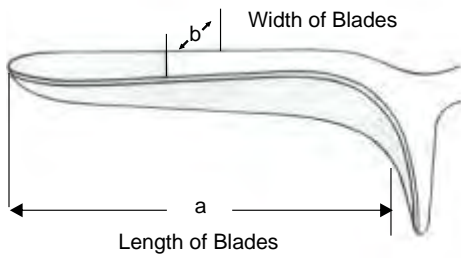

	a mm	b mm
27-08592-01	75	32
27-08592-02	85	35
27-08592-03	100	37

Cusco

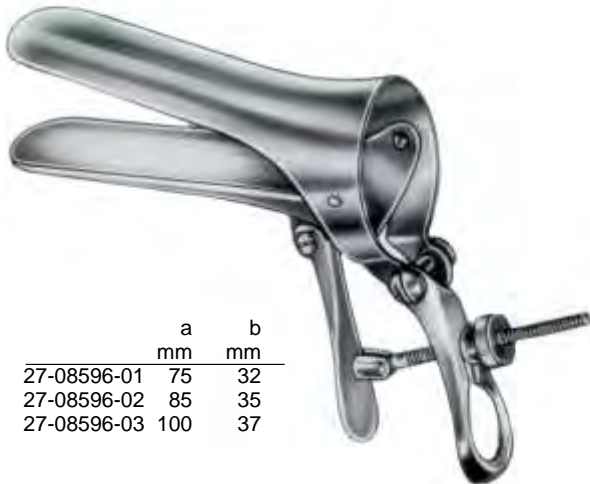

	a mm	b mm
27-08596-01	75	32
27-08596-02	85	35
27-08596-03	100	37

Cusco



For Virgins	a mm	b mm
27-08600-00	75	17

Cusco



For Virgins	a mm	b mm
27-08604-00	75	17

Cusco



	a mm	b mm
27-08608-01	90	23-25
27-08608-02	100	25-27
27-08608-03	110	27-30

**Cusco
Swiss Pattern**



Collin-Landau

	a	b
	mm	mm
27-08612-01	85	30
27-08612-02	100	35
27-08612-03	110	40



Collin

	a	b
	mm	mm
27-08616-01	85	30
27-08616-02	100	35
27-08616-03	110	40



Trelat

	a	b
	mm	mm
27-08620-01	85	33
27-08620-02	95	35
27-08620-03	115	43



Grave (Standard)

	a	b
	mm	mm
27-08624-01	75	20
27-08624-02	95	30
27-08624-03	115	35
27-08624-04	125	35

Insulated

Black



Grave	a mm	b mm
27-08628-01	75	20
27-08628-02	95	30
27-08628-03	115	35



Grave	a mm	b mm
Angled 135° 27-08632-00	101	35

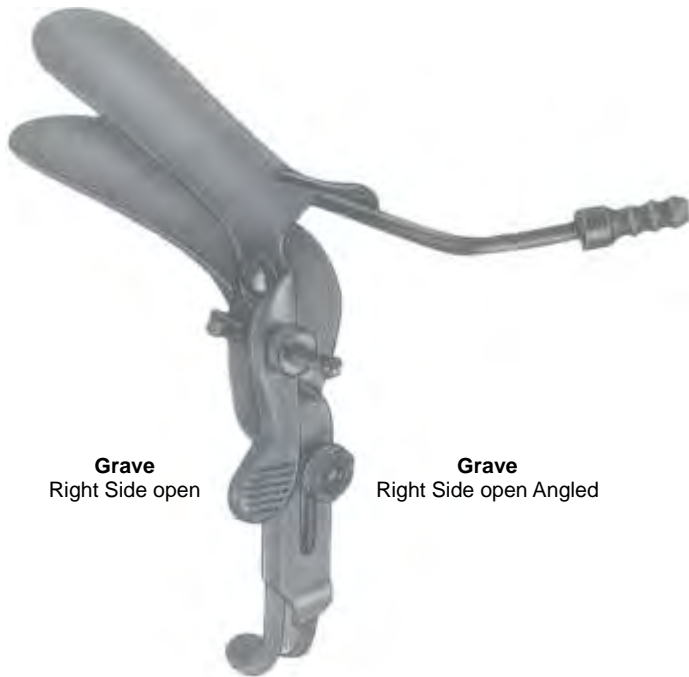

Grave
Right Side open

Grave
Right Side open Angled

	a mm	b mm
27-08636-01	101	35
27-08636-02	101	35

Lateral Specula



27-08640-00



Pederson

	a mm	b mm
27-08644-01	75	13
27-08644-02	100	22
27-08644-03	120	25

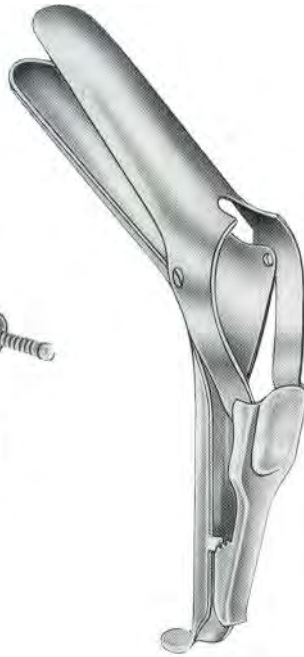

Semm

	a mm	b mm
27-08648-01	90	14/18
27-08648-02	100	17/20
27-08648-03	100	25/30

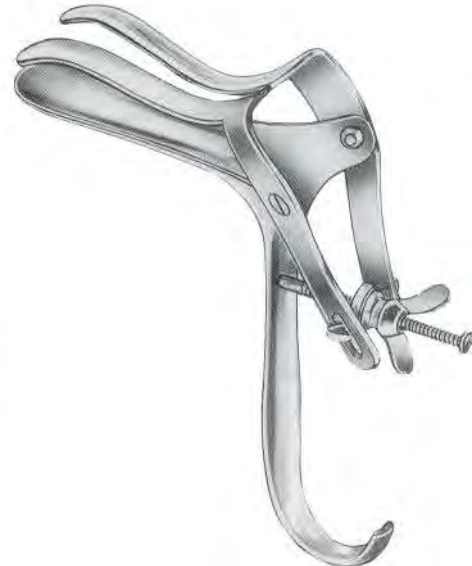

Nott

	a mm	b mm
27-08652-01	90	30
27-08652-02	110	30



Seyffert

	a mm	b mm
27-08656-01	100	17
27-08656-02	110	33



Seyffert

	a mm	b mm
27-08658-02	110	33

One Side open

Scheme of Dimensions for Specula

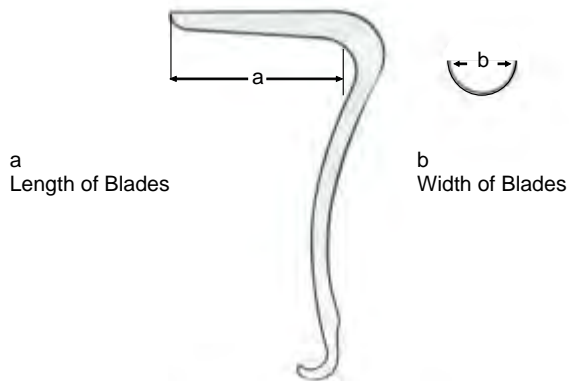

Sims
27-08662-01 63 x 32 mm
27-08662-02 76 x 32 mm
27-08662-03 89 x 38 mm



Sims

	Fig	a mm	b mm
27-08666-01	1	60	25+30
27-08666-02	2	70	30+35
27-08666-03	3	80	35+40



Jackson

	Fig.	a mm	b mm
27-08670-01	1	75 X 40	
27-08670-02	2	90 X 40	
27-08670-03	3	100 X 40	



Eastman

	Fig.	a mm	b mm
27-08674-01	1	76	38
27-08674-02	2	89	38
27-08674-03	3	101	38

For children



Set

Kristeller
27-08678-00
70x15 mm



Specula

Retractor

Kristeller
(Standard)

Set of 1 specula and 1 retractor

Fig. 1 27-08682-00

Fig. 2 27-08684-00

Fig. 3 27-08686-00

Specula

	Fig.	a mm	b mm
27-08682-01	1	70	27
27-07684-01	2	75	30
27-07686-01	3	90	36

Retractors

	Fig.	a mm	b mm
27-08682-02	1	75	23
27-07684-02	2	80	26
27-07686-02	3	95	32



With conically shaped blades for virgins

Kristeller

Set of 1 specula and 1 retractor

Fig. 00 27-08690-00

Fig. 0 27-08692-00

Specula

	Fig.	a		b	
		mm	mm	mm	mm
27-08690-01	00	110	18		
27-08692-01	0	110	21		

Retractors

	Fig.	a		b	
		mm	mm	mm	mm
27-08690-02	00	115	14		
27-08692-02	0	115	17		



With extra long blades

**Kristeller
(Standard)**

Set of 1 specula and 1 retractor

Fig. 1 27-08696-00

Fig. 2 27-08698-00

Fig. 3 27-08700-00

Specula

	Fig.	a		b	
		mm	mm	mm	mm
27-08696-01	1	110	27		
27-08698-01	2	110	30		
27-08700-01	3	110	36		

Retractors

	Fig.	a		b	
		mm	mm	mm	mm
27-08696-02	1	115	23		
27-08698-02	2	115	26		
27-08700-02	3	115	32		



Set of 1 specula and 1 retractor

Fig. 1 27-08704-00

Fig. 2 27-08706-00

Fig. 3 27-08708-00

Specula

	Fig.	a	b
		mm	mm
27-08704-01	1	110	27
27-08706-01	2	110	30
27-08708-01	3	110	36

Retractors

	Fig.	a	b
		mm	mm
27-08704-02	1	115	23
27-08706-02	2	115	26
27-08708-02	3	115	32

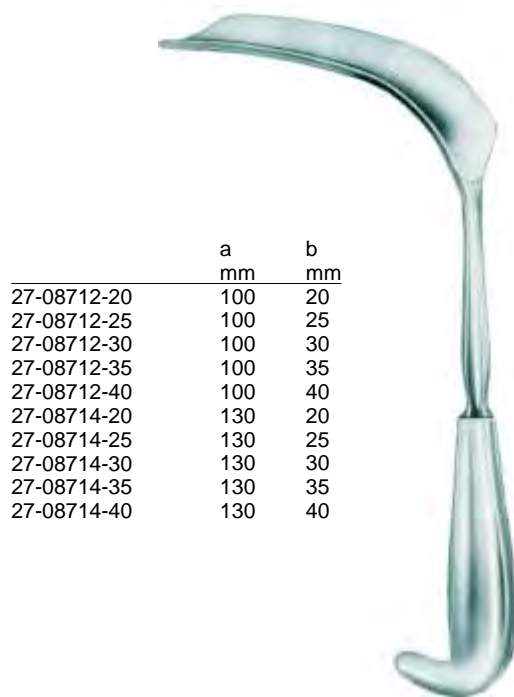

	a	b
	mm	mm
27-08712-20	100	20
27-08712-25	100	25
27-08712-30	100	30
27-08712-35	100	35
27-08712-40	100	40
27-08714-20	130	20
27-08714-25	130	25
27-08714-30	130	30
27-08714-35	130	35
27-08714-40	130	40

Matzenauer



Braun
27-08718-18
18 cm/7"
56x13 mm



Braun
27-08722-18
18 cm/7"
60x10 mm



Ulrich
27-08726-19
19.5 cm/7½"
80x20 mm



27-08730-19
19 cm/7½"
85x17 mm



Set

27-08734-00	Fig. 1
27-08736-00	Fig. 2

Specula

	Fig.	a	b
		mm	mm
27-08734-01	1	70	40
27-08736-01	2	90	40

Retractors

	Fig.	a	b
		mm	mm
27-08734-02	1	70	33
27-08736-02	2	90	33

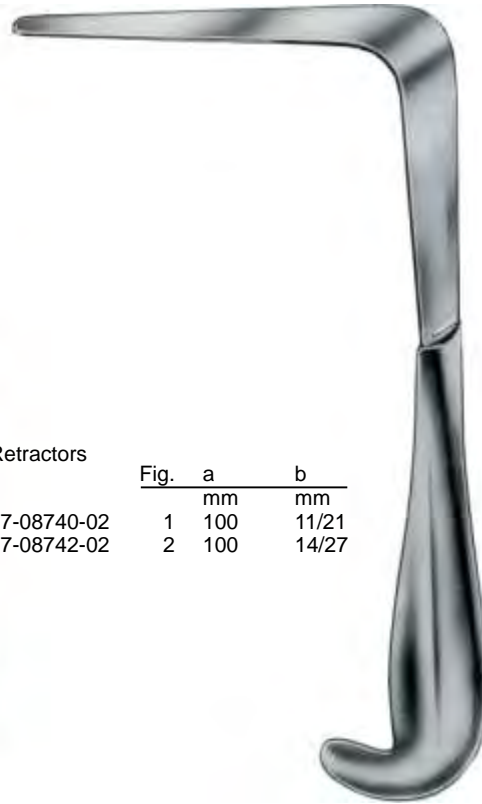
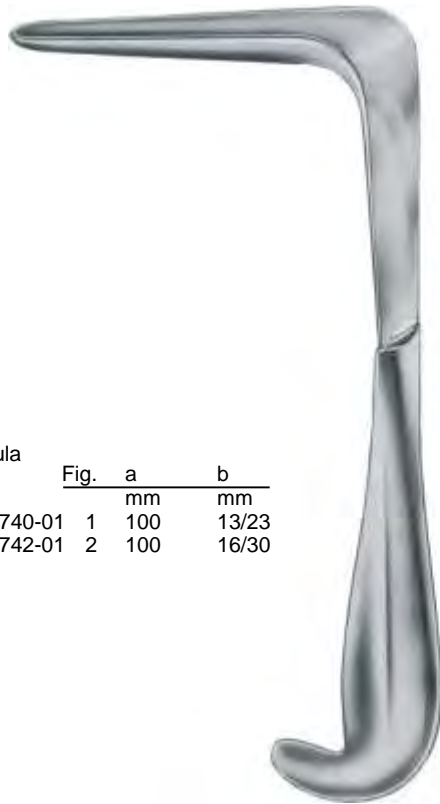

Specula	Fig.	a		b	
		mm	mm	mm	mm
27-08740-01	1	100	13/23		
27-08742-01	2	100	16/30		

Retractors	Fig.	a		b	
		mm	mm	mm	mm
27-08740-02	1	100	11/21		
27-08742-02	2	100	14/27		

Set	Fig.	a		b	
		mm	mm	mm	mm
27-08740-00	1				
27-08742-00	2				

Mathieu

Mathieu

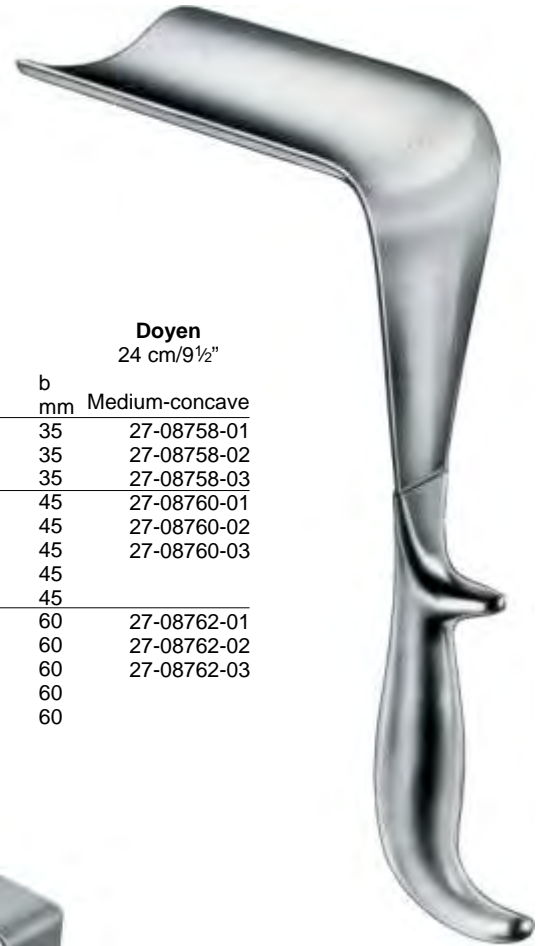

	Fig.	a		b	
		mm	mm	mm	mm
27-08746-01	1	75	45		
27-08746-02	2	90	45		
27-08746-03	3	110	45		

Doyen



Doyen 24 cm/9½"		Fig.	a mm	b mm	Doyen 24 cm/9½"	
slightly-concave					Medium-concave	
27-08750-01	1	55	35	27-08758-01		
27-08750-02	2	85	35	27-08758-02		
27-08750-03	3	115	35	27-08758-03		
27-08752-01	1	55	45	27-08760-01		
27-08752-02	2	85	45	27-08760-02		
27-08752-03	3	115	45	27-08760-03		
27-08752-04	4	160	45			
27-08752-05	5	180	45			
27-08754-01	1	55	60	27-08762-01		
27-08754-02	2	85	60	27-08762-02		
27-08754-03	3	115	60	27-08762-03		
27-08754-04	4	160	60			
27-08754-05	5	180	60			



Doyen
25 cm/10"

	a mm	b mm
27-08766-01	60	30
27-08766-02	70	30
27-08766-03	80	30





Auvard
with removable weight
27-08770-01
80x38 mm
27-08770-02
105x42 mm



Auvard
with fixed weight
27-08772-01
70x38 mm
27-08772-02
102x45 mm



Landau

	a mm	b mm
27-08776-01	100	28
27-08776-02	100	38



Breisky

	a mm	b mm
27-08780-20	100	20
27-08780-25	100	25
27-08780-30	100	30
27-08780-35	100	35
27-08780-40	100	40
27-08782-20	130	20
27-08782-25	130	25
27-08782-30	130	30
27-08782-35	130	35
27-08782-40	130	40
27-08784-20	160	20
27-08784-25	160	25
27-08784-30	160	30
27-08784-35	160	35
27-08784-40	160	40
27-08786-20	180	20
27-08786-25	180	25
27-08786-30	180	30
27-08786-35	180	35
27-08786-40	180	40



Scherbak
27-08790-00

Complete



27-08790-01
80x30 mm



27-08790-02
85x35 mm



27-08790-03
90x40 mm



27-08790-04
55x40/60 mm



27-08790-05
70x45/70 mm



	Fig.	a mm	b mm
27-08794-01	1	45	17
27-08794-02	2	90	37
27-08794-03	3	90	45



O'Sullivan-O'Connor
27-08794-00
Complete



Hegar

mm \varnothing		mm \varnothing	
1.0	27-08798-01	1.5	27-08800-01
2.0	27-08798-02	2.5	27-08800-02
3.0	27-08798-03	3.5	27-08800-03
4.0	27-08798-04	4.5	27-08800-04
5.0	27-08798-05	5.5	27-08800-05
6.0	27-08798-06	6.5	27-08800-06
7.0	27-08798-07	7.5	27-08800-07
8.0	27-08798-08	8.5	27-08800-08
9.0	27-08798-09	9.5	27-08800-09
10.0	27-08798-10	10.5	27-08800-10
11.0	27-08798-11	11.5	27-08800-11
12.0	27-08798-12	12.5	27-08800-12
13.0	27-08798-13	13.5	27-08800-13
14.0	27-08798-14	14.5	27-08800-14
15.0	27-08798-15	15.5	27-08800-15
16.0	27-08798-16	16.5	27-08800-16
17.0	27-08798-17	17.5	27-08800-17
18.0	27-08798-18	18.5	27-08800-18
19.0	27-08798-19	19.5	27-08800-19
20.0	27-08798-20		
21.0	27-08798-21		
22.0	27-08798-22		
23.0	27-08798-23		
24.0	27-08798-24		
25.0	27-08798-25		
26.0	27-08798-26		
27.0	27-08798-27		
28.0	27-08798-28		
29.0	27-08798-29		
30.0	27-08798-30		

Pieces per set		set
27-08798-50	14	4.0-17.0 mm
27-08798-60	26	1.0-26.0 mm



Hegar

\varnothing mm	
1.0/2.0	27-08804-02
3.0/4.0	27-08804-04
5.0/6.0	27-08804-06
7.0/8.0	27-08804-08
9.0/10.0	27-08804-10
11.0/12.0	27-08804-12
13.0/14.0	27-08804-14
15.0/16.0	27-08804-16
17.0/18.0	27-08804-18
19.0/20.0	27-08804-20
21.0/22.0	27-08804-22
23.0/24.0	27-08804-24
25.0/26.0	27-08804-26

Pieces per set		set
27-08804-00	08	3.0/4.0-17.0/18.0 mm
27-08806-00	13	1.0/2.0-25.0/26.0 mm



Hank
27-08810-00

Fig.	mm	
9/10	4.5/5	27-08810-10
11/12	5.5/6	27-08810-12
13/14	6.5/7	27-08810-14
15/16	7.5/8	27-08810-16
17/18	8.5/9	27-08810-18
19/20	9.5/10	27-08810-20



Set
27-08810-00



Pratt

Fig.	mm	
13/15	4.5/5.0	27-08816-15
17/19	5.6/6.3	27-08816-19
21/23	7.0/7.6	27-08816-23
25/27	8.3/9.0	27-08816-27
29/31	9.6/10.3	27-08816-31
33/35	11.0/11.6	27-08816-35
37/39	12.3/13.0	27-08816-39
41/43	13.6/14.3	27-08816-43

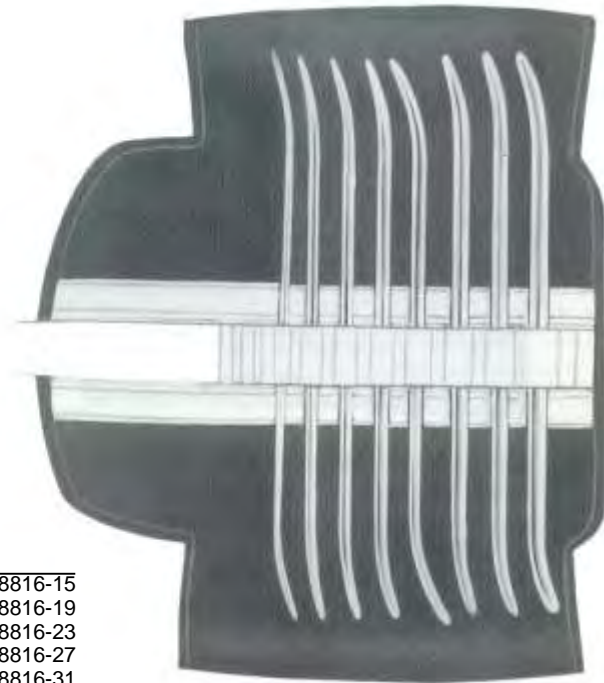

Set
27-08816-00



Goodell
27-08820-34
34 cm/13½"

Black Insulated



Kogan-Laser
28 cm/11"



27-08822-28



27-08824-28



27-08826-28
28 cm/11"



Kogan
27-08830-24
24 cm/9½"

Kogan
27-08832-24
24 cm/9½"

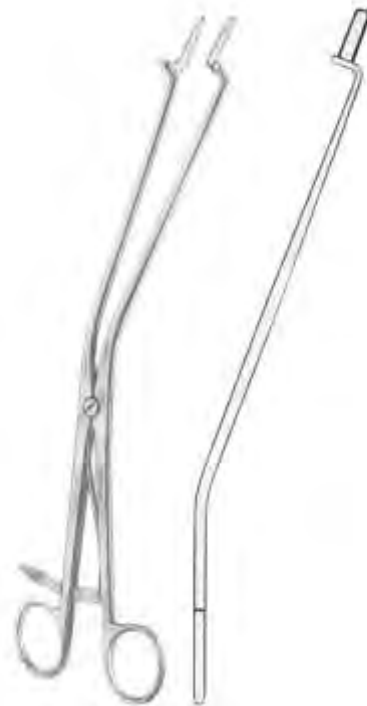

Kogan
28 cm/11"



27-08836-28



27-08838-28

Uterine Depressor



Sims
32 cm/12½"



Martin (Simpson)
32 cm/12½"



Valleix
27-08858-25
25 cm/10"



Collin
27-08862-28
28 cm/11"



Braun
27-08866-28
28 cm/11"

Rigid	cm	cm
	27-08842-32	27-08850-32

Malleable	cm / in	cm / in
	27-08844-32	27-08852-32
	27-08846-32	27-08854-32

Laser Probes



27-08870-01



90°

27-08870-02



45°

27-08870-03



20°

Measuring Probe



27-08872-01

Laser Probe



27-08874-01



90°

27-08874-02



45°

27-08874-03



20°

Depth Ruler



27-08876-01

Measuring Instruments

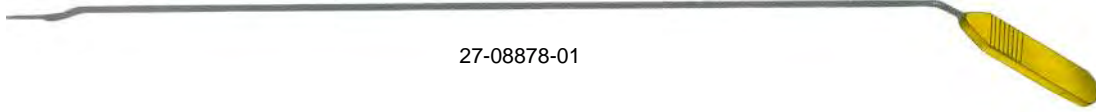

27-08878-01

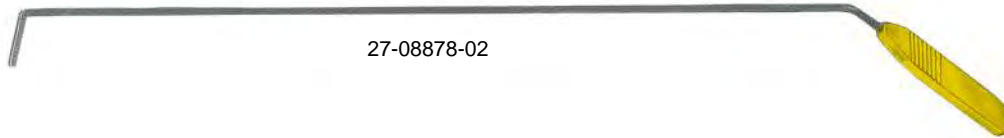

27-08878-02

Hooks



27-08880-01



27-08880-02 Emmet



27-08880-03



27-08882-01



27-08882-02



Martin
27-08886-27
27 cm/10½"



Staude-Moore
27-08890-17
17 cm/6¾"



Barrett
27-08894-18
18 cm/7"



Schroeder
27-08898-25
25 cm/10"



Braun
27-08902-25
25 cm/10"



Collin-Pozzi
27-08906-25
25 cm/10"



Pozzi
27-08910-25
25.5 cm/10¼"

Strong Pattern

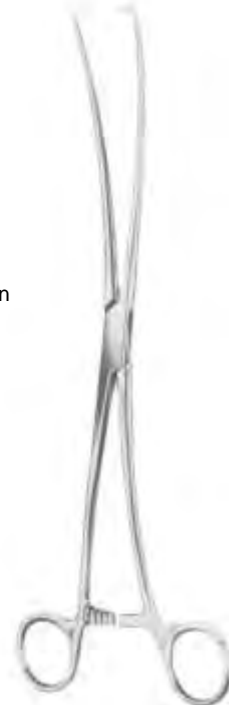

Duplay
27-08914-28
28 cm/11"



Skene
27-08918-24
24 cm/9½"



Amniotome for the amnion Bladder

Beacham
27-08922-26
26 cm/10¼"



Czerny
27-08926-20
20.5 cm/8¼"



27-08930-26
26 cm/10¼"



Schroeder
27-08934-20 20 cm/8"
27-08934-24 24 cm/9½"

Straight



Schroeder
27-08936-20
27-08936-24

Curved on Flat



Schroeder
27-08938-20
27-08938-24

Curved Sideway

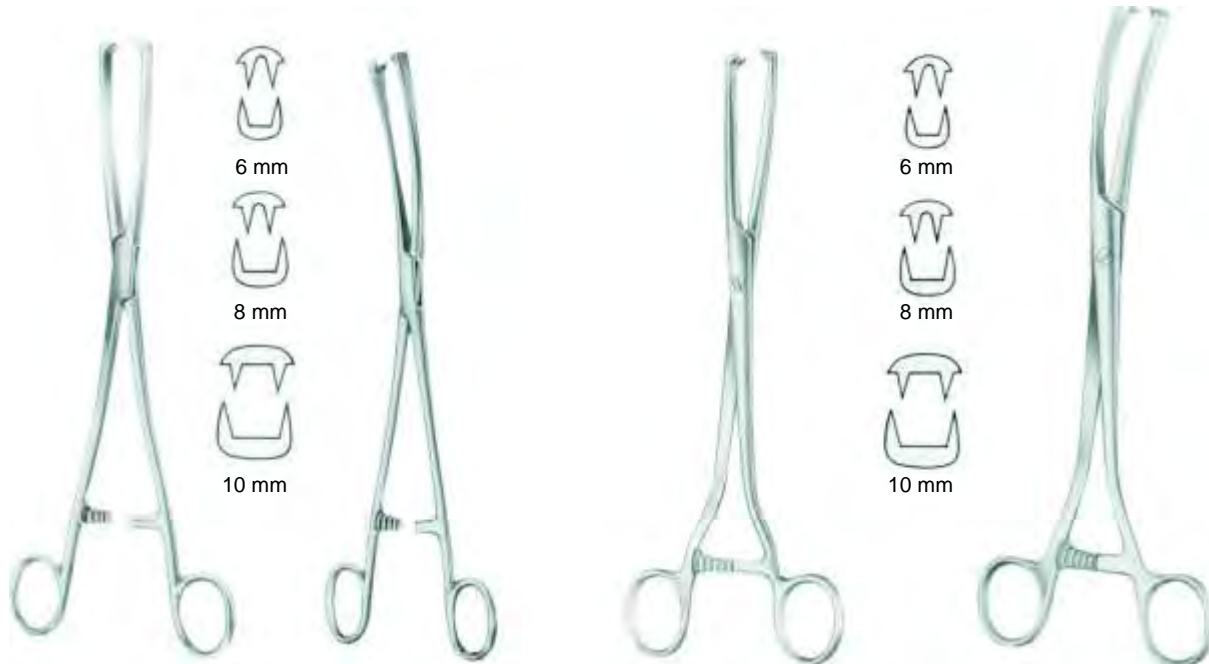

Straight
27-08942-06
27-08942-08
27-08942-10

Museux
24 cm/9½"
06 mm
08 mm
10 mm

Curved Sideway
27-08944-06
27-08944-08
27-08944-10

Straight
27-08948-06
27-08948-08
27-08948-10

Museux
24 cm/9½"
06 mm
08 mm
10 mm

Curved Sideway
27-08952-06
27-08952-08
27-08952-10



Braun
27-08956-16
16 cm/6¼"



Pratt
27-08960-28
28 cm/11"



Teale
27-08964-24
24 cm/9½"



For the amnion Bladder

Iowa
27-08968-26
26 cm/10¼"



Jacobs
Straight 27-08972-21 21 cm/8¼"
Curved Sideway 27-08974-21



Kelly
27-08978-32
32 cm/12½"



Heywood-Smith
27-08982-20
20 cm/8"



Heywood-Smith
27-08986-25
25 cm/10"



Noto
27-08990-27
27 cm/10½"



Dartigues
27-08994-27
27 cm/10½"



Somer
27-08998-23
23 cm/9"



Collin
27-09002-25
25 cm/10"



Doyen
27-09006-18 18 cm/7"
27-09006-20 20 cm/8"

Ovarian Forceps



Ayre
27-09010-23
23 cm/9"



Simon
27-09014-22
22 cm/8¾"



Simon
27-09016-22
22 cm/8¾"



Emmet
22 cm/8¾"



27-09020-01



27-09020-02



27-09020-03



27-09020-04



27-09020-05



Doyen
27-09024-17
17 cm/6¾"



Doyen
27-09026-17
17 cm/6¾"



Segond
27-09030-27
27 cm/10½"

Secretion Spoon



27-09034-27
27 cm/10½"



Muenchen
27 cm/10½"



27-09038-04
4 mm



27-09038-05
5 mm



Randall
27-09042-24
24 cm/9½"

4 mmØ



Novak
23 cm/9"

- 27-09046-01
1 mm
- 27-09046-02
2 mm
- 27-09046-03
3 mm
- 27-09046-04
4 mm



Novak-Schoeckaert
27-09050-24
24 cm/9"



Kevorkian malleable
27-09054-30 27-09056-30
30 cm/12" 30 cm/12"



Kevorkian malleable
27-09060-30 27-09062-30
30 cm/12" 30 cm/12"



Townsend malleable
27-09066-30 27-09068-30
31 cm/12¼" 31 cm/12¼"



Duncan
27-09072-31
31 cm/12¼"



Duncan
27-09074-31
31 cm/12¼"



Gellhorn
27-09078-23
23 cm/9"



Thoms-Gaylor
27-09082-24
24 cm/9½"



Schubert
27-09086-21 21 cm/8¼"
27-09086-29 29 cm/11¼"



Schubert
27-09090-26
26 cm/10¼"



Tischler
27-09094-27
27 cm/10½"



Van Doren
27-09098-25
25 cm/10"



Fig.1

Fig.2

Schumacher

Fig. 1 27-09102-01 24 cm/9½"

Fig. 2 27-09102-02 24 cm/9½"



Faure

27-09106-21
21 cm/8¼"

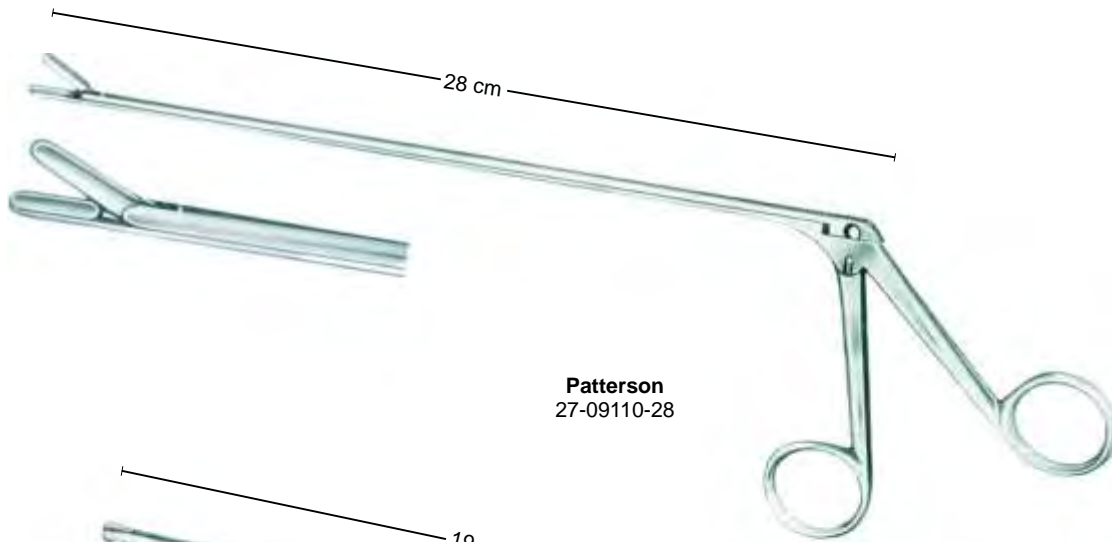

28 cm

Patterson
27-09110-28

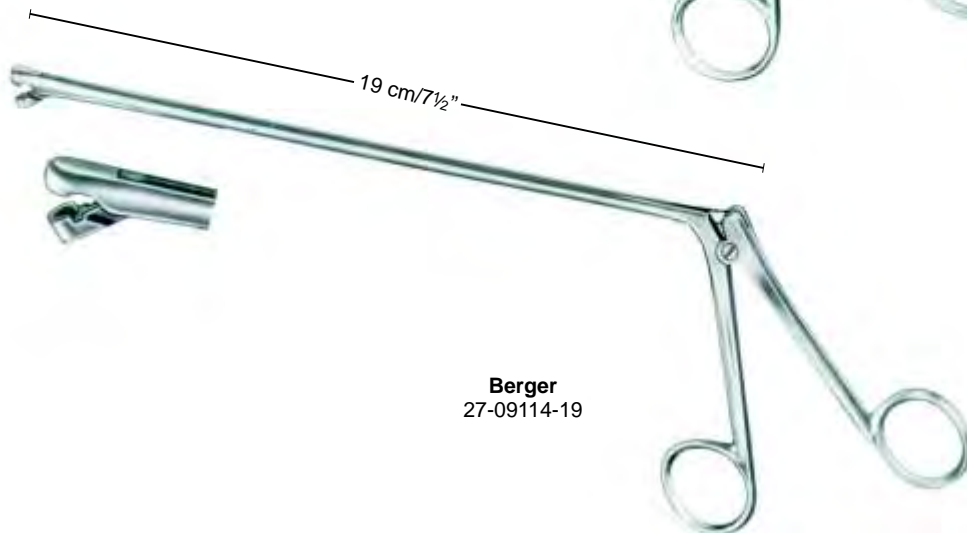

19 cm/7½"

Berger
27-09114-19



- 27-09118-20 L= 20 cm/8"
- 27-09118-25 L= 25 cm/10"
- 27-09118-30 L= 30 cm/12"
- 27-09118-35 L= 35 cm/14"
- 27-09118-40 L= 40 cm/16"



Douay



L = 24 cm/9½"

Schumacher

- 27-09124-04 4 mm
- 27-09124-06 6 mm



L = 24 cm/9½"

Kevorkian

27-09128-24

L = 20 cm/8"



Eppendorf

27-09122-20

L = 23 cm/9"



Wittner

27-09126-23

L = 23 cm/9"



Wittner

27-09130-23

Gynecology Instruments Cervical Biopsy and Specimen Forceps

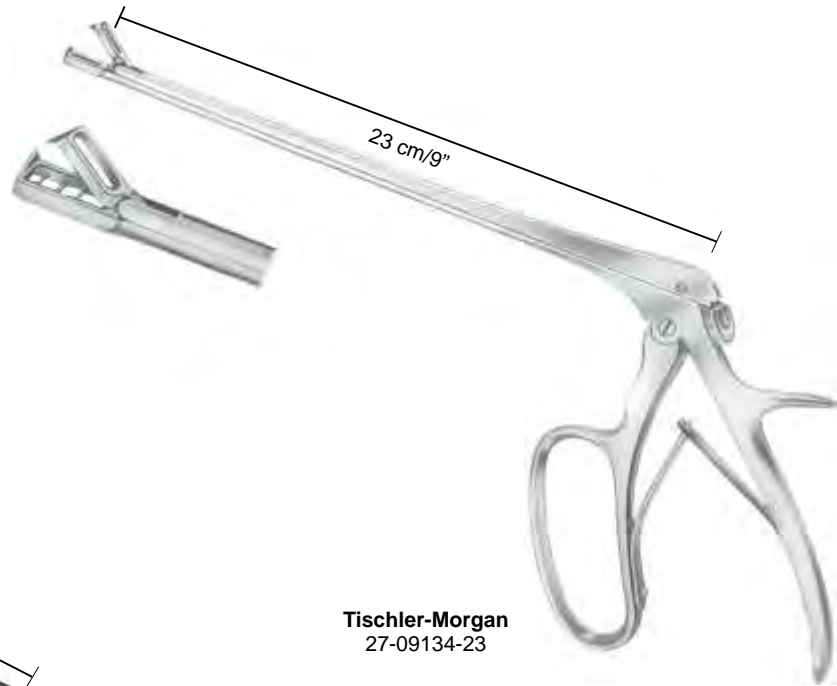

Tischler-Morgan
27-09134-23



Baby-Tischler
27-09136-21



Alexander
27-09140-28



Pacific-Kevorkian
27-09144-24



Burke
27-09148-23











Handle

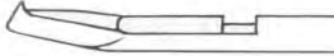

Tip with tube

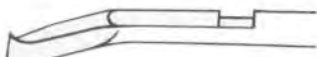
Townsend

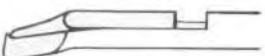
		Complete instrument	Tip, only
	Tischier	27-09152-00	27-09152-01
	Kevorkian	27-09154-00	27-09154-01
	Mini-Townsend	27-09156-00	27-09156-01
	 Tischler-up	27-09158-00	27-09158-01
	 Tischler-down	27-09160-00	27-09160-01
	Mini-Townsend-up	27-09162-00	27-09162-01
	 Mini-Townsend-down	27-09164-00	27-09164-01



Schroeder
30 cm/12"

Sharp Rigid



Fig. 1
27-09168-01
27-09170-01



Fig. 2
27-09168-02
27-09170-02



Fig. 3
27-09168-03
27-09170-03

Schroeder
Simon



Fig. 4
27-09168-04
27-09170-04



Fig. 5
27-09168-05
27-09170-05



Fig. 6
27-09168-06
27-09170-06

Schroeder
Simon



Simon
25 cm/10"



Fig. 1
27-09174-01
6 mm



Fig. 2
27-09174-02
8 mm



Fig. 3
27-09174-03
10 mm



Gourdet
28 cm/11"



Fig. 4
27-09174-04
12 mm



Fig. 5
27-09174-05
14 mm



Thomas



Fig. 1
27-09177-01



Fig. 2
27-09177-02



Fig. 3
27-09177-03



Fig. 4
27-09177-04



Fig. 5
27-09177-05



Fig. 6
27-09177-06



Greene

27-09180-10
10 mm

27-09180-12
12 mm

27-09180-14
14 mm



Collin
27-09184-30
30 cm/12"



Heaney
27-09188-24
24 cm/9½"



Heaney
27-09192-24
24 cm/9½"



Milan
28.5 cm/11¼"

Malleable

27-09196-05
5 mm Ø

27-09196-07
7 mm Ø

27-09196-09
9 mm Ø

Rigid

27-09198-05
5 mm Ø

27-09198-07
7 mm Ø

27-09198-09
9 mm Ø



28 cm/11"

Hose Connecting Piece



27-09206-00

- | | |
|-------------|---------|
| | Ø |
| 27-09202-04 | 4.0 mm |
| 27-09202-06 | 6.0 mm |
| 27-09202-08 | 8.0 mm |
| 27-09202-10 | 10.0 mm |
| 27-09202-12 | 12.0 mm |
| 27-09202-14 | 14.0 mm |
| 27-09202-16 | 16.0 mm |



Sims
25 cm/10"



Fig. 1 7.5 mm Fig. 2 8.5 mm Fig. 3 10 mm Fig. 4 11.5 mm Fig. 5 13.5 mm Fig. 6 14.5 mm

Malleable		Rigid	
Sharp	Blunt	Sharp	Blunt

Fig. 1	27-09210-01	27-09211-01	27-09214-01	27-09215-01
Fig. 2	27-09210-02	27-09211-02	27-09214-02	27-09215-02
Fig. 3	27-09210-03	27-09211-03	27-09214-03	27-09215-03
Fig. 4	27-09210-04	27-09211-04	27-09214-04	27-09215-04
Fig. 5	27-09210-05	27-09211-05	27-09214-05	27-09215-05
Fig. 6	27-09210-06	27-09211-06	27-09214-06	27-09215-06



Sims
25 cm/10"



Fig. 1 7.5 mm Fig. 2 8.5 mm Fig. 3 10 mm Fig. 4 11.5 mm Fig. 5 13.5 mm Fig. 6 14.5 mm

Malleable		Rigid	
Sharp	Blunt	Sharp	Blunt

Fig. 1	27-09218-01	27-09219-01	27-09222-01	27-09223-01
Fig. 2	27-09218-02	27-09219-02	27-09222-02	27-09223-02
Fig. 3	27-09218-03	27-09219-03	27-09222-03	27-09223-03
Fig. 4	27-09218-04	27-09219-04	27-09222-04	27-09223-04
Fig. 5	27-09218-05	27-09219-05	27-09222-05	27-09223-05
Fig. 6	27-09218-06	27-09219-06	27-09222-06	27-09223-06

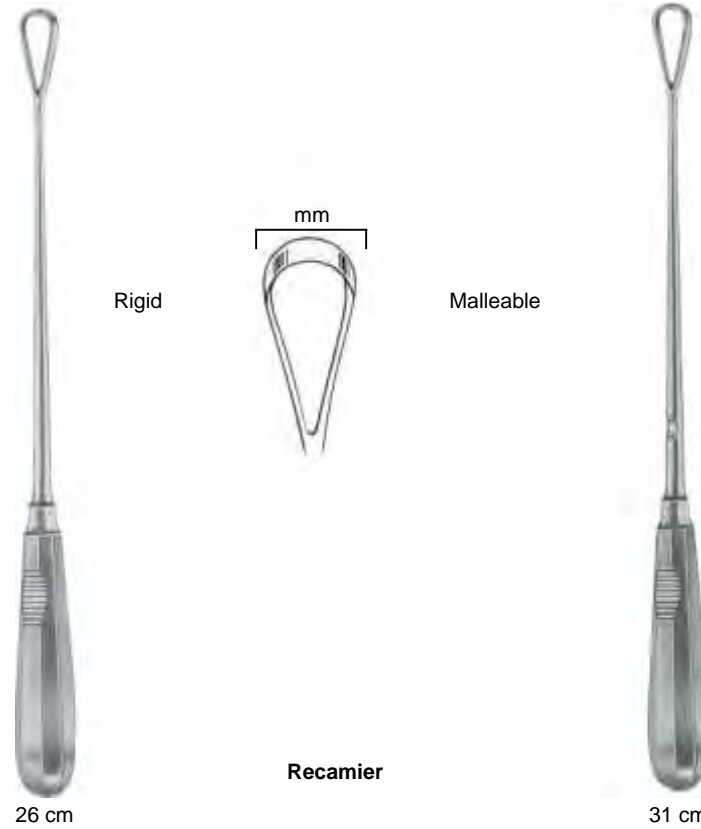

Fig.	mm	Malleable		Rigid		Malleable		Rigid	
		Sharp	Blunt	Sharp	Blunt	Sharp	Blunt	Sharp	Blunt
00	5	27-09226-05	27-09227-05	27-09228-05	27-09229-05	27-09230-05	27-09231-05	27-09232-05	27-09233-05
0	6	27-09226-06	27-09227-06	27-09228-06	27-09229-06	27-09230-06	27-09231-06	27-09232-06	27-09233-06
1	7	27-09226-07	27-09227-07	27-09228-07	27-09229-07	27-09230-07	27-09231-07	27-09232-07	27-09233-07
2	8	27-09226-08	27-09227-08	27-09228-08	27-09229-08	27-09230-08	27-09231-08	27-09232-08	27-09233-08
3	9	27-09226-09	27-09227-09	27-09228-09	27-09229-09	27-09230-09	27-09231-09	27-09232-09	27-09233-09
4	10	27-09226-11	27-09227-11	27-09228-11	27-09229-11	27-09230-11	27-09231-11	27-09232-11	27-09233-11
5	12	27-09226-12	27-09227-12	27-09228-12	27-09229-12	27-09230-12	27-09231-12	27-09232-12	27-09233-12
6	14	27-09226-14	27-09227-14	27-09228-14	27-09229-14	27-09230-14	27-09231-14	27-09232-14	27-09233-14
7	15	27-09226-15	27-09227-15	27-09228-15	27-09229-15	27-09230-15	27-09231-15	27-09232-15	27-09233-15
8	16	27-09226-16	27-09227-16	27-09228-16	27-09229-16	27-09230-16	27-09231-16	27-09232-16	27-09233-16
9	19	27-09226-19	27-09227-19	27-09228-19	27-09229-19	27-09230-19	27-09231-19	27-09232-19	27-09233-19
10	20	27-09226-20	27-09227-20	27-09228-20	27-09229-20	27-09230-20	27-09231-20	27-09232-20	27-09233-20
11	21	27-09226-21	27-09227-21	27-09228-21	27-09229-21	27-09230-21	27-09231-21	27-09232-21	27-09233-21
12	23	27-09226-23	27-09227-23	27-09228-23	27-09229-23	27-09230-23	27-09231-23	27-09232-23	27-09233-23
13	25					27-09230-25	27-09231-25	27-09232-25	27-09233-25
14	30					27-09230-30	27-09231-30	27-09232-30	27-09233-30
15	35					27-09230-35	27-09231-35	27-09232-35	27-09233-35
16	40					27-09230-40	27-09231-40	27-09232-40	27-09233-40



Bumm
max. 29 cm/11½"

Fig.	mm	Mealleable	
		Sharp	Blunt
0	16.0	27-09236-16	27-09237-16
1	18.0	27-09236-18	27-09237-18
2	19.5	27-09236-19	27-09237-19
3	21.5	27-09236-21	27-09237-21
4	23.5	27-09236-23	27-09237-23
5	26.0	27-09236-26	27-09237-26
6	28.5	27-09236-28	27-09237-28



Blunt

Sharp

Blake (Zweifel)
27-09240-27 27 cm/10½"
27-09240-31 31 cm/12¼"

For Internal Measurements



28-09244-45
Laparotomy Ring
1¾" Inside Diameter



De Lee
28-09248-20
20 cm/8"
cm/Inch Scale



Martin
28-09252-34 34 cm/13½" 28-09254-34
cm Scale cm/Inch Scale



Collin
28-09258-35
35 cm/13¾"
cm Scale



Breisky
28-09262-33
33 cm/13"
cm Inch Scale



Collyer
28-09266-30
30 cm/12"
cm Inch Scale



Iowa
28-09270-14
14 cm/5½"
Trumpet Needle Guide



Winter
28 cm/11"

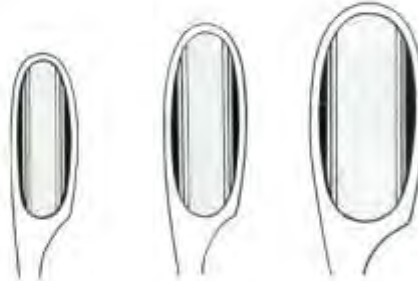

Straight 28-09274-01 28-09274-02 28-09274-03

Curved 28-09275-01 28-09275-02 28-09275-03



Wallich
28-09278-42
42 cm/16¾"



Sanger
21 cm/10½"

Straight
28-09282-27

Curved
28-09283-27

Uterine Haemostasis Forceps



Green-Armytage
28-09286-21
21 cm/8¼"

Scalp Flap Forceps



Gauss
28-09290-26
26 cm/10¼"



Willet-Martel
28-09294-19
19 cm/7½"

Head Lever



Murless
28-09298-26
26 cm/10¼"

Elevating Spoon



Sellheim
28-09302-28
28 cm/11"



Smellie
28-09306-25
25 cm/10"

Perforators



Nagele
28-09310-25
25 cm/10"

Cranioclast



Braun
28-09314-42
42 cm/16½"

Basiotribe



Tarnier
28-09318-46
46 cm/18"

Decapitating Hook



Braun
28-09322-30
30 cm/12"

Umbilical Cord Clamps



Collin
28-09326-09
9 cm/3½"



Nagele
28-09330-36 36 cm/14"
28-09330-40 40 cm/16"



Wrigley
28-09334-28
28 cm/11"



Simpson
28-09338-23
23 cm/9"



Simpson
28-09340-30
30 cm/12"



Simpson-Braun
28-09342-36
36 cm/14"



Simpson-Luikart
28-09344-36
36 cm/14"



De Lee
28-09348-30 30 cm/12"
28-09348-36 36 cm/14"

Traction Handles to be used with all obstetrical Forceps with Standard type Handles



Bill
28-09350-20



Kielland
28-09352-41
41 cm/16"



Kielland-Luikart
28-09354-40
40 cm/15¾"



Mclean
28-09358-36
36 cm/14"



Elliot
28-09362-32 32 cm/12½"
28-09362-38 38 cm/15"



Piper
28-09366-44
44 cm/17¼"



With Traction Handle

Barnes-Neville
28-09370-43
43.5 cm/17"



With Traction Handle

Tarnier
28-09374-40
40 cm/15¾"

Cardiovascular Instruments Rib Shears, Sternum Scissors and Sternum Chisels



Sauerbruch
29-09378-24 24 cm/9½"
29-09378-26 26 cm/10¼"



Giertz-Stille
29-09382-27
27 cm/10½"



Sauerbruch-Frey
29-09386-36
36 cm/14"



Bethune
29-09390-34
34 cm/13½"



Brunner
29-09394-32
32 cm/12½"

29-09394-32
For the Right Hand

29-09395-32
For the left Hand



Lebsche
29-09398-24
24.5 cm/9¾"



Finocchietto-Baby

	a	b	c
29-09402-00	18 mm	21 mm	105 mm

Scheme of Dimensions

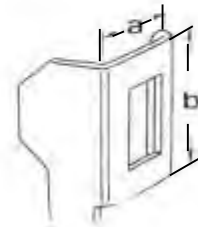

Size of Blades



Total Spread



Finocchietto

	a	b	c
29-09406-01	36 mm	45 mm	165 mm
29-09406-02	44 mm	65 mm	200 mm
29-09406-03	44 mm	65 mm	250 mm
29-09406-04	44 mm	65 mm	300 mm
29-09406-05	65 mm	65 mm	200 mm
29-09406-06	65 mm	65 mm	250 mm
29-09406-07	65 mm	65 mm	300 mm

With 2 Pairs of Interchangeable Blades



Finocchietto-Burford

Blade Opening
29-09410-01 200 mm/8"
29-09410-02 250 mm/10"
29-09410-03 305 mm/12"



Tuffier

29-09414-00 a b c
50 mm 45 mm 165 mm



Haight

	a	b	c
29-09418-00	30 mm	30 mm	115 mm

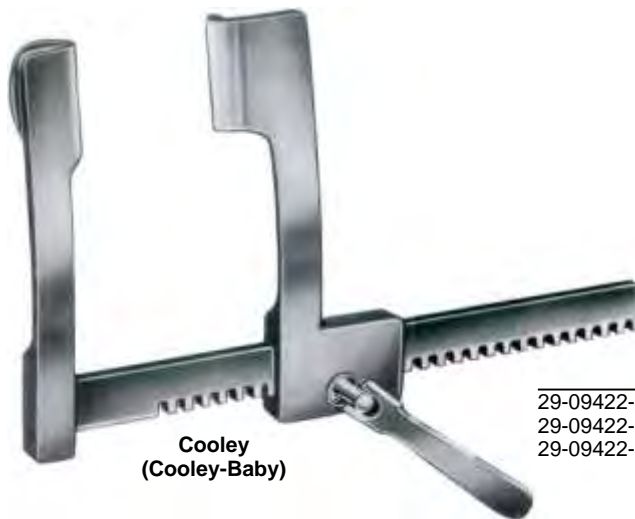

Cooley
(Cooley-Baby)

	a	b	c
29-09422-01	15 mm	30 mm	75 mm
29-09422-02	21 mm	45 mm	145 mm
29-09422-03	32 mm	50 mm	190 mm

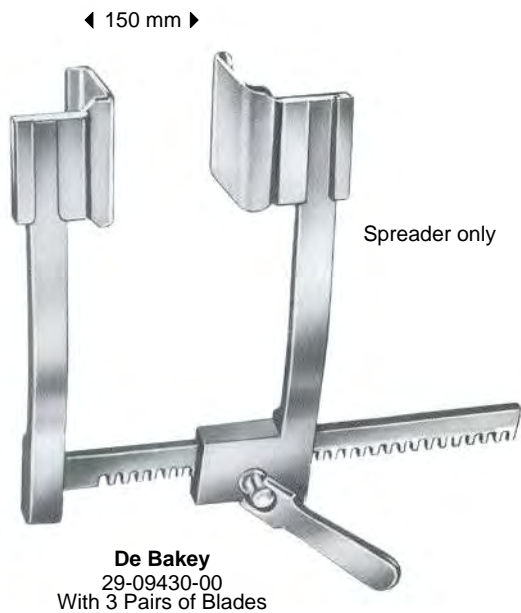

◀ Fig. 1 15 cm/6" ▶
◀ Fig. 2 20 cm/8" ▶



Morse-Favaloro
Fig. 1 29-09434-01
Fig. 2 29-09434-02

75 x 75 mm

42 x 65 mm

Thoracic Retractor



(Mercedes-Retractor)
29-09436-00
Complete

Cardiovascular Instruments Rib Spreaders



**Cooley
(Cooley-Baby)**

	a	b	c
29-09438-01	12 mm	17 mm	75 mm
29-09438-02	16 mm	30 mm	105 mm
29-09438-03	37 mm	49 mm	200 mm



Castaneda

	a	b	c
29-09442-01	10.5 mm	32 mm	65 mm
29-09442-02	12 mm	45 mm	70 mm
29-09442-03	15 mm	60 mm	120 mm



Finocchietto-Baby-Haight

	a	b	c
29-09446-01	15 mm	15 mm	75 mm
29-09446-02	31 mm	31 mm	100 mm
29-09446-03			



Finocchio

	a	b	c
29-09450-01	38 mm	44 mm	135 mm
29-09450-02	52 mm	62 mm	135 mm
29-09450-03	85 mm	65 mm	135 mm



Burford
With 2 Pairs of Blades

For Child	a	b	c
	48 mm	42 mm	135 mm
29-09454-00	34 mm	42 mm	135 mm
29-09454-01	65 mm	62 mm	180 mm
	47 mm	62 mm	
29-09454-02	65 mm	62 mm	260 mm
	47 mm	62 mm	
29-09454-03	65 mm	62 mm	300 mm
	47 mm	62 mm	



Lemmon
29-09458-18
18 cm/7"



Sellors
29-09462-19
19 cm/7½"



Bailey-Baby
29-09466-14
14 cm/5½"



Bailey
29-09470-16
16 cm/6¼"



Bailey-Gibbon
29-09474-16
16 cm/6¼"



Allison
29-09478-25 25.5 cm/10"
29-09478-30 30.0 cm/12"

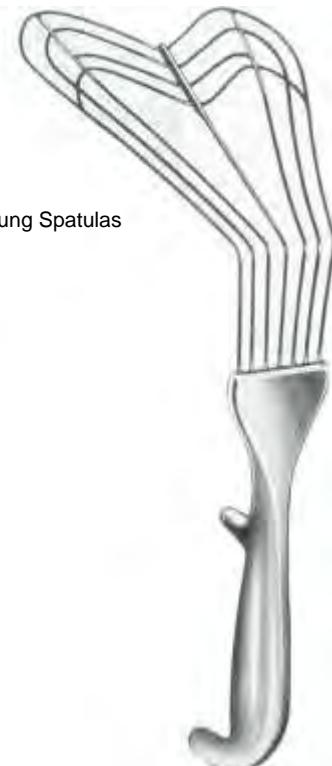

Lung Spatulas

29-09482-30
30 cm/12"



Price-Thomas
29-09486-22
22 cm/8¾"

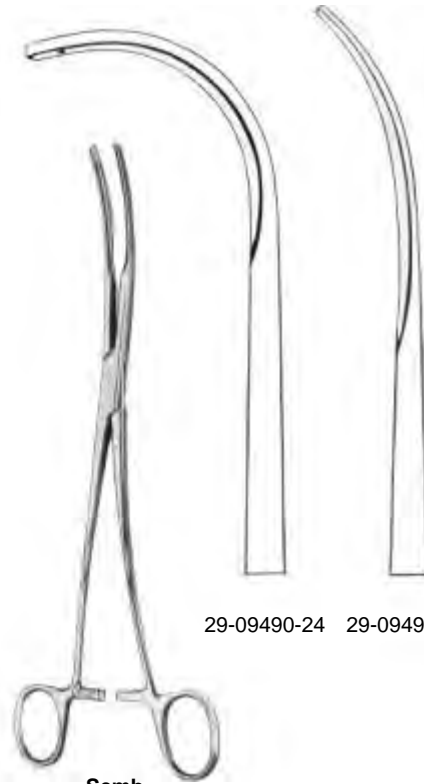

29-09490-24 29-09492-24

Semb
24 cm/9½"

Lung grasping forceps



Lovlace
29-09496-20
20 cm/8"



Lovlace
29-09500-20
20 cm/8"



Fig. 1

Fig. 2



29-09504-01
29-09504-02

Satinsky
26.5 cm/10½"
Fig. 1
Fig. 2



29-09508-01
29-09508-02

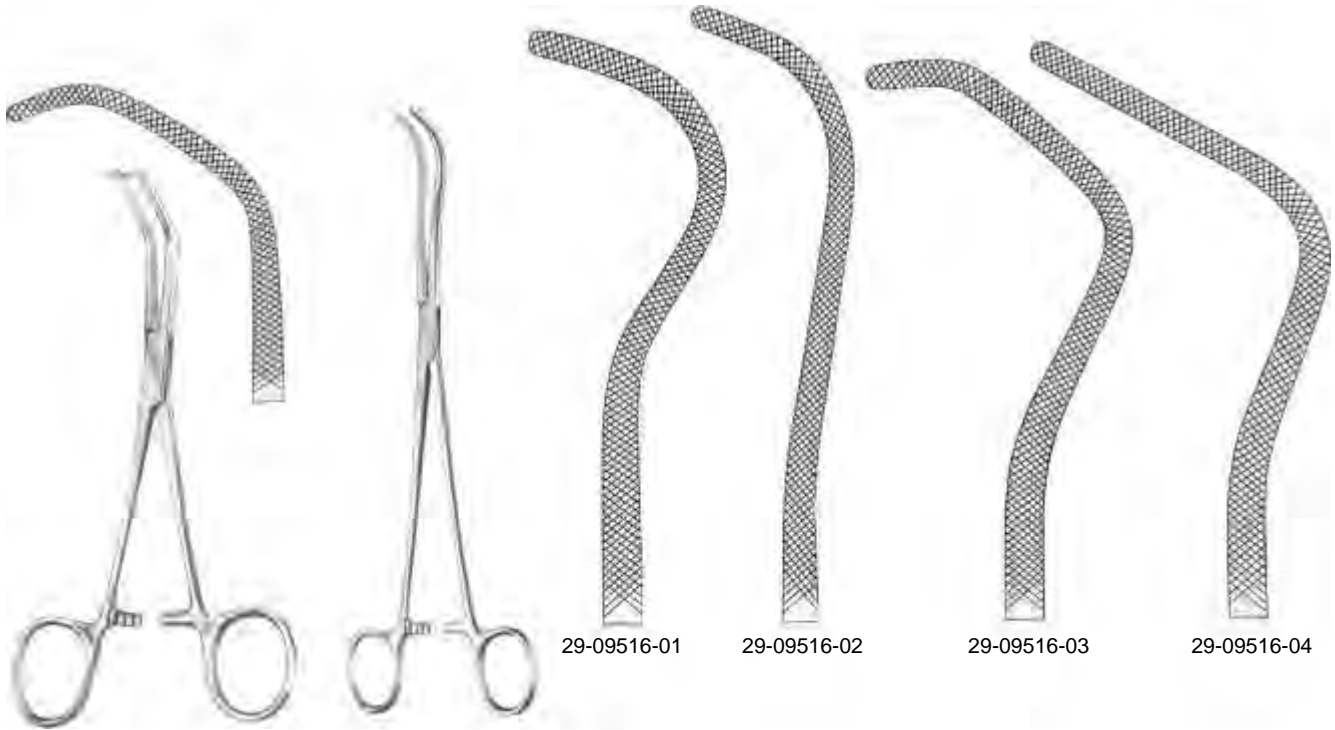

Baby-Satinsky
29-09512-15
15 cm/6"

Harken
24 cm/9½"

29-09516-01

29-09516-02

29-09516-03

29-09516-04

AtraumaTC

Atrauma tissue forceps



De Bakay

Wide

29-09520-15	15.0 cm/6"	1.5 mm
29-09520-19	19.5 cm/7½"	1.5 mm
29-09520-24	24.0 cm/9½"	1.5 mm



De Bakey

	1.2 mm	2.0 mm	Wide
29-09524-18		29-09526-18	18 cm/7"
29-09524-21		29-09526-21	21 cm/8¼"

Atrauma



Cooley

29-09530-15	15.0 cm/6"
29-09530-19	19.5 cm/7½"
29-09530-24	24.0 cm/9½"



De Bakey

Wide	1.5 mm	2.0 mm	2.7 mm	3.5 mm
16 cm/6¼"	29-09534-16	29-09536-16	29-09538-16	29-09540-16
20 cm/8"	29-09534-20	29-09536-20	29-09538-20	29-09540-20
24 cm/9½"	29-09534-24	29-09536-24	29-09538-24	29-09540-24
30 cm/12"	29-09534-30	29-09536-30	29-09538-30	29-09540-30



De Bakey

Wide 2.0 mm
29-09543-16
29-09543-20
29-09543-24
29-09543-30

Setting forceps



29-09546-23
23 cm/9"



De Bakey



29-09550-07	7.5 cm/3"	29-09551-07
29-09550-08	8.5 cm/3½"	29-09551-08
29-09550-10	10.5 cm/4¼"	29-09551-10
29-09550-12	12.0 cm/4¾"	29-09551-12



29-09554-03
3.5 cm/1½"



29-09555-03
3.5 cm/1½"



29-09558-04
4.5 cm/1¾"



29-09559-04
4.5 cm/1¾"



De-Bakey
29-09562-05
5.0 cm/2"



De-Bakey
29-09563-05
5.0 cm/2"



De Bakey



Glover		Glover	
29-09566-06	6 cm/2½"	29-09567-06	
29-09566-07	7 cm/2¾"	29-09567-07	
29-09566-09	9 cm/3½"	29-09567-09	
29-09566-11	11 cm/4½"	29-09567-11	



Glover
29-09571-06
5 cm/2"



De Bakey-Satinsky
29-09575-07
7 cm/2¾"



De Bakey



De Bakey-Carotid
29-09579-09
9 cm/3½"



De Bakey-Satinsky
29-09583-10
10 cm/4"

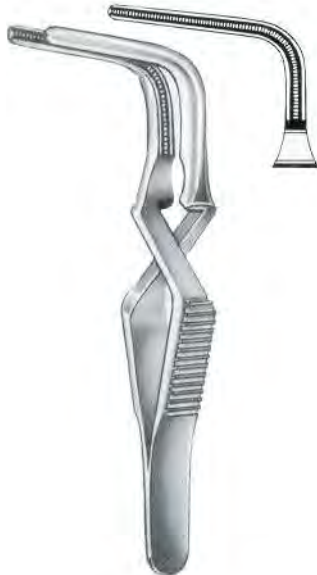

Santulli
29-09587-07
7 cm/2¾"



Gregory-Soft
29-09591-09 29-09593-11
9 cm/3½" 11 cm/4½"



De Bakey

Coarctation Clamps



**Potts
(De Bakey)**



29-09596-21
21 cm/8¼"



29-09596-22
22 cm/8¾"



**Potts
(De Bakey)**



29-09599-21
21 cm/8¼"



29-09599-22
22 cm/8¾"



Potts



29-09601-21
21 cm/8¼"



29-09601-22
22 cm/8¾"

Anastomosis Clamps



**Glover
(Potts)**



De Bakey



29-09605-21
21 cm/8¼"



29-09605-22
22 cm/8½"

Dissecting and
Ligature Forceps

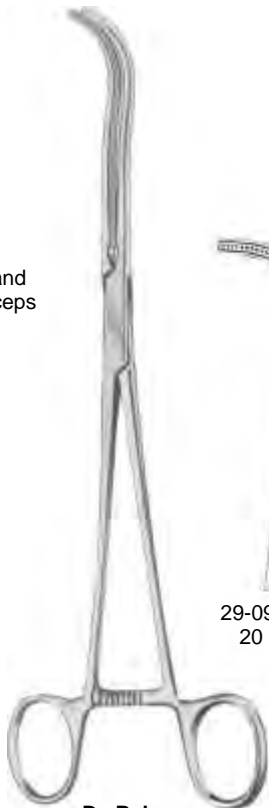

De Bakey



29-09609-20
20 cm/8"



29-09609-24
24 cm/9½"



De Bakey



29-09613-20
20 cm/8"



29-09615-18
18 cm/7½"



De Bakey



Leland-Jones



29-09618-01
19.5 cm/7½"

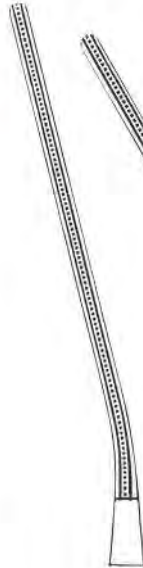

29-09618-02
19.5 cm/7½"

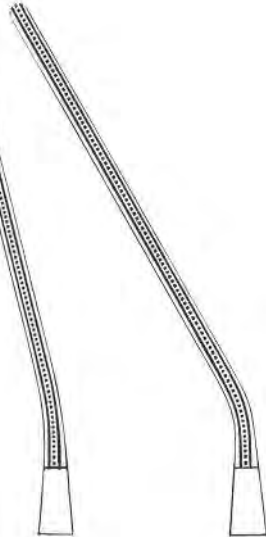

29-09618-03
19.5 cm/7½"



Leland-Jones
29-09621-18
18 cm/7"



De Bakey-Bainbirdge



29-09624-15
15 cm/6"



29-09624-18
18 cm/7"



29-09625-15
15 cm/6"



29-09625-18
18 cm/7"



De Bakey
29-09629-20
20 cm/8"



De Bakey

Aortic Aneurysm Clamps

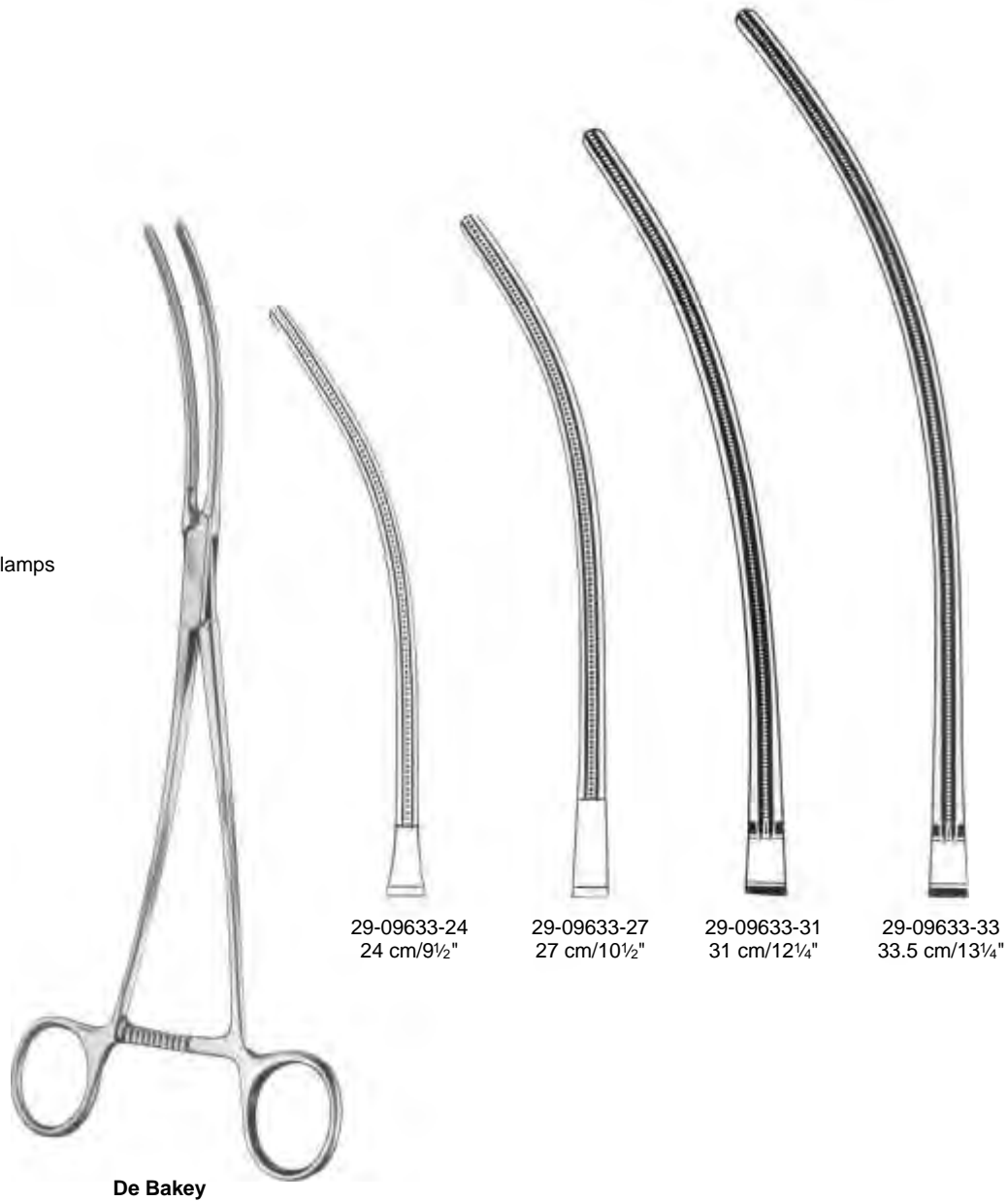



De Bakey

Aortic Aneurysm Clamps



De Bakey
29-09637-28
28 cm/11"



29-09641-30
30 cm/12"



De Bakey

Aortic Clamps



Ochsner
29-09645-23
23.5 cm/9¼"



Dietrich
29-09649-21
21 cm/8¼"



De Bakey

Auricle Clamp



Harken



29-09653-01
24 cm/9½"



29-09653-02
24 cm/9½"



29-09653-03
24 cm/9½"



29-09653-04
24 cm/9½"



De Bakey

Bronchus Clamps

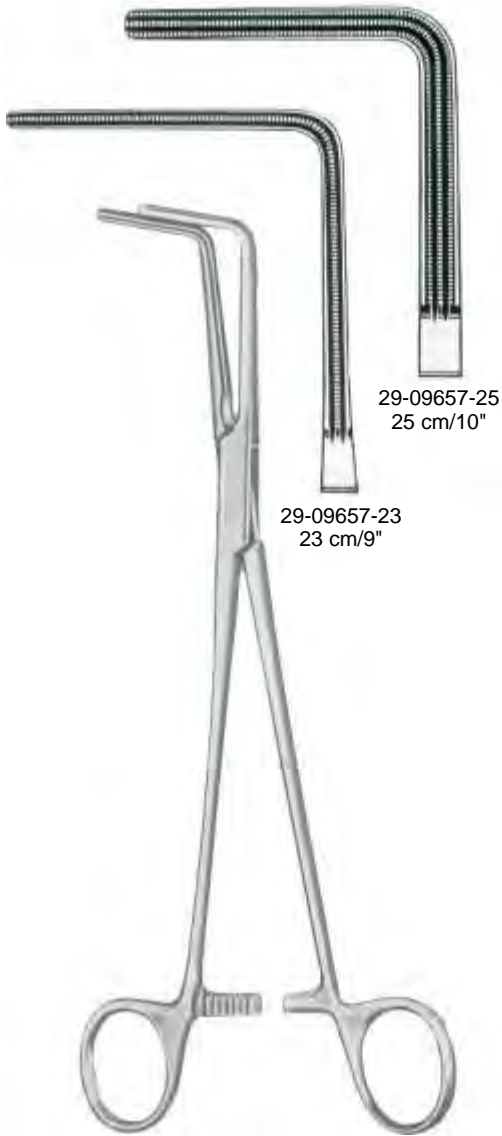

Lees



Lees
29-09661-25
25 cm/10"



De Bakey

Aortic Clamp

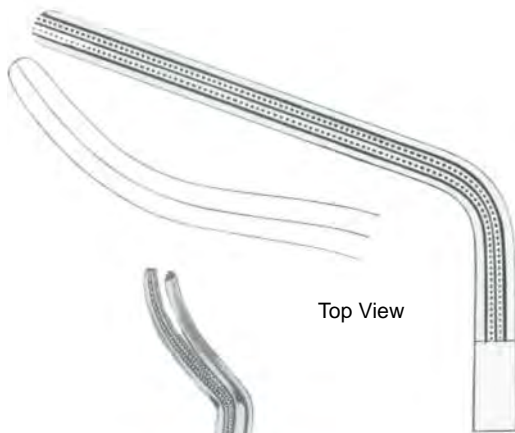

Top View



De Bakey
29-09665-27
27 cm/10½"



De Bakey
29-09669-24
24 cm/9½"

Ligature Clamps



De Bakey
29-09673-24
24 cm/9½"



De Bakey

Ligature clamp,
Aortic clamp



De Bakey
29-09677-26
26.5 cm/10½"

De Bakey-Semb
29-09677-25
25 cm/10"

De Bakey-Semb

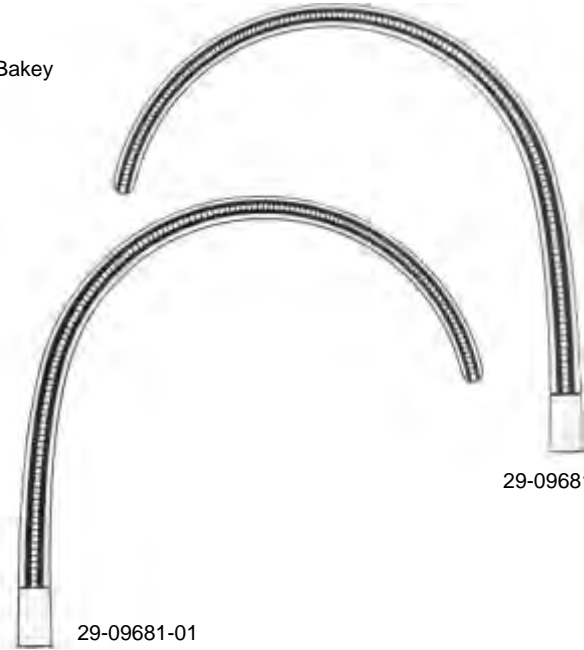

29-09681-01

29-09681-02

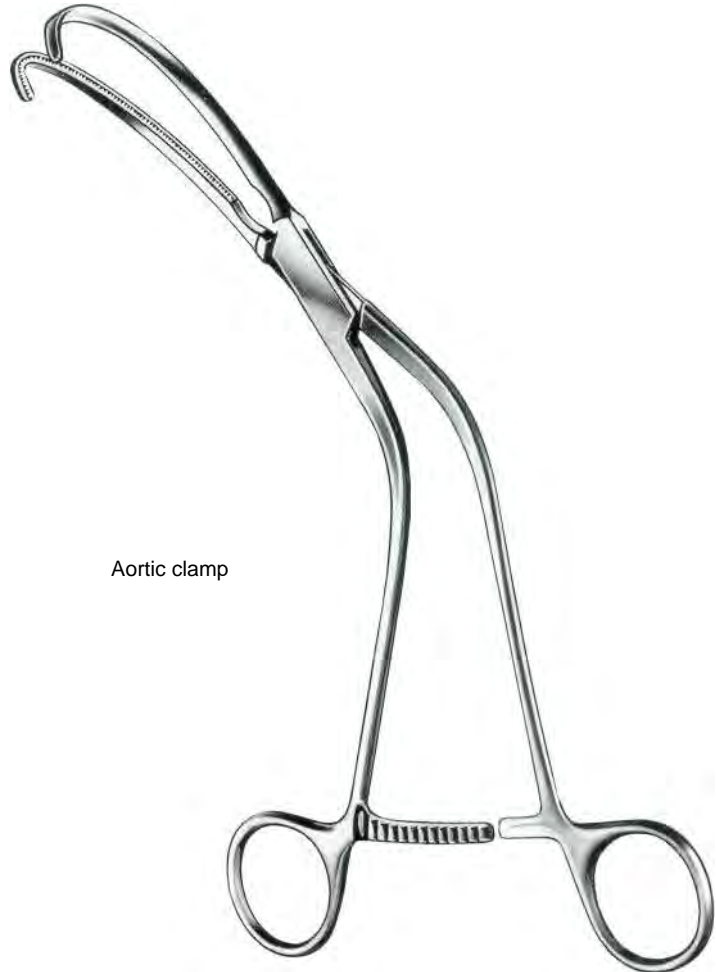

Aortic clamp

Weber
26 cm/10¼"



Tangential occlusion clamps

Satinsky/De Bakey



De Bakey

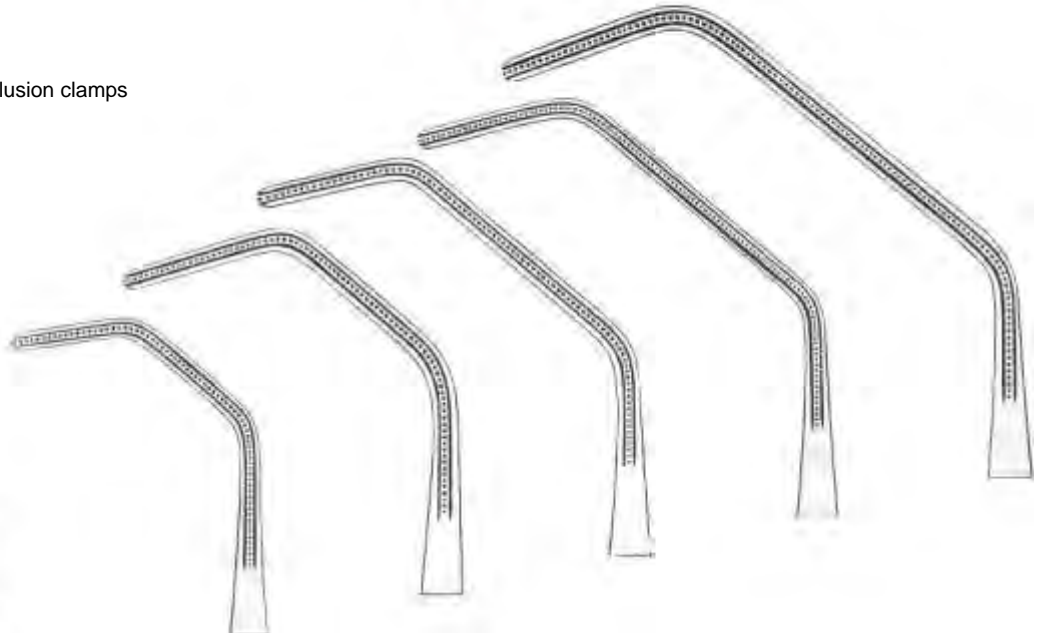

Set of 5 purchase.
29-09685-00

29-09685-20
20 cm/8"

29-09685-25
25 cm/10"

29-09685-26
26 cm/10¼"

29-09685-27
27 cm/10½"

29-09885-28
28 cm/11"



Glover

29-09689-01 19.5 cm/7¾"
29-09689-02 21.0 cm/8¼"

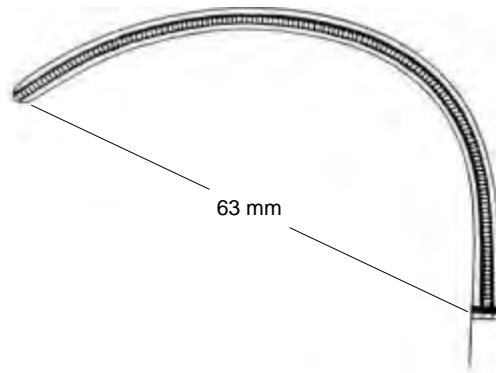

Anastomosis

63 mm

29-09689-01

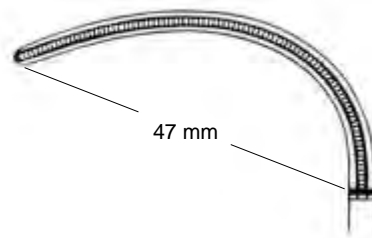

47 mm

29-09689-02



De Bakey



Lambert-Kay
21 cm/8¼"



29-09695-21

29-09693-21

Aortic anastomosis clamps



De Bakey
29-09699-17
17 cm/6¾"



Beck
29-09703-17
17 cm/6¾"



De Bakey



De Bakey
29-09707-16
16 cm/6 1/4"

Graduated

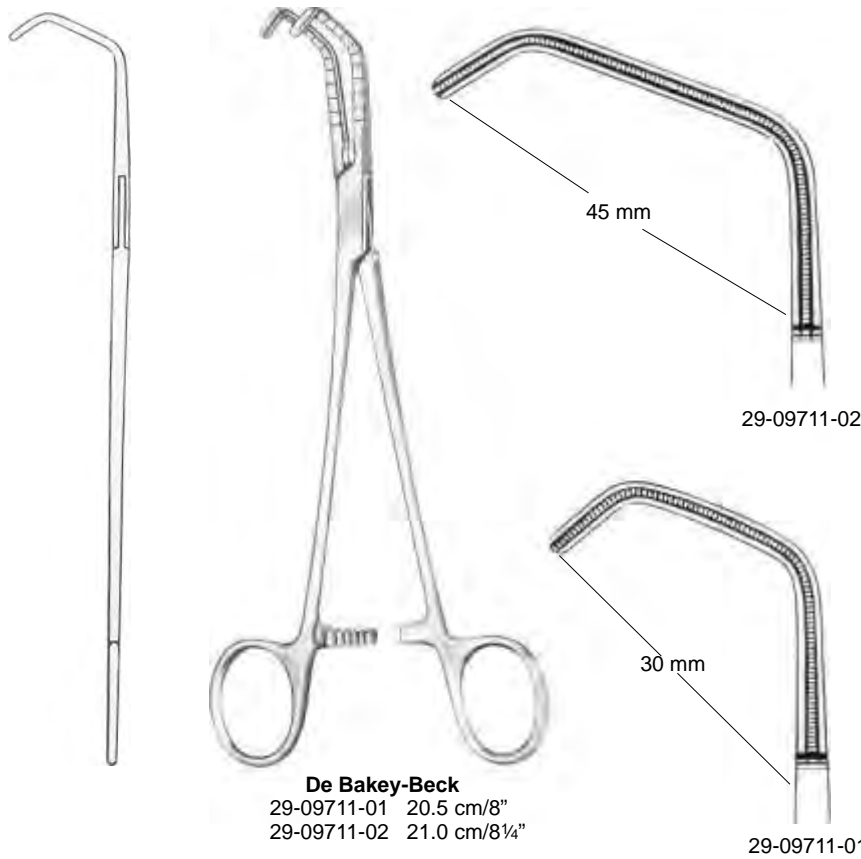

De Bakey-Beck
29-09711-01 20.5 cm/8"
29-09711-02 21.0 cm/8 1/4"

29-09711-02

29-09711-01



29-09714-00



15°
29-09715-15



30°
29-09715-30

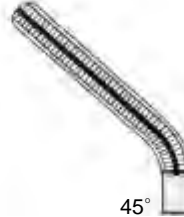

45°
29-09715-45

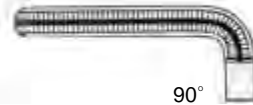

90°
29-09715-90



29-09718-00



15°
29-09719-15



30°
29-09719-30



45°
29-09719-45



90°
29-09719-90



Dardik
17 cm/6³/₄"



De Bakey

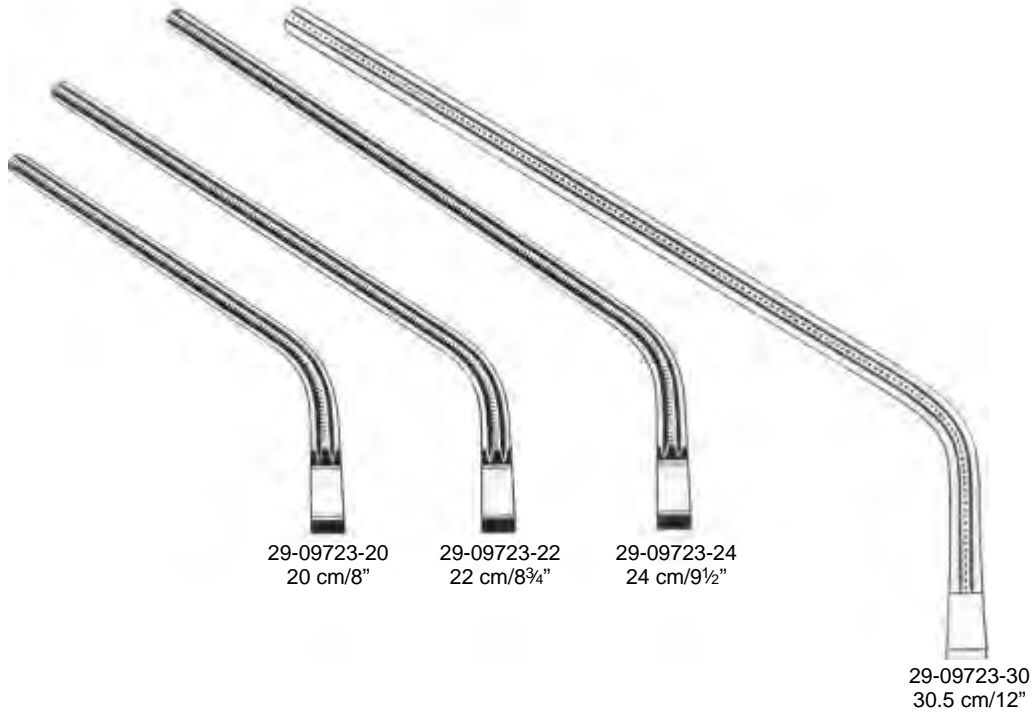

Multi purpose clamps

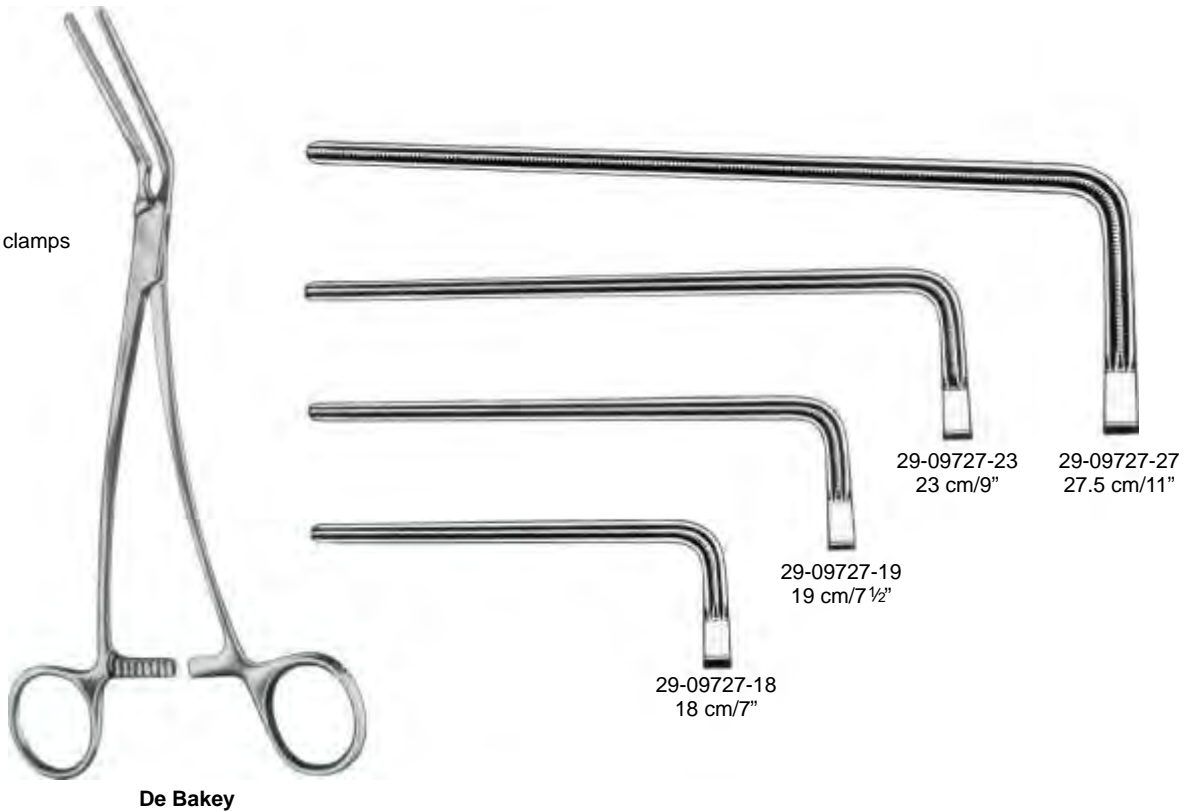

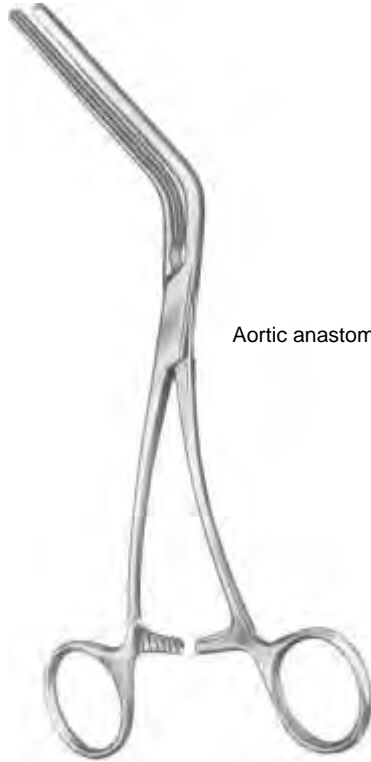

Aortic anastomosis clamps

Morris-De Bakey



29-09731-18
18 cm/7"

29-09731-20
20 cm/8"

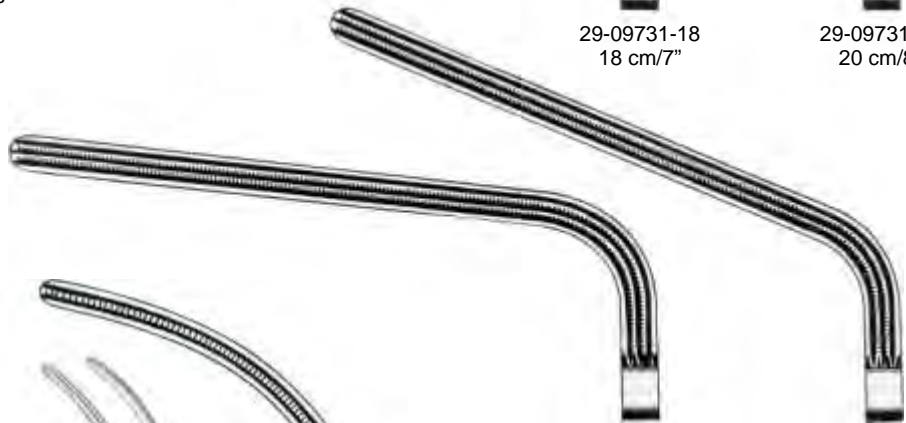

29-09731-23
23 cm/9"

29-09731-25
25 cm/10"



Glover
29-09735-24
24.5 cm/9¾"

Aorta aneurysm clamps



De Bakey-Bahnson



De Bakey



29-09739-24
24.5 cm/9¾"



29-09739-25
25.5 cm/10"



29-09739-26
26.5 cm/10½"

Coarctation clamps



	Straight	cm/in	Curved
	29-09742-21	21.5 cm/8½"	29-09743-21
	29-09742-23	23.0 cm/9"	29-09743-23
	29-09742-27	27.0 cm/10½"	29-09743-27
	29-09742-31	31.5 cm/12½"	29-09743-31



De Bakey



Mosquito
12 cm/4¾"

29-09746-12

29-09747-12

Atrauma hemostatic forceps



De Bakey-Pean



29-09750-14
14 cm/5½"



29-09750-16
16 cm/6¼"



29-09750-18
18 cm/7"



29-09750-20
20 cm/8"



29-09751-14
14 cm/5½"



29-09751-16
16 cm/6¼"



29-09751-18
18 cm/7"



29-09751-20
20 cm/8"

Multi purpose clamps



De Bakey



De Bakey-Rankin



29-09754-16 16 cm/6¼"
29-09755-16 16 cm/6¼"



Cooley



29-09759-16
16 cm/6¼"



29-09759-15
15.5 cm/6"



29-09759-14
14.5 cm/5¾"



De Bakey
29-09762-17
17 cm/6¾"

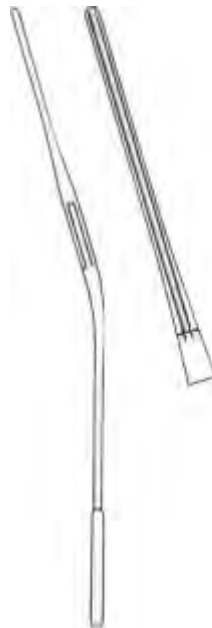

29-09763-17

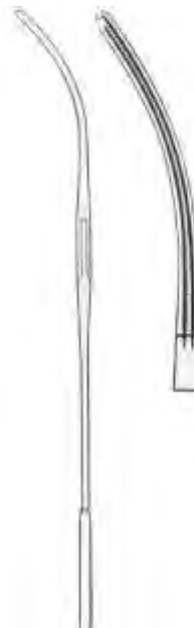

29-09765-17



29-09767-17



De Bakey

Ligature Clamps

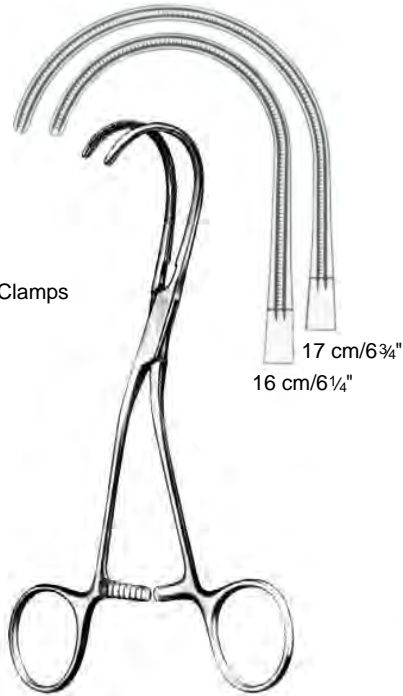

29-09771-16 16cm/6 1/4"
29-09771-17 17cm/6 3/4"

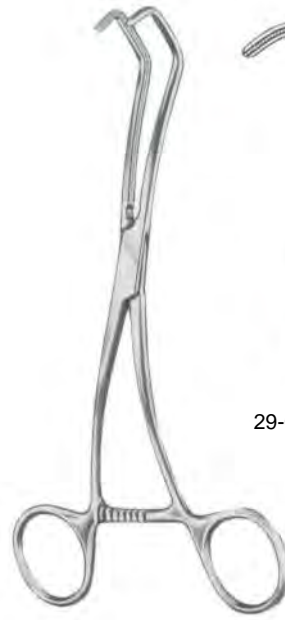

Derra-De Bakey
17 cm/6 3/4"



29-09775-01 29-09775-02 29-09775-03
Anastomosis Clamps

Profunda Clamps

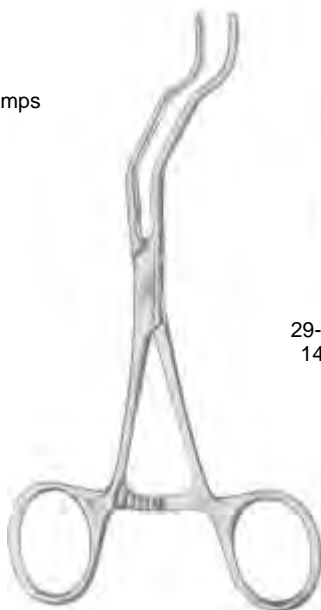

Gregory



29-09779-14
14 cm/5 1/2"



29-09779-16
16 cm/6 1/4"



29-09779-18
18 cm/7"



De Bakey
29-09782-12
12 cm/4¾"



De Bakey



De Bakey



29-09783-10
10 cm/4"

29-09783-11
10.5 cm/4½"

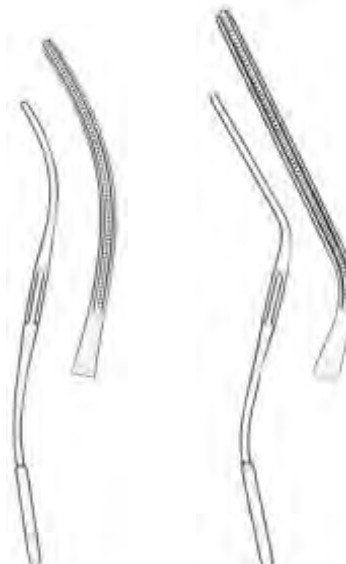

29-09783-12
12 cm/4¾"

29-09783-13
13 cm/5"

Carotid Clamps

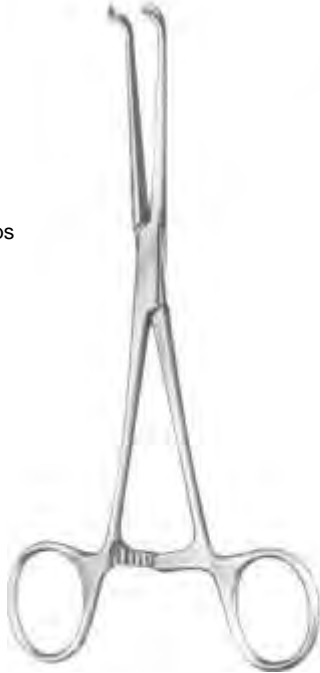

Javid
29-09787-18
18 cm/7"



Javid
29-09787-19
19 cm/7½"



Cooley

Charriere (French)	Length cm	
24	16	29-09789-24
26	16	29-09789-26
28	20	29-09789-28
30	20	29-09789-30
32	20	29-09789-32
36	20	29-09789-36



Cooley

Coarctation Clamps



Cooley
29-09792-17
17 cm/6¾"



29-09793-17
17 cm/6¾"



29-09795-17
17 cm/6¾"

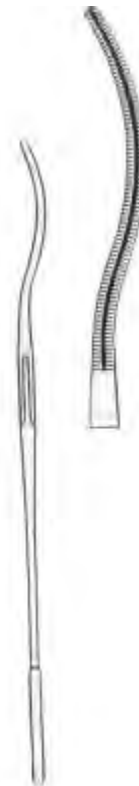

29-09797-17
17 cm/6¾"



Cooley



Cooley
29-09799-20
20 cm/8"



Cooley



29-09801-03
17 cm/6¾"



29-09801-02
15.5 cm/6"



29-09801-01
15 cm/6"



Cooley
29-09803-17
17 cm/6¾"

Anastomosis clamps



Cooley



Cooley



29-09807-01
16.5 cm/6½"

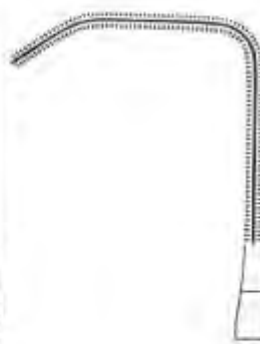

29-09807-02
16.5 cm/6½"

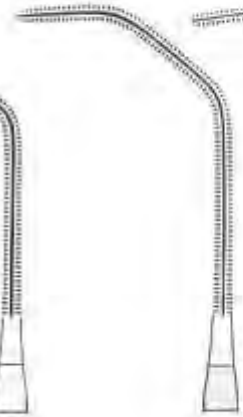

29-09807-03
17.5 cm/7"



29-09807-04
17.5 cm/7"

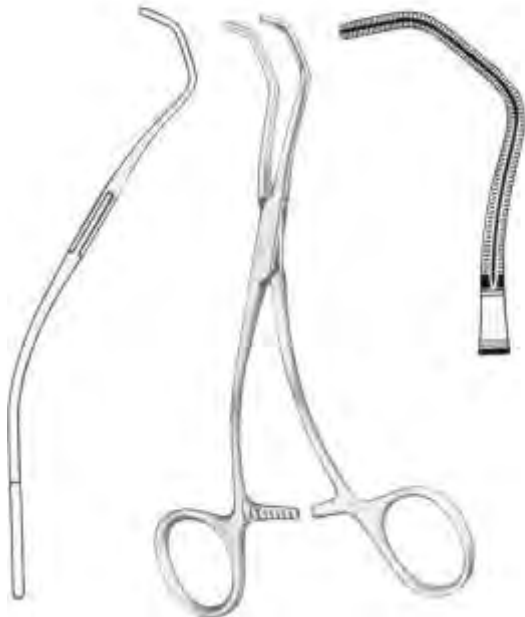

Cooley
29-09811-16
16 cm/6¼"



Beck
29-09815-17
17 cm/6¾"



Cooley



Cooley-Derra

29-09819-16
16 cm/6 1/4"



29-09819-17
17 cm/6 3/4"



29-09819-18
18 cm/7"



Cooley

29-09823-16 16 cm/6 1/4"
29-09823-17 17 cm/6 3/4"

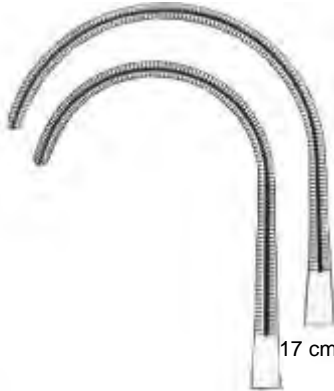

16 cm/6 1/4"

17 cm/6 3/4"

Ligature clamps



Cooley



29-09826-14 29-09827-14

Cooley
14 cm/5½"



Cooley
29-09830-14
14 cm/5½"



Cooley
29-09833-14
14 cm/5½"



Cooley
29-09837-14
14 cm/5½"



Fig.	Straight
1	29-09842-01
2	29-09842-02
3	29-09842-03
4	29-09842-04
5	29-09842-05
6	29-09842-06
7	29-09842-07
8	29-09842-08
9	29-09842-09



Fig.	Angled
1	29-09843-01
2	29-09843-02
3	29-09843-03
4	29-09843-04
5	29-09843-05
6	29-09843-06
7	29-09843-07
8	29-09843-08
9	29-09843-09



Fig.	Curved
1	29-09845-01
2	29-09845-02
3	29-09845-03
4	29-09845-04
5	29-09845-05
6	29-09845-06
7	29-09845-07
8	29-09845-08
9	29-09845-09





29-09847-01
13 cm/5"



29-09847-02
13 cm/5"



29-09847-03
13 cm/5"



Castaneda



29-09847-04
15 cm/6"



29-09847-05
15 cm/6"



29-09847-06
15 cm/6"



29-09847-07
15 cm/6"



Cooley
29-09849-01
25 cm/10"



Cooley
29-09849-02
33 cm/13"



Cooley
29-09849-03
30 cm/12"



Cooley
29-09849-04
30 cm/12"



Cooley
29-09849-05
35 cm/13³/₄"

Tourniquets



Rumel-Belmont
29-09851-32 3.2 mm Ø
29-09851-64 6.4 mm Ø



Cooley
29-09853-00



Gerbode
29-09854-00



Tubbs
29-09855-00



De Bakey

mm Ø	19 cm/7½"	35 cm/14"
0.5	29-09857-05	29-09858-05
1.0	29-09857-10	29-09858-10
1.5	29-09857-15	29-09858-15
2.0	29-09857-20	29-09858-20
2.5	29-09857-25	29-09858-25
3.0	29-09857-30	29-09858-30
3.5	29-09857-35	29-09858-35
4.0	29-09857-40	29-09858-40
4.5	29-09857-45	29-09858-45
5.0	29-09857-50	29-09858-50
7.0	29-09857-70	29-09858-70
9.0	29-09857-90	29-09858-90

Malleable



Cooley
13 cm/5"

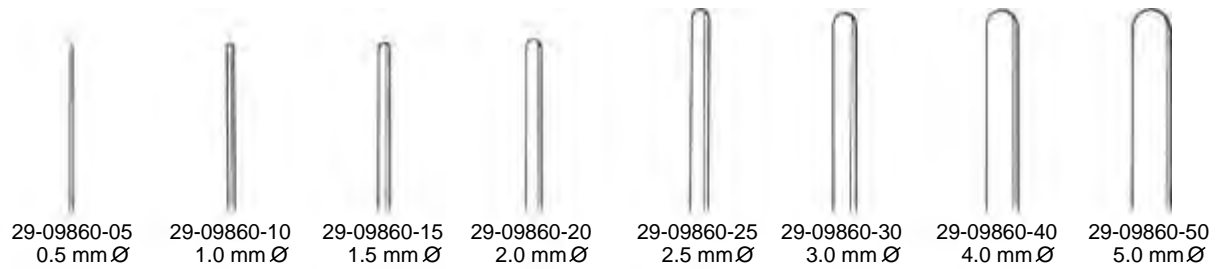



Children
30-09862-07
7 cm/2¾"

Weiss

Adults
30-09862-09
9 cm/3½"



Children
30-09864-07
7 cm/2¾"

Weiss

Adults
30-09864-09
9 cm/3½"



Park
30-09868-08
8 cm/3¼"



Park-Guyton
30-09870-08
8 cm/3¼"



Park-Maumenee
30-09872-08
8 cm/3¼"



Children
30-09874-03
3 cm/1¼"

Barraquer (Colibri)

Adults
30-09874-04
4 cm/1½"



Barraquer
30-09876-04
4 cm/1½"



Bowman
30-09878-07
7 cm/2¾"



Sauer
30-09880-03
3 cm/1¼"



Goldstein
30-09884-03
3 cm/1¼"



Pley
30-09888-06
6 cm/2¼"

For left eye

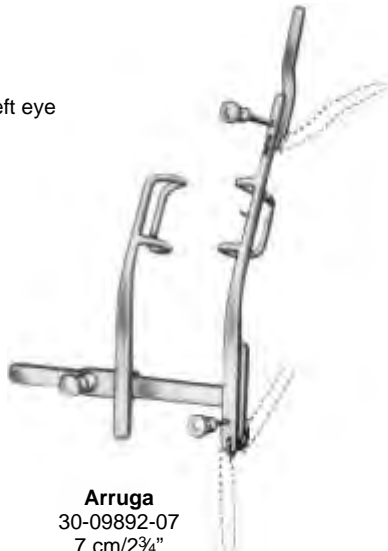

Arruga
30-09892-07
7 cm/2¾"

For right eye



Arruga
30-09894-07
7 cm/2¾"



Mellinger-Axenfeld
30-09898-07
7 cm/2¾"



Mellinger-Axenfeld
30-09900-07
7 cm/2¾"



Children
30-09904-05
5 cm/2¾"



Mellinger Adults
30-09904-07
7 cm/2¾"



Children	Mellinger Beard	Adults
30-09908-05		30-09908-07
5 cm/2"		7 cm/2¾"



Knapp Clark
30-09912-08
8 cm/3¼"



Children	Graefe	Adults
30-09916-06		30-09916-09
6 cm/2½"		9 cm/3½"



Children	Cook	Adults
30-09920-04		30-09920-05
4 cm/1½"		5 cm/2"



Lancaster
30-09924-08
8 cm/3¼"



Children	Williams	Adults
30-09928-07		30-09928-08
7 cm/2¾"		8 cm/3¼"



Lister-Burch
30-09932-08
8 cm/3¼"



Weiss
30-09936-08
8 cm/3¼"



Murdock
30-09940-05
5 cm/2"



Mueller
30-09944-07
7 cm/2¾"



Critchett
30-09948-06
6 cm/2½"



Castroviejo
30-09952-08
8 cm/3¼"



Stevenson
30-09956-07
7 cm/2¾"



Agricola
30-09960-04
4 cm/1½"



Schepens
30-09964-13
13 cm/5"



Desmarres
30-09968-13
13 cm/5"



8 mm

Conway
30-09972-13
13 cm/5"



Desmarres
13 cm/5"

30-09976-12
12 mm

30-09976-14
14 mm

30-09976-16
16 mm

30-09976-18
18 mm

Lid plate



Jaeger
30-09980-11
11 cm/4 1/2"

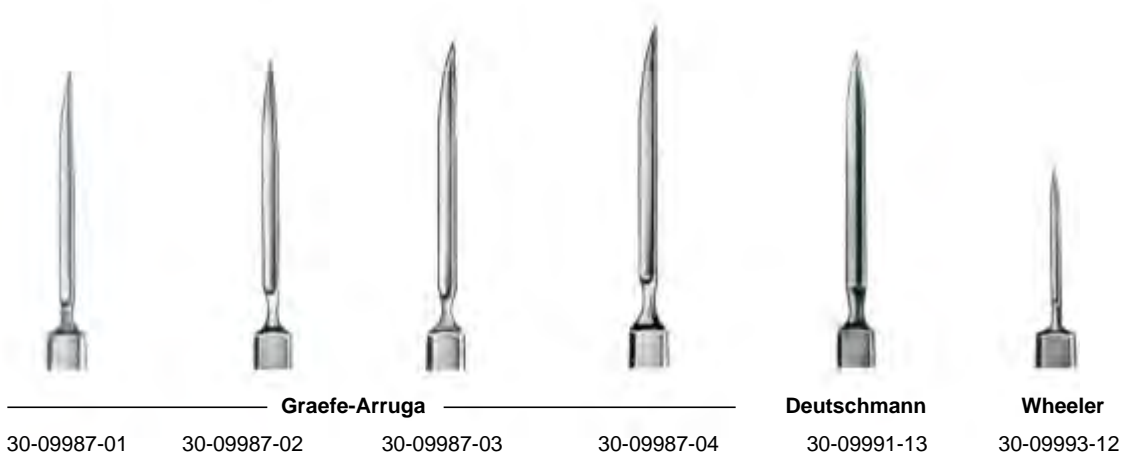
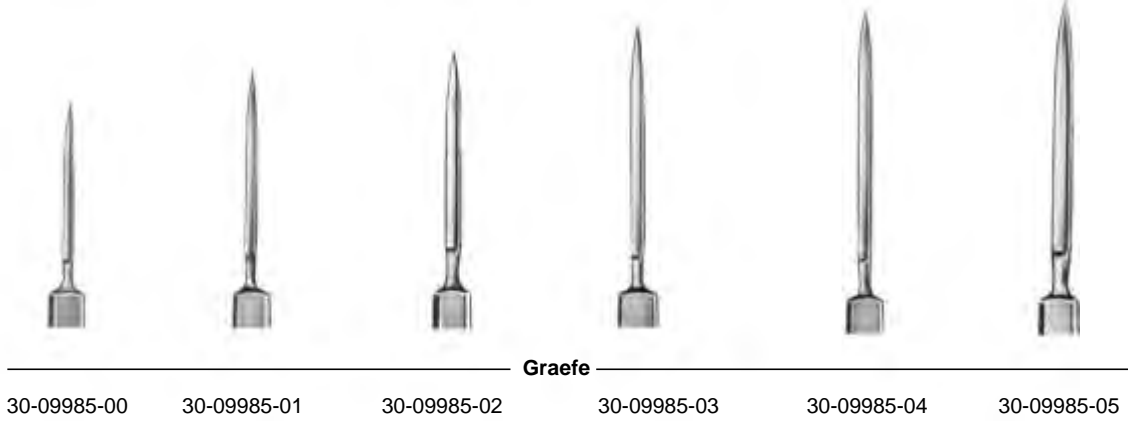
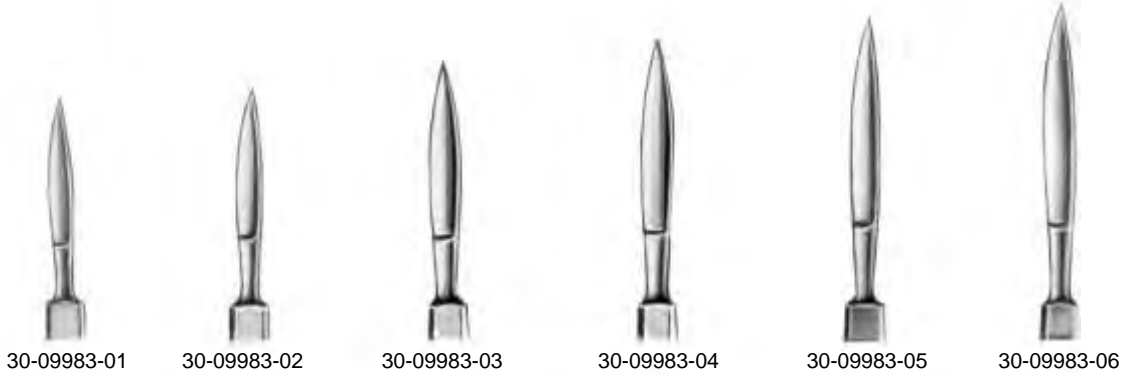



Jaeger
30-09997-01



30-09997-02



30-09997-03



30-09997-04



30-09999-01



30-09999-02



30-09999-03



30-09999-04



30-10001-01



30-10001-02



30-10001-03



30-10001-04



30-10003-01



30-10003-02



30-10003-03



30-10003-04

Jaeger-Grieshaber



30-10005-01



30-10005-02



30-10005-03



30-10005-04

Jaeger-Grieshaber



Wessely-Grieshaber

30-010007-01 30-010007-02 30-010007-03 30-010007-04
4 mm 5 mm 6 mm 7 mm



Wiener
30-010009-13

Berens
30-010011-13



Papst
30-010013-13



Castroviejo
30-010015-13



Castroviejo
30-010019-01
9 cm/3½"



Castroviejo
30-010019-02
9 cm/3½"



Castroviejo
30-010019-03
9 cm/3½"



Mod. Hamburg
30-010023-12



Graefe
30-010025-13



30-010027-01



Weber
30-010027-02



30-010027-03



Bowman
30-010029-04
0.4 mm



Bowman
30-010029-05
0.5 mm



Bowman
30-010029-06
0.6 mm



Bowman
30-010029-07
0.7 mm



Bowman
30-010029-08
0.8 mm



Left **Bowman** Right
30-010031-01 30-010031-02



30-010033-01



30-010033-02



30-010033-03



30-010035-05
5 mm



30-010035-06
6 mm



30-010035-07
7 mm



Dean
30-010037-13



Zigler
30-010039-11
3½ mm



Sato
30-010041-12



Sichel
30-010043-13



Graefe
30-010045-13



Graefe
30-010047-13



Kuhnt
30-010049-01



Kuhnt
30-010049-02



Kuhnt
30-010049-03



Kuhnt
30-010049-04



Paton
30-010051-12



Elsching
30-010053-13



Took
30-010055-12



Desmarres
30-010057-01



Desmarres
30-010057-02



Desmarres
30-010057-03



Gill
30-010059-12



Anderson-Critchett
30-010061-12



Lundsgaard
30-010063-12



Guyton-Lundsgaard
30-010065-12



Barken
30-010067-12



Scheie
30-010069-12



Burch
30-010071-12



30-010073-12



30-010075-12



30-010077-12



30-010079-12



30-010081-12



30-010083-12



Schweiz. Mod.
30-010085-12



30-010087-13



30-010089-13



Levinson
30-010091-13



Alvis
30-010093-12



Francis
30-010095-12



**La Force
(Golf-Club)**
30-010097-12



Davis
30-010099-13



Dix
30-010101-13



Ellis
30-010103-11



Plango
30-010105-12



Nicati
30-010107-12



Walton
30-010109-12



Walton
30-010111-12



Meyer
30-010113-12



Green
30-010115-13



Rollet
30-010117-12



Graefe
30-010119-13



Graefe
30-010121-13



Graefe
30-010123-13



**Becker
Malleable**
30-010125-13



Tuebingen
30-010127-13



Mod. Bonn
30-10129-14
14 cm/5½"



Hirschmann
Blunt
30-10132-10



Graefe
Sharp
30-10133-12



Graefe
Blunt
30-10136-12



Knolle
30-10140-01

◀ Blunt ▶



Jeffe-Knolle
30-10140-02



O'Connor
30-10144-12



Wiener

Sharp
30-10047-13

Blunt
30-10148-13



Hirschmann
30-10152-13



Graefe
30-10156-13



McGannan
30-10160-13
13 cm/5"



Meyer-Schwickerath
30-10164-13
13 cm/5"



Jaeger
30-10168-01



Jaeger
30-10168-02



Left Arruga
30-10172-01



Right
30-10172-02



Jameson
30-10176-12



Culler
30-10180-12



Green
30-10184-13



Guthrie
30-10188-12



Guthrie
30-10190-13



Berens
30-10194-12



**Knapp
Blunt**
30-10198-13



**Rollet
Sharp**
30-10201-12



**Rollet
Blunt**
30-10204-12



**Fink
Blunt**
30-10208-12



Right
30-10212-01

Left
30-10212-02

10.5 cm/4 1/4"



Knapp-Rollet
30-10216-02



Flexible
30-10216-03



Flexible
30-10216-04



Axenfeld

Sharp
30-10219-14

Blunt
30-10220-14



Axenfeld

Sharp
30-10223-14

Blunt
30-10224-14



Paul
30-10228-12



Sautter
30-10232-01



Sautter
30-10232-02



Sautter
30-10232-03



Arruga
30-10236-13



Stevens
30-10240-14



Stevens
30-10244-12



Graefe
30-10248-01



Graefe
30-10248-02



Graefe
30-10248-03



Wecker
30-10251-13



Wecker
30-10252-13



Stock
30-10255-13



Stock
30-10257-13



Culler
30-10262-13



Suker
30-10266-14

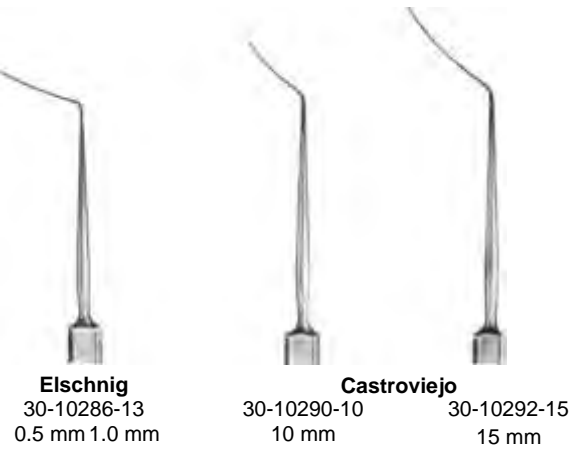
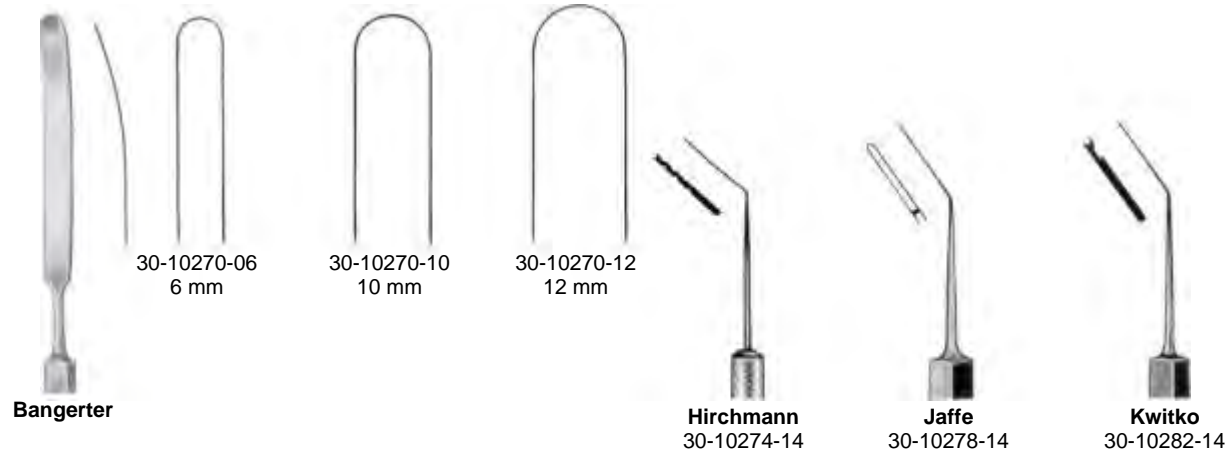

Width of Spatula

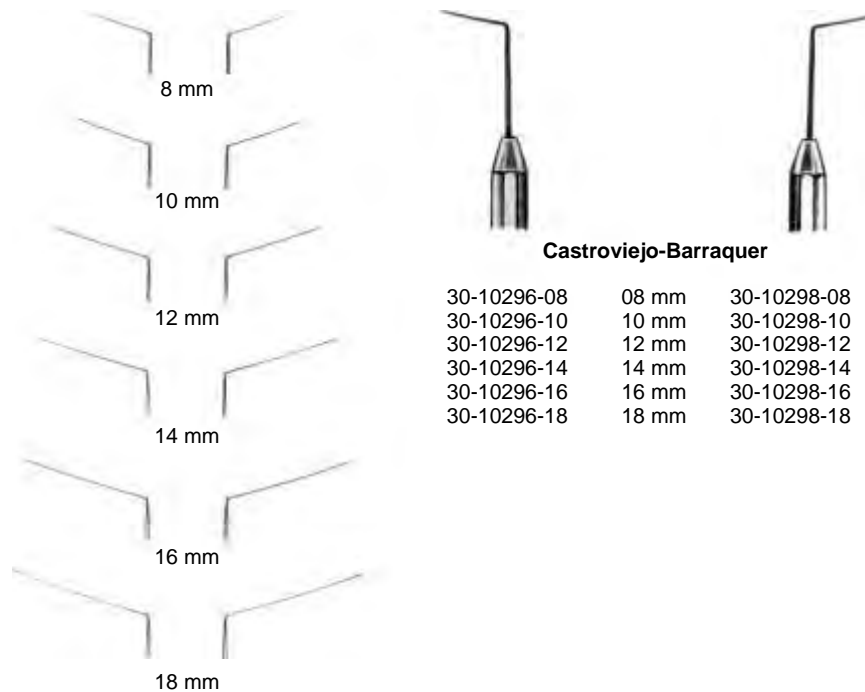





Enucleation Scoops

Small
30-10348-16

Large
30-10348-20

Wells

Chalazion Currettes



Meyhoefer

30-10352-05
0.5 mm Ø

30-10352-10
1.0 mm Ø

30-10352-15
1.5 mm Ø

30-10352-18
1.8 mm Ø

30-10352-20
2.0 mm Ø

30-10352-25
2.5 mm Ø

30-10352-35
3.5 mm Ø



Meyhoefer
30-10352-40
4.0 mm Ø

Meyhoefer
30-10352-45
4.5 mm Ø

30-10356-10
1.0 mm Ø

30-10356-20
2.0 mm Ø

Hebra
30-10356-25
2.5 mm Ø

30-10356-30
3.0 mm Ø

30-10356-35
3.5 mm Ø

Exenteration Scoops

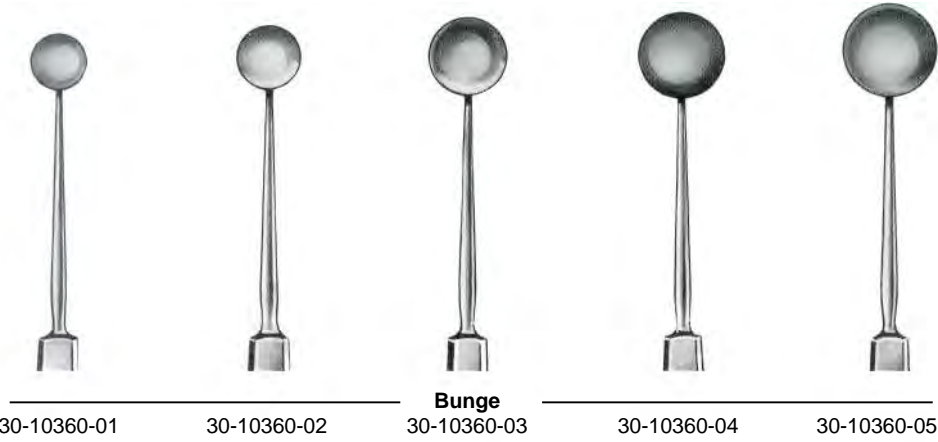

Chalazion Curette, Double

Axenfeld
30-10364-13
13 cm/5"



Lachrymal Sac Dissector

Lang
30-10368-13
13 cm/5"

Irrigating Cannulas

Straight



Binkhorst
30-10372-01
22 gauge

Right



Binkhorst
30-10372-02
22 gauge

Left



Binkhorst
30-10372-03
22 gauge

Probe Point



Bonn
30-10372-04
20 gauge



Bonn
30-10372-05
19 gauge



Hamburg
30-10372-06
23 gauge



Simcoe
30-10376-01
23 gauge

Irrigation/Aspiration Cannulas



Gills-Welsh
30-10376-02
25/23 gauge

Cystotome Cannulas



Knolle-Kelmann
30-10380-01
22 gauge



Neyvas
30-10380-02
22 gauge



Kratz
30-10380-03
22 gauge

Lens Manipulation Cannulas



Freeman
30-10384-01
27 gauge



Sheets
30-10388-01

Irrigating Vectis Cannulas



Knolle Pearce
30-10388-02



Simcoe
30-10388-03

Cortex Aspiration Cannulas



Simcoe
30-10392-01
23 gauge



Simcoe
30-10392-02
23 gauge

Capsule Polishing Cannulas

Posterior



Kratz
30-10396-01



Simcoe
30-10396-02



Jensen
30-10396-03

Lachrymal Cannulas



30-10400-01
25 gauge



30-10400-02
25 gauge



30-10400-03
25 gauge



30-10400-04
25 gauge



Bonn
30-10400-05
19 gauge



Bangerter
30-10400-06 40 mm
30-10401-06 60 mm



Anel
30-10400-07
23 gauge



Anel
30-10400-08
23 gauge

Alpha-Chymotrypsin Cannula



30-10404-00
23 gauge

Air Injection Cannula



Sauter
30-10406-00
27 gauge

Collar Button Cannulas



Straight
30-10408-01

Angled
30-10408-02

Graether

Knife Cannula



Sato
30-10408-03
23 gauge

A/C Puncture Cannula



Schreck
30-10408-04
21 gauge



Castroviejo
30-10412-15



Castroviejo
30-10412-20
20 mm



Holth
30-10416-01



Haitz
30-10416-02



West
30-10420-16
16 cm/6¼"



West
30-10422-16
16 cm/6¼"



Connin-Amsler
30-10426-13
13 cm/5"



Wilder
30-10430-01



Wilder
30-10430-02



Wilder
30-10430-03



Castroviejo
30-010434-12



Muldoon
30-10438-10



Simpson
30-10442-01



30-10446-01



Harms
30-10446-02

**Bowman
Fig.**

0000/0000	30-10450-04
000/000	30-10450-03
00/00	30-10450-02
0/0	30-10450-01
1/1	30-10450-11
2/2	30-10450-22
3/3	30-10450-33
4/4	30-10450-44
5/5	30-10450-55
6/6	30-10450-66
7/7	30-10450-77
8/8	30-10450-88



**Bowman
Fig.**

0000/000	30-10452-03
000/00	30-10452-02
00/0	30-10452-00
0/1	30-10452-01
1/2	30-10452-12
2/3	30-10452-23
3/4	30-10452-34
4/5	30-10452-45
5/6	30-10452-56
6/7	30-10452-67
7/8	30-10452-78



**Bowman
Fig.**

0000/000	30-10454-03
000/00	30-10454-02
00/0	30-10454-00
0/1	30-10454-01
1/2	30-10454-12
2/3	30-10454-23
3/4	30-10454-34
4/5	30-10454-45
5/6	30-10454-56
6/7	30-10454-67
7/8	30-10454-78



Martial: NS German Silver



Castroviejo
Width of Spatula

	mm
30-10458-05	0.50
30-10458-07	0.75
30-10458-10	1.00

Castroviejo



Castroviejo
30-10462-12



Wheeler
30-10466-12



Lindner
30-10470-13



Smith-Fisher
30-10474-12



Green
30-10478-12



Dix
30-10482-01



Dix
30-10482-02



Stille
30-10486-01



Stille
30-10486-02



30-10490-12

Ophthalmology Instruments Double-Ended Instruments and Instruments for D.B Kirby Operations



30-10494-13 30-10495-13

Needle Only
 30-10498-01

Chisel Only
 30-10498-02

Gouge Only
 30-10498-03



30-10500-13

Instrumentation for D. B. Kirby Operations



30-10502-10



Teeth
 30-10506-10 1:2 Teeth
 30-10508-10 2:3 Teeth



30-10510-10
 1 : 2



Kirby
 30-10514-10
 10 cm/4"



Kirby
 30-10516-10
 10 cm/4"



30-10520-10

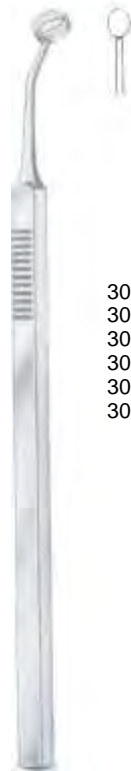

- 30-10524-01 =3.0 x 3.5 mm
- 30-10524-02 =3.0 x 4.0 mm
- 30-10524-03 =3.0 x 4.5 mm
- 30-10524-04 =3.5 x 4.0 mm
- 30-10524-05 =3.5 x 4.5 mm
- 30-10524-06 =3.5 x 5.0 mm

Bore's



- 30-10528-01 =2.75 mm
- 30-10528-02 =3.00 mm
- 30-10528-03 =3.25 mm
- 30-10528-04 =3.75 mm
- 30-10528-05 =4.00 mm
- 30-10528-06 =4.25 mm
- 30-10528-07 =4.50 mm
- 30-10528-08 =4.75 mm
- 30-10528-09 =5.00 mm
- 30-10528-10 =6.00 mm
- 30-10528-11 =8.00 mm

Bore's

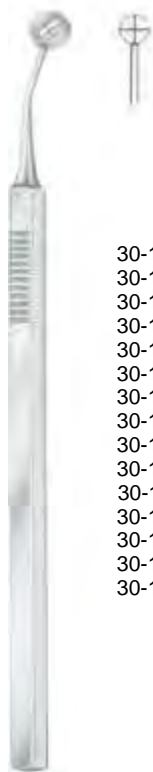

- 30-10532-01 =3.00 mm
- 30-10532-02 =3.25 mm
- 30-10532-03 =3.50 mm
- 30-10532-04 =3.75 mm
- 30-10532-05 =4.00 mm
- 30-10532-06 =4.25 mm
- 30-10532-07 =4.50 mm
- 30-10532-08 =4.75 mm
- 30-10532-09 =5.00 mm
- 30-10532-10 =5.50 mm
- 30-10532-11 =6.00 mm
- 30-10532-12 =7.00 mm
- 30-10532-13 =8.00 mm
- 30-10532-14 =9.00 mm
- 30-10532-15 =1.11 mm

Hoffer



- 30-10536-00
3 - 5 mm

Hoffer



- 30-10536-01
3 - 5 - 7 mm

- 30-10536-02
3 - 6 - 8 mm

Hoffer



Tuebingen
30-10540-10
10 cm/4"



30-10544-08
8.5 cm/3½"



Paufigue
30-10548-10
10 cm/4"



Barraquer
30-10552-10
10.5 cm/4¼"



McPherson
30-10556-10
10 cm/4"



McPherson
30-10560-07
7.5 cm/3"



McCullough
30-10564-09
9.5 cm/3 3/4"



McCullough
30-10568-09
9.5 cm/3 3/4"



Bonaccoito
30-10572-10
10 cm/4"



Bonaccoito
30-10576-10
10 cm/4"



30-10580-11
11 cm/4 1/2"



11 cm/4 1/2"

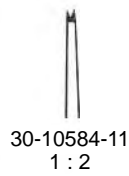

30-10584-11
1 : 2



30-10586-11
2 : 3



Nugent
10 cm/4"



30-10590-01



30-10590-02

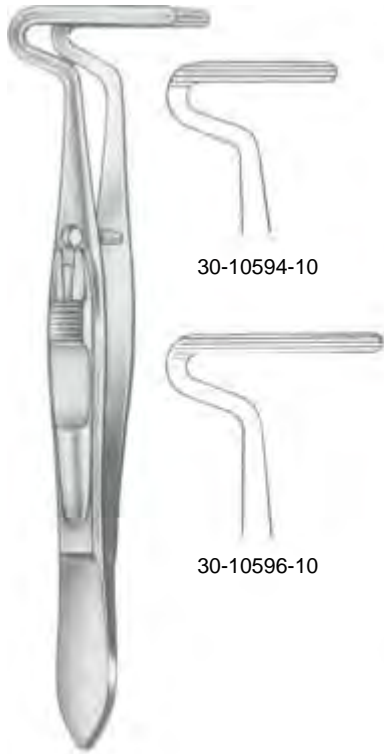

Berke
10 cm/4"



Blascovics
30-10600-09
9 cm/3½"



Blascovics
30-10601-09
9 cm/3½"



Worth
30-10604-10
10 cm/4"



Worth
30-10605-10
10 cm/4"



Jameson
30-10608-10
10 cm/4"



Jameson
30-10609-10
10 cm/4"



Prince
30-10612-10
10 cm/4"



Prince
30-10613-10
10 cm/4"



Sattler
30-10616-10
10 cm/4"



Sattler
30-10617-10
10 cm/4"



Snellen
30-10620-10
10 cm/4"



Snellen
30-10621-10
10 cm/4"



Erhardt
30-10624-09
9 cm/3½"



Barraquer
30-10628-05
5.5 cm/2¼"



Barraquer
30-10628-07
5.5 cm/2¼"



Barraquer
30-10628-10
5.5 cm/2¼"



Hess
30-10632-09
9 cm/3½"

◀ Swiss patterns ▶



Hess
30-10634-09
9 cm/3½"



10 x

With guide pin

1:2
Bonn
30-10638-07
7 cm/2¾"



10 x

Without guide pin

1:2
Bonn
30-10640-07
7 cm/2¾"



0.12 mm

Bonn
30-10642-10
10 cm/4"



Bishop-Harman
30-10646-08
8.5 cm/3½"



Bishop-Harman
30-10648-08
8.5 cm/3½"



Bishop-Harman
30-10650-08
8.5 cm/3½"



1:2
Bishop-Harman
30-10652-08
8.5 cm/3½"



Graefe
30-10656-05 0.5 mm
30-10656-07 0.7 mm
30-10656-10 1.0 mm
7 cm/2¾"



Graefe
30-10657-05 0.5 mm
30-10657-07 0.7 mm
30-10657-10 1.0 mm
7 cm/2¾"



1:2
Graefe
30-10660-05 0.5 mm
30-10660-07 0.7 mm
30-10660-10 1.0 mm
7 cm/2¾"



1:2
Graefe
30-10661-05 0.5 mm
30-10661-07 0.7 mm
30-10661-10 1.0 mm
7 cm/2¾"



Foerster
30-10664-08
8.5 cm/3½"



Foerster
30-10665-08
8.5 cm/3½"



1:2
Foerster
30-10668-08
8.5 cm/3½"



1:2
Foerster
30-10669-08
8.5 cm/3½"



Graefe
10 cm/4"



30-10672-10



30-10673-10



30-10675-10



30-10678-10



30-10679-10



30-10681-10

Conjunctival forceps



Stevens
10.5 cm/4 1/4"



30-10684-10



30-10685-10



30-10687-10



O'Connor
30-10696-10
10 cm/4"



30-10690-10



30-10691-10



30-10693-10



Stevens
30-10700-11
11 cm/4 1/2"



Stevens
30-10701-11
11 cm/4 1/2"



Fischer
30-10705-07
7 cm/2¾"



Fischer-Arit
30-10707-07
7 cm/2¾"



Hess
30-10711-07
7 cm/2¾"



Hess
30-10713-07
7 cm/2¾"



Smooth **Chandler** Serrated
30-10717-01 7 cm/2¾" 30-10717-02



Fuchs
30-10721-07
7 cm/2¾"



Gill-Hess
30-10723-07
7.5 cm/3"



Gill-Hess Teeth Below
30-10727-07 7.5 cm/3"
30-10729-07 Teeth on side



Barraquer-Katzin
(Colibri)
30-10733-07
7 cm/2¾"

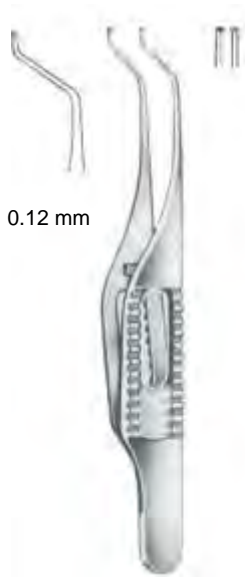

0.12 mm

Troutman (Colibri)
30-10737-07
7.5 cm/3"



0.12 mm

Barraquer (Colibri)
30-10739-07
7 cm/2¾"

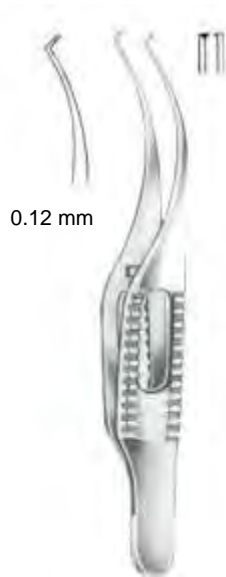

0.12 mm

Barraquer-Katzin (Colibri)
30-10741-07
7 cm/2¾"

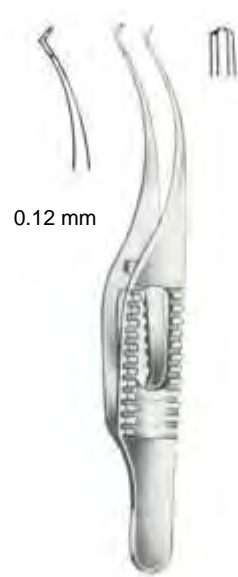

0.12 mm

Barraquer (Colibri)
30-10743-07
7 cm/2¾"



Gill-Arruga
30-10745-07
7.5 cm/3"



Terson
30-10749-09
9 cm/3½"



Schweigger
30-10753-10
10 cm/4"



Schweigger
30-10755-10
10 cm/4"



Elschnig
30-10759-10
10 cm/4"



Hess
30-10763-06
6 cm/2¼"



Hess
30-10765-06
6.5 cm/2½"



Fuchs
30-10771-07
7 cm/2¾"



Kalt
30-10775-10
10 cm/4"



Terson
30-10779-09
9.5 cm/3¾"



Arruga-Nizetic
30-10783-10
10 cm/4"



Castroviejo
30-10787-10
10 cm/4"



Castroviejo
30-10789-10
10 cm/4"



Elschnig
30-10793-10
10 cm/4"

For Len Implantation



Binkhorst
30-10797-07
7 cm/2¾"



Arruga
30-10801-09
9.5 cm/3¾"



Arruga
30-10803-09
9.5 cm/3¾"



Shepard

With irrigator
30-10807-01

Without irrigator
30-10807-02



Dastoor
30-10811-06
6 cm/2 1/4"



Arruga
30-10815-10
10 cm/4"

Calibrated
Arruga
30-10817-10
10 cm/4"



Arruga
30-10819-10
10 cm/4"

Calibrated
Arruga-Elschnig
30-10821-10
10 cm/4"



Knapp
30-10824-11
11 cm/4¼"



Ayer
30-10828-09
9 cm/3½"



Ayer
30-10830-09
9 cm/3½"



Lambert
30-10834-09
9 cm/3½"



Desmarres
9 cm/3½"



30-10838-01



30-10838-02



30-10838-03

Corneal Fixation Forceps

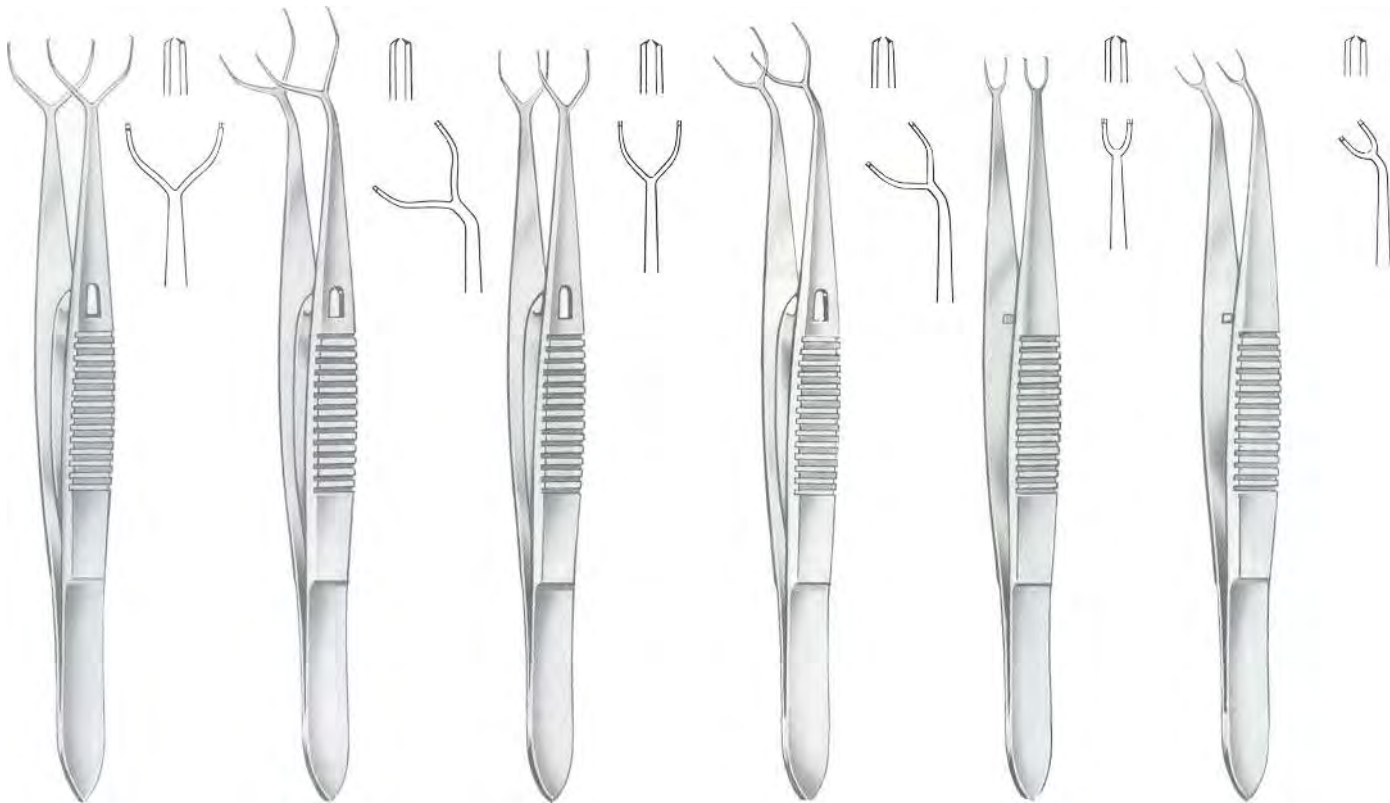

Kremer
30-10842-10
10 cm/4"
0.12 mm

Kremer
30-10843-10
10 cm/4"
0.12 mm

Arrowsmith
30-10848-10
10 cm/4"
0.12 mm

Arrowsmith
30-10849-10
10 cm/4"
0.12 mm

Bores
30-10852-10
10 cm/4"
0.12 mm

Rubman-Bores
30-10853-10
10 cm/4"
0.12 mm



Without Spring Catch
30-10858-11

Graefe
11 cm/4½"



2 : 3 Teeth

30-10864-11
11 cm/4½"



3 : 4 Teeth

30-10866-11
11 cm/4½"



Castroviejo
30-10870-09
9 cm/3½"



Castroviejo
30-10872-09
9 cm/3½"



Moorfield
30-10876-10
10 cm/4"



Lester
30-10880-02 1 : 2
30-10882-03 2 : 3
9 cm/3½"



Castroviejo
10 cm/4"

Straight
30-10886-01
30-10886-02
30-10886-03
30-10886-04
30-10886-05

Width of Teeth
0.12 mm
0.30 mm
0.50 mm
1.00 mm
1.05 mm

Curved
30-10887-01
30-10887-02
30-10887-03
30-10887-04
30-10887-05



Castroviejo
10 cm/4"



Castroviejo
30-10890-09
9 cm/3½"



St. Martin
30-10894-07
7 cm/2 3/4"



Elschnig
30-10898-11
11.5 cm/4 1/2"



Elschnig
30-10900-11
11.5 cm/4 1/2"



Barraquer
30-10904-10
10 cm/4"



Green
10 cm/4"

Wide
05 mm
10 mm

Without Spring Catch
30-10908-05
30-10908-10

Wide
05 mm
10 mm

With Spring Catch
30-10910-05
30-10910-10



30-10913-12
12 cm/4 3/4"



30-10914-12
12 cm/4 3/4"



Woodruff
30-10918-13
13 cm/5"



Woodruff
30-10920-13
13 cm/5"



Jacobi
30-10924-14
14 cm/5½"

Hook Handle



Gigli
31-10928-00

Wire Saws



Gigli
31-10932-30 30 cm/12"
31-10932-40 40 cm/16"
31-10932-50 50 cm/20"

Conductors



Martel
31-10936-33
33 cm/13"

With 2 Extra Hooks

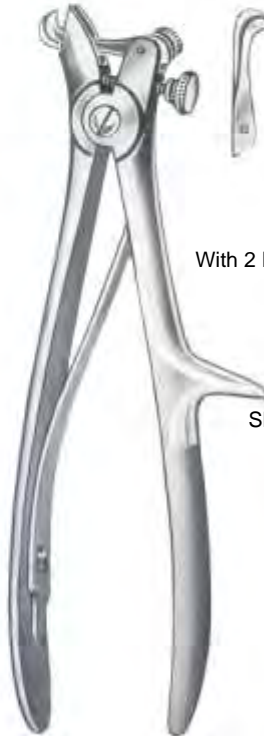

Dahlgren
31-10940-20
20 cm/8"

Skull Cutting Forceps

With 1 Hook Each

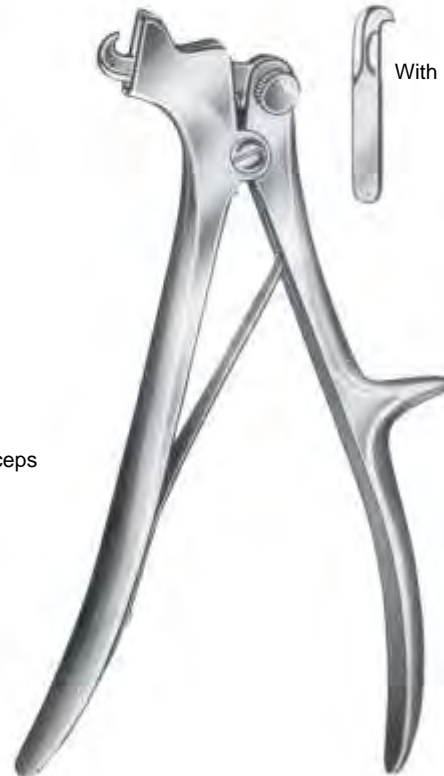

De Vilbiss
31-10944-21
21 cm/8¼"



Crutchfield
31-10948-00



Crutchfield
31-10952-00



31-10956-00



Crutchfield
31-10960-00
Complete With 2 Drills

Applying and Removing Forceps



Raney
31-10964-00
16 cm/6¼"



McKenzie
31-10968-15 15 cm/6"
31-10968-19 19 cm/7½"



Olivecrona-Tonnis
31-10972-14

Medial



mm
31-10976-40 40 x 20
31-10976-45 45 x 20
31-10976-50 50 x 20
31-10976-55 55 x 20
31-10976-60 60 x 20

Lateral



mm
31-10978-40 40 x 20
31-10978-45 45 x 20
31-10978-50 50 x 20
31-10978-55 55 x 20
31-10978-60 60 x 20



mm
31-10980-40 40 x 20
31-10980-45 45 x 20
31-10980-50 50 x 20
31-10980-55 55 x 20
31-10980-60 60 x 20



Blunt Blades, For Taking
mm
31-10982-50 50 x 25
31-10982-60 60 x 25



mm
31-10984-35 35 x 52
31-10984-40 40 x 52
31-10984-45 45 x 52
31-10984-50 50 x 52
31-10984-55 55 x 52
31-10984-60 60 x 52
31-10984-65 65 x 52
31-10984-70 70 x 52



mm
31-10986-35 35 x 37
31-10986-40 40 x 37
31-10986-45 45 x 37
31-10986-50 50 x 37
31-10986-55 55 x 37
31-10986-60 60 x 37
31-10986-65 65 x 37
31-10986-70 70 x 37



mm
31-10988-35 35 x 22
31-10988-40 40 x 22
31-10988-45 45 x 22
31-10988-50 50 x 22
31-10988-55 55 x 22
31-10988-60 60 x 22
31-10988-65 65 x 22
31-10988-70 70 x 22



mm
31-10990-50 50

Hook



mm
31-10992-70 70

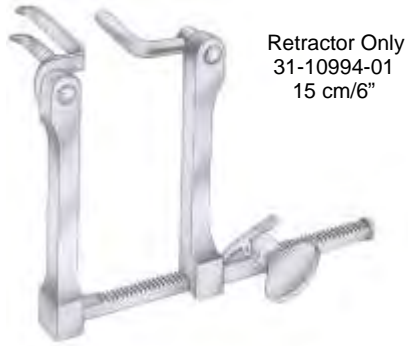

Retractor Only
31-10994-01
15 cm/6"

Caspar
31-10994-00

Retractor Complete With
1 Blade Each
31-10988-40
31-10990-50

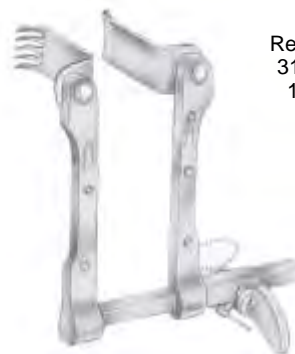

Retractor Only
31-10998-01
12 cm/4 3/4"

Caspar
31-10998-00

Retractor Complete With
1 Blade Each
31-10976-40
31-10978-40

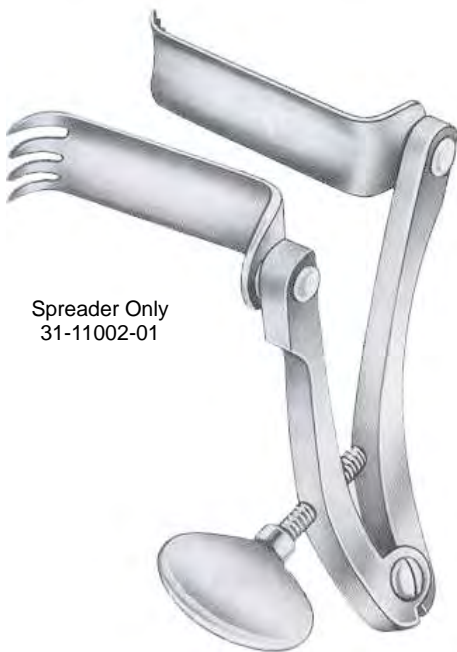

Spreader Only
31-11002-01

Caspar
31-11002-00
Retractors Only
Spreader Complete With
1 Blade Each
31-11976-45
31-11976-60

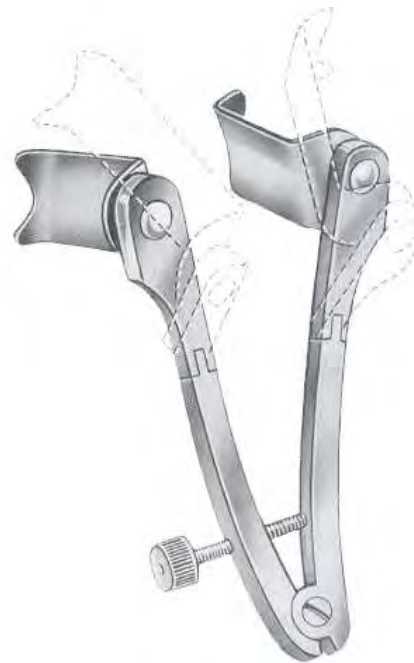

Spreader Only
31-11006-01

Caspar
31-11006-00
Spreader Only
Retractor Complete With
1 Blade Each
31-11980-40
31-11980-60

31-11010-01
15 cm/6"
Retractor only

Caspar
31-11010-00
31-10980-45
31-10980-65
Retractor complete with
1 blade each



31-11014-01
15 cm/6"
Retractor only

Caspar
31-11014-00
31-10980-45
31-10980-65
Retractor adjustable, con
1 blade each



31-11018-01
Retractor only
with 1 fixed blade

Caspar
31-11018-00
Retractor complete,
eith 5 blades

31-11018-40
40 mm



31-11018-45
45 mm



31-11018-50
50 mm



31-11018-55
55 mm



31-11018-60
60 mm





31-11022-01
Retractor only

Cloward
31-11022-00
25 cm/10"
complete with 5 blades



31-11022-40
15x40 mm

31-11022-45
15x45 mm

31-11022-50
15x50 mm

31-11022-55
15x55 mm

31-11022-60
15x60 mm



31-11026-01
Retractor only

Cloward
31-11026-00
15 cm/6"
complete with 5 blades



31-11026-40
15x40 mm

31-11026-45
15x45 mm

31-11026-50
15x50 mm

31-11026-55
15x55 mm

31-11026-60
15x60 mm



Inge
31-11030-16
16 cm/6¼"



Inge
31-11032-25
27 cm/10¾"



Cloward
31-11036-15
15 cm/6"



Cloward
31-11040-16
16 cm/6¼"

Muscle blades



Frame
31-11044-01

Hey
31-11044-00
31-11046-00
23 cm/9"



31-11044-50
20x50 mm



31-11044-60
20x60 mm



31-11044-70
20x70 mm

Vertebra-pins



31-11046-50
50 mm



31-11046-60
60 mm



31-11046-70
70 mm



	Left-type	Right-type
50x10 mm	31-11050-01	31-11052-01
60x10 mm	31-11050-02	31-11052-02
70x10 mm	31-11050-03	31-11052-03
50x20 mm	31-11054-01	31-11056-01
60x20 mm	31-11054-02	31-11056-02
70x20 mm	31-11054-03	31-11056-03

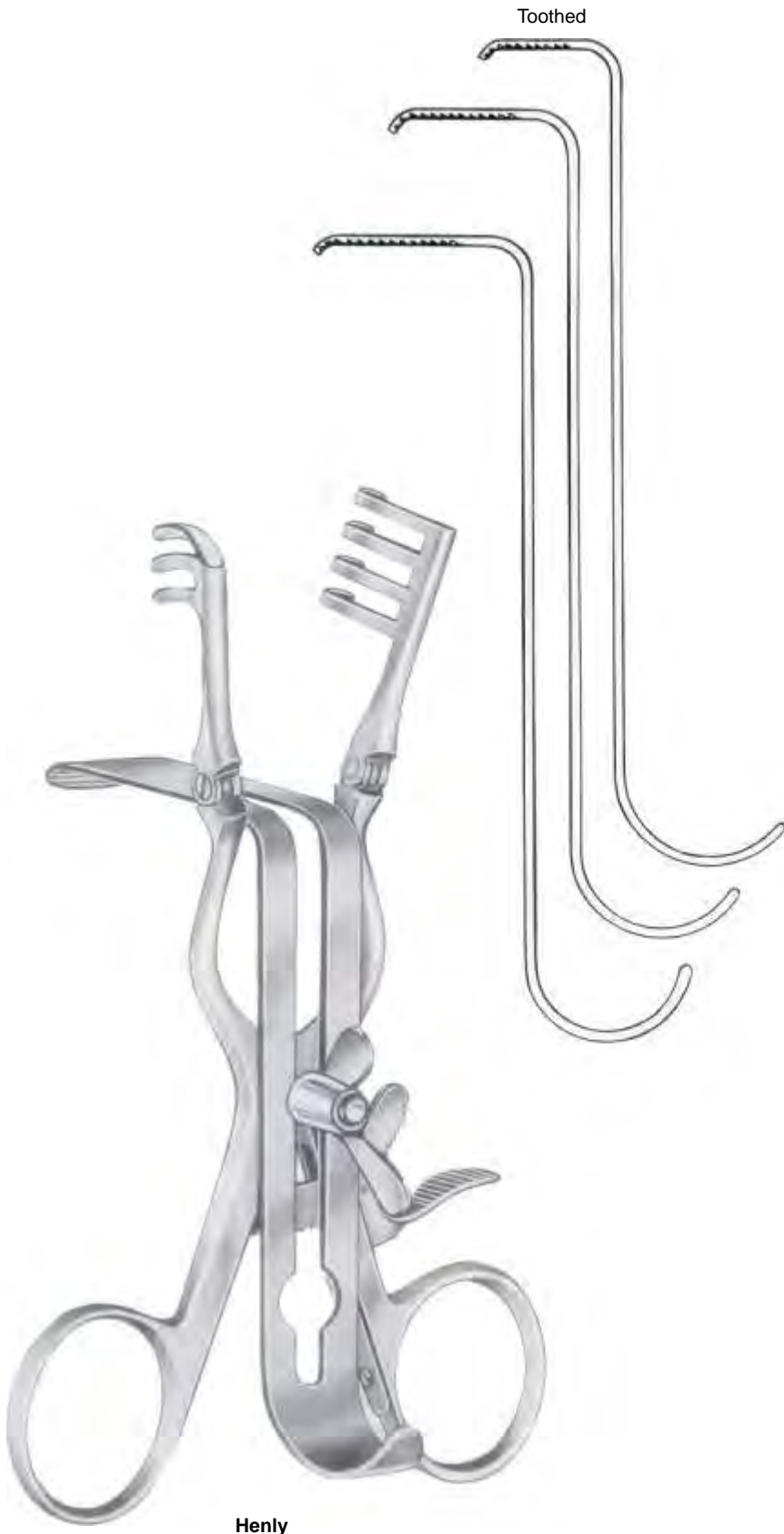

Henly

Toothed

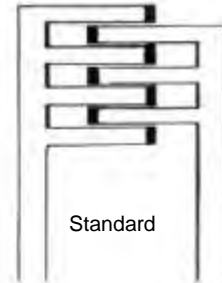

Standard

31-11060-00 Complete 31-11062-00
14.5 cm/5¾" Consisting of 17 cm/6¾"

31-11060-01 Frame 31-11062-01
31-11060-21 Centre Blades 31-11060-21
31-11060-22 31-11060-22
31-11060-23 31-11060-23

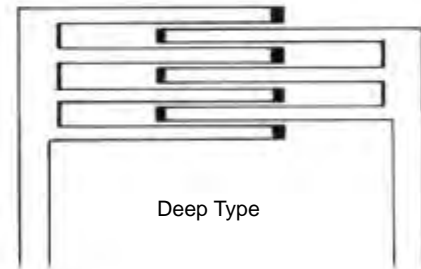

Deep Type

31-11064-00 Complete 31-11066-00
14.5 cm/5¾" Consisting of 17 cm/6¾"

31-11060-01 Centre Blades 31-11066-01
31-11060-21 31-11060-21
31-11060-22 31-11060-22
31-11060-23 31-11060-23



Davis
31-11070-24
24.5 cm/9 3/4"



Toennis
31-11074-25
25 cm/10"



Frazier
31-11078-15



Hoens
31-11080-15



Hoens
31-11082-15

15 cm/6"



Love-Adson
31-11086-16
16 cm/6 1/2"

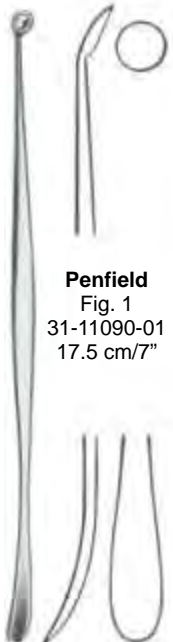

Penfield
Fig. 1
31-11090-01
17.5 cm/7"



Penfield
Fig. 2
31-11090-02
19.5 cm/7 3/4"

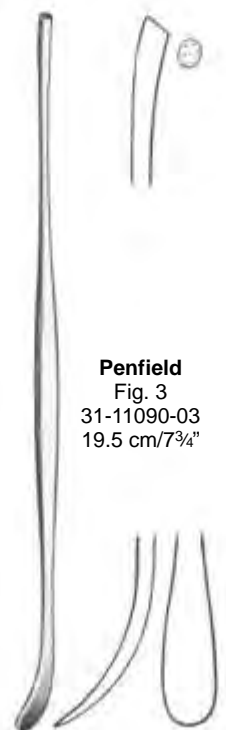

Penfield
Fig. 3
31-11090-03
19.5 cm/7 3/4"



Penfield
Fig. 4
31-11090-04
21.5 cm/8 1/2"



Penfield
Fig. 5
31-11090-05
29 cm/11 1/2"



Sachs
31-11094-21
21 cm/8¼"

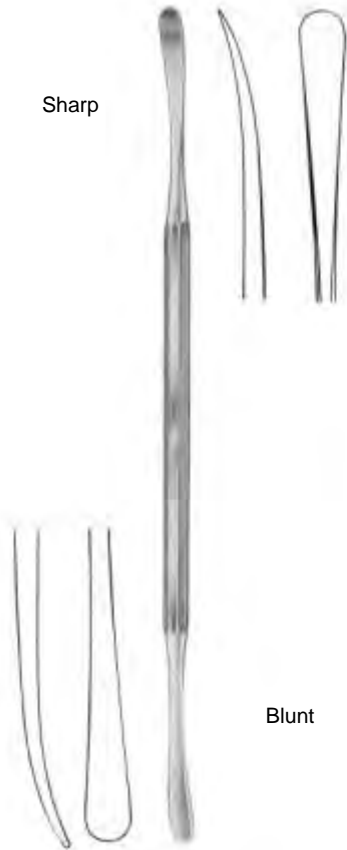

Sharp

Blunt

31-11098-22
22 cm/8¼"



Woodsen
31-11102-25
25 cm/10"



Fragner
31-11106-20
20 cm/8"



Fragner
31-11108-20
20 cm/8"



Sachs
31-11112-21
21 cm/8¼"



Milligan
31-11116-21
21 cm/8¼"



Olivecrona
31-11120-18 18 cm/7"
31-11120-24 24 cm/9½"



Olivecrona
31-11124-19 19.5 cm/7¾"
31-11124-24 24 cm/9½"



Horsley
31-11128-20
20 cm/8"



Sachs
31-11132-21
21 cm/8¼"



Cushing
17 cm/6³/₄"
20 cm/8"
28 cm/11"

31-11136-17
31-11136-20
31-11136-28

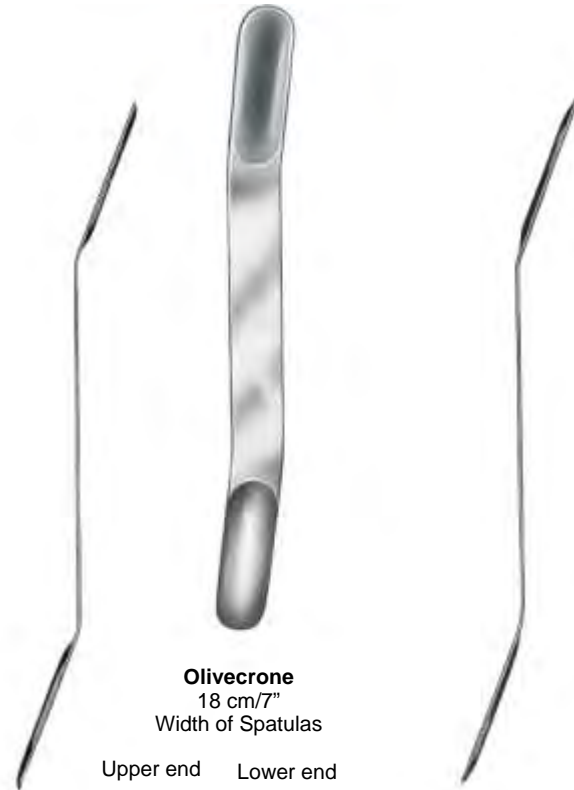

Olivecrona
18 cm/7"
Width of Spatulas

	Upper end		Lower end	
	Concave	mm	mm	Convex
31-11140-01		7	9	31-11142-01
31-11140-02		11	13	31-11142-02
31-11140-03		15	18	31-11142-03
31-11140-04		18	22	31-11142-04



Heifetz
20 cm/8"

Width of Spatulas

Upper end		Lower end
mm		mm
7	31-11144-08	8
10	31-11144-11	11
13	31-11144-13	14
16	31-11144-17	17
19	31-11144-20	20
22	31-11144-25	22



Heifetz
15.5 cm/6"

Width of Spatulas

31-11148-08	8
31-11148-11	11
31-11148-13	14
31-11148-17	17

Length of Spatulas



18 cm/7"

Width of spatulas

Upper end		Lower end	
mm	mm		
7	9	31-11152-09	
11	13	31-11152-13	
15	18	31-11152-18	
18	22	31-11152-22	



20 cm/8"
12 mm 31-11156-12
17 mm 31-11156-17



20 cm/8"
14 mm 31-11160-14
17 mm 31-11160-17
20 mm 31-11160-20



31-11164-01
19cm/7½"



Love
31-11164-02
19 cm/7½"



31-11164-03



Love
31-11168-21
21 cm/8¼"

Length of spatulas



70 mm
3 mm 31-11172-03

100 mm
31-11174-03



5 mm 31-11172-05

31-11174-05



7 mm 31-11172-07

31-11174-07



Love

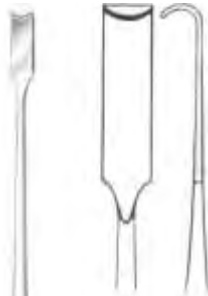

Scoville
23 cm/9"

7 mm 31-11176-07
9 mm 31-11176-09

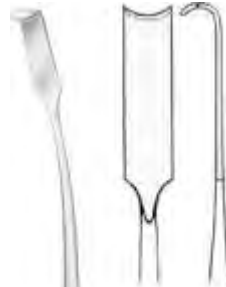

Holsher
7mm 31-11177-07
9mm 31-11177-09
24 cm/9½"



8 mm 31-11179-08
13 mm 31-11179-13



Taylor

30x 70 mm 31-11180-07 17 cm/6¾"
30x100 mm 31-11180-10 17 cm/6¾"



Oldberg

21 cm/8¼"



31-11182-01



31-11182-02



31-11182-03



31-11182-04



Cushing

31-11184-19 19 cm/7¾"
31-11184-28 28 cm/11"



Smithwick

31-11188-17 17 cm/6½"
31-11188-21 21 cm/8¼"



Cushnig

31-11190-14
14 cm/5½"



Adson

20 cm/8"



31-11192-01



31-11192-02



Cloward
31-11196-16
16 cm/6½"



Hoehn
31-11200-22
22 cm/8¾"



Dandy
31-11204-01
20 cm/8"



Dandy
31-11204-02
20 cm/8"



Dandy
31-11204-03
20 cm/8"



Smithwick
31-11208-29
29 cm/11¾"



Scoville
31-11212-30
30 cm/12"



Scoville
31-11214-30
30 cm/12"



Graham
31-11218-16
16.5 cm/6½"



Toennis
31-11222-15
15 cm/6"



Frazier
31-11226-13 13 cm/5"
31-11226-18 18 cm/7"



Toennis
31-11230-13 13 cm/5"
31-11230-18 18 cm/7"





Olivecrona
31-11234-23
23 cm/9"



Olivecrona
31-11236-20
20.5 cm/8"





Ferris-Smith-Kerrison

		Width of Bite	Length of Shaft		
			15 cm/6"	20 cm/8"	
Cutting Upward		0.6 mm			31-11252-00
		1 mm			31-11252-01
		2 mm			31-11252-02
		3 mm	31-11240-03	31-11246-03	31-11252-03
		4 mm			31-11252-04
		5 mm	31-11240-05	31-11246-05	31-11252-05
Cutting Upward 40°		0.6 mm			31-11254-00
		1 mm			31-11254-01
		2 mm			31-11254-02
		3 mm	31-11242-03	31-11248-03	31-11254-03
		4 mm			31-11254-04
		5 mm	31-11242-05	31-11248-05	31-11254-05
Cutting Downwards		0.6 mm			31-11256-00
		1 mm			31-11256-01
		2 mm			31-11256-02
		3 mm	31-11244-03	31-11250-03	31-11256-03
		4 mm			31-11256-04
		5 mm	31-11244-05	31-11250-05	31-11256-05







Ferris-Smith-Kerrison

		Width of Bite		Length of Shaft		
		3 mm	5 mm	15 cm/6"	20 cm/8"	18 cm/7"
Cutting Upward		31-11260-03	31-11260-05	31-11266-03	31-11266-05	31-11272-03 31-11272-05
Cutting Upward 40°		31-11262-03	31-11262-05	31-11268-03	31-11268-05	
Cutting Downward		31-11264-03	31-11264-05	31-11270-03	31-11270-05	31-11274-03 31-11274-05





Love-Kerrison

		Width of Bite		Length of Shaft		
		2 mm	3 mm	15 cm/6"	20 cm/8"	18 cm/7"
Cutting Upward		2 mm				31-11286-02
		3 mm	31-11278-03	31-11282-03		31-11286-03
		4 mm	31-11278-04	31-11282-04		31-11286-04
		5 mm	31-11278-05	31-11282-05		31-11286-05
		6 mm				31-11286-06
Cutting Upward 40°		2 mm				31-11288-02
		3 mm				31-11288-03
		4 mm				31-11288-04
		5 mm				31-11288-05
		6 mm				31-11288-06
Cutting Downward		2 mm				31-11290-02
		3 mm	31-11280-03	31-11284-03		31-11290-03
		4 mm	31-11280-04	31-11284-04		31-11290-04
		5 mm	31-11280-05	31-11284-05		31-11290-05
		6 mm				31-11290-06
Cutting Upward 40°		2 mm				31-11292-02
		3 mm				31-11292-03
		4 mm				31-11292-04
		5 mm				31-11292-05
		6 mm				31-11292-06



Colclough

		Width of Bite	Length of Shaft	
			15 cm/6"	20 cm/8"
Cutting Upward		3 mm	31-11296-03	31-11302-03
		5 mm	31-11296-05	31-11302-05
Cutting Upward 40°		3 mm	31-11298-03	31-11304-03
		5 mm	31-11298-05	31-11304-05
Cutting Downward		3 mm	31-11300-03	31-11306-03
		5 mm	31-11300-05	31-11306-05



	Length Of Shaft			
Cushing 2 x 10 cm	5"/13 cm	31-11310-01	31-11310-02	31-11310-03
	6"/15 cm	31-11312-01	31-11312-02	31-11312-03
	7"/18 cm	31-11314-01	31-11314-02	31-11314-03
Love-Grunwald 3 x 10 cm	5"/13 cm	31-11316-01	31-11316-02	31-11316-03
	6"/15 cm	31-11318-01	31-11318-02	31-11318-03
	7"/18 cm	31-11320-01	31-11320-02	31-11320-03
Spurling 4 x 10 cm	5"/13 cm	31-11322-01	31-11322-02	31-11322-03
	6"/15 cm	31-11324-01	31-11324-02	31-11324-03
	7"/18 cm	31-11326-01	31-11326-02	31-11326-03



	Length Of Shatt			
Cushing 2 x 10 cm	5"/13 cm	31-11330-01	31-11330-02	31-11330-03
	6"/15 cm	31-11332-01	31-11332-02	31-11332-03
	7"/18 cm	31-11334-01	31-11334-02	31-11334-03
Love-Grunwald 3 x 10 cm	5"/13 cm	31-11336-01	31-11336-02	31-11336-03
	6"/15 cm	31-11338-01	31-11338-02	31-11338-03
	7"/18 cm	31-11340-01	31-11340-02	31-11340-03
Spurling 4 x 10 cm	5"/13 cm	31-11342-01	31-11342-02	31-11342-03
	6"/15 cm	31-11344-01	31-11344-02	31-11344-03
	7"/18 cm	31-11346-01	31-11346-02	31-11346-03

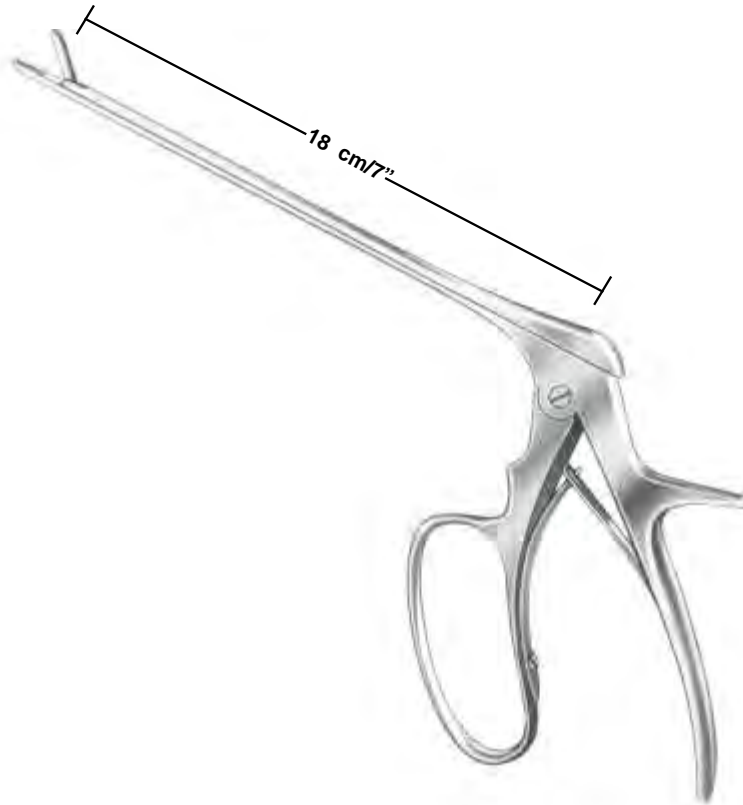

Ferris-Smith

Width Of Jaw



2 x 10 mm	31-11350-01	31-11350-02	31-11350-03
3 x 10 mm	31-11352-01	31-11352-02	31-11352-03
4 x 10 mm	31-11354-01	31-11354-02	31-11354-03



Serrated and Fenestrated Jaws

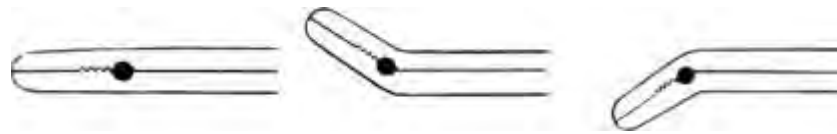

Width Of Jaw	Length Of Shaft			
mm	14 cm/5 1/2"	31-11358-01	31-11358-02	31-11358-03
2 x 12	16 cm/6 1/4"	31-11360-01	31-11360-02	31-11360-03
	14 cm/5 1/2"	31-11362-01	31-11362-02	31-11362-03
3 x 12	16 cm/6 1/4"	31-11364-01	31-11364-02	31-11364-03
	14 cm/5 1/2"	31-11366-01	31-11366-02	31-11366-03
4 x 14	16 cm/6 1/4"	31-11368-01	31-11368-02	31-11368-03
	14 cm/5 1/2"	31-11370-01	31-11370-02	31-11370-03
5 x 14	16 cm/6 1/4"	31-11372-01	31-11372-02	31-11372-03
	14 cm/5 1/2"	31-11374-01	31-11374-02	31-11374-03
6 x 16	16 cm/6 1/4"	31-11376-01	31-11376-02	31-11376-03

Serrated Jaws

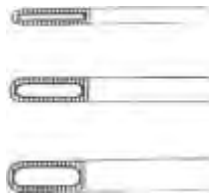

		mm	
31-11378-02	2 x 10	13 cm/5"	
31-11378-03	3 x 10	13 cm/5"	
31-11378-04	4 x 10	13 cm/5"	

Length Of Shaft

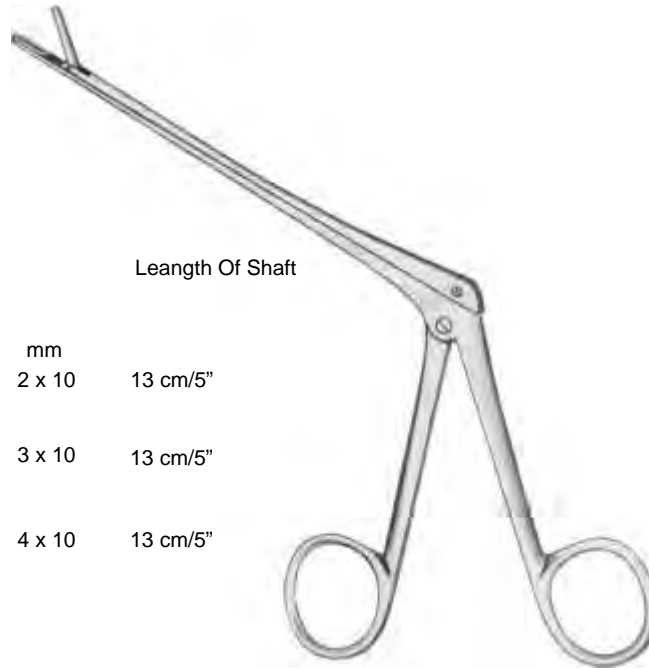

Schlessinger

Grasping Forceps

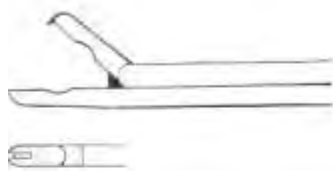

31-11382-16

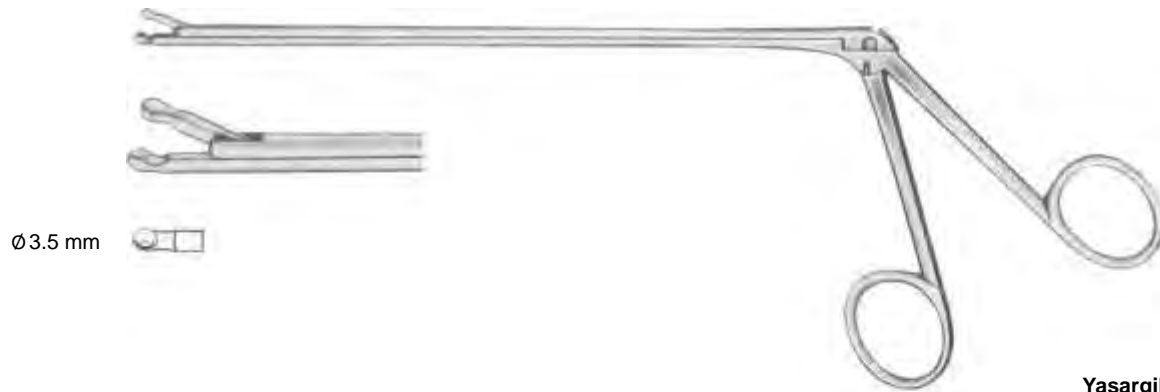

Yasargil
31-11386-35
19.5 cm/7 3/4"



Oldberg
31-11390-65
18 cm/7"



Landolt
31-11392-90
21 cm/8 1/4"
Tumor Grasping Forceps Blunt

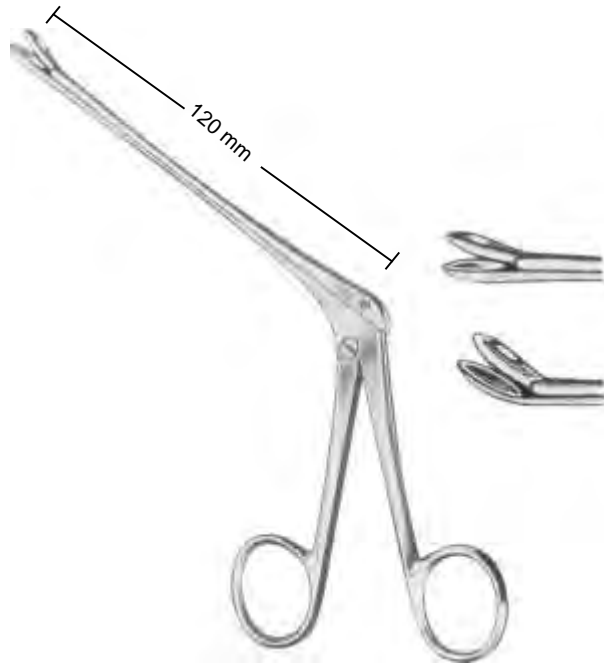

Weil-Blakesley



31-11396-01



31-11396-02



31-11396-03



31-11396-04



31-11396-05



31-11398-01

31-11398-02

31-11398-03

31-11398-04

31-11398-05



31-11402-01



31-11402-02



31-11402-03



31-11402-04



31-11402-05



31-11404-01

31-11404-02

31-11404-03

31-11404-04

31-11404-05

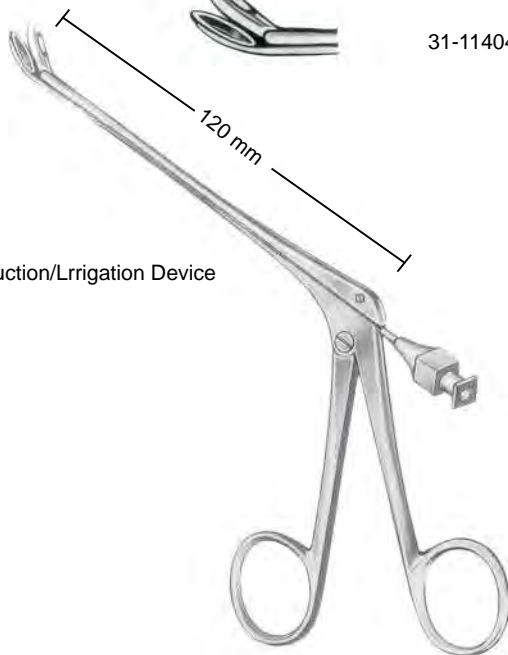





With Suction/Irrigation Device

Weil-Blakesley



Hajek
(Hajek-Kofler)
14 cm/5½"

-  31-11408-01
5 x 4 mm
-  31-11408-02
5 x 4 mm
-  31-11408-03
5 x 3.5 mm
-  31-11408-04
5 x 3.5 mm



Hajek-Kofler
31-11412-16
16 cm/6½"

360° Turnable

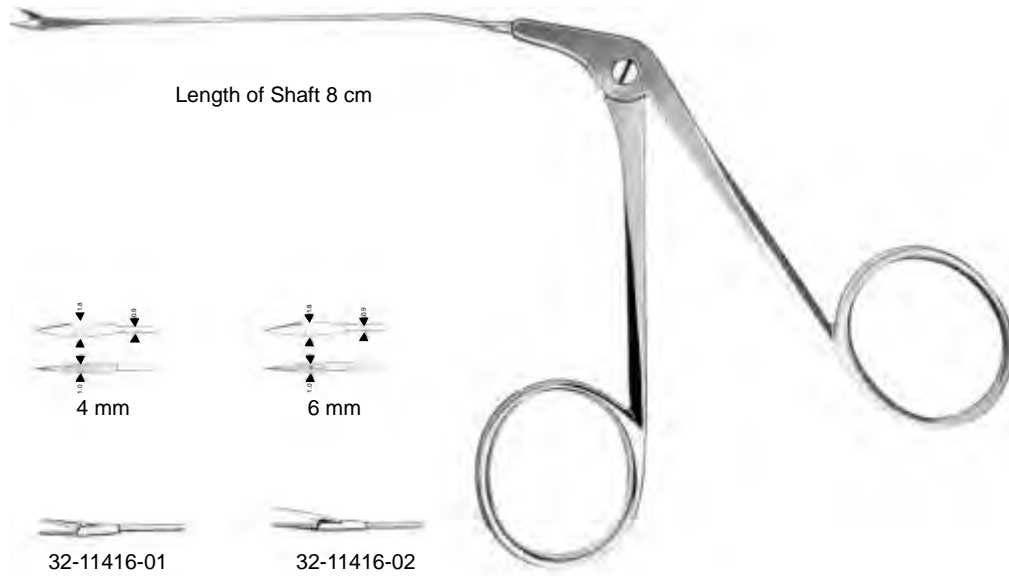

Micro Forceps

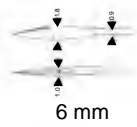
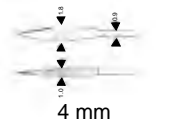

Straight

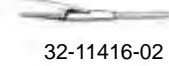
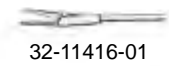

Angled Up



Straight

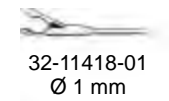

Oval Cup Jaws

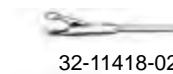

Micro Scissors

Straight

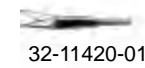

Angled Up



Curved Right

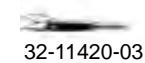

Curved Left

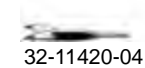

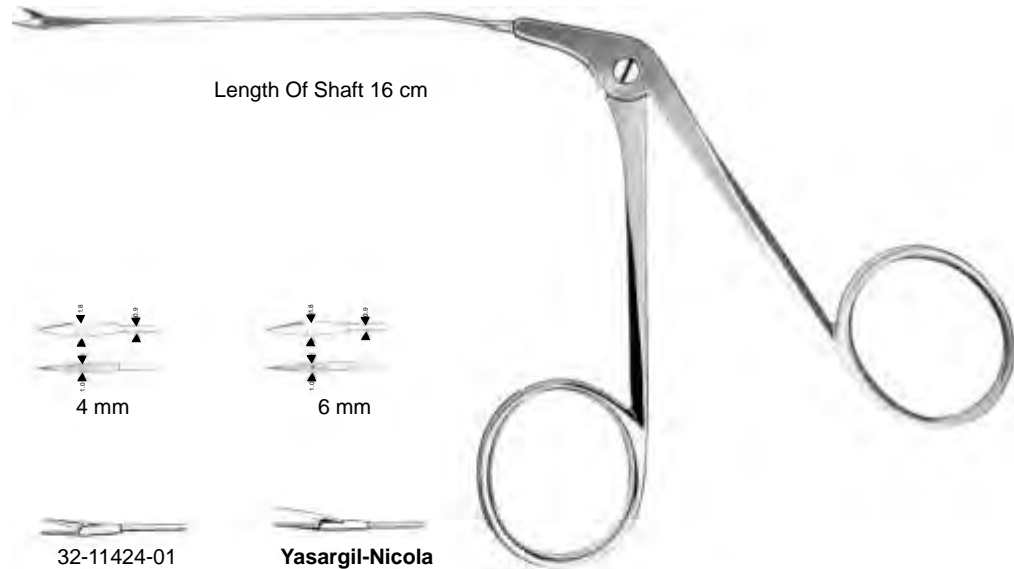

Micro Forceps

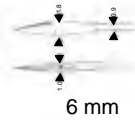
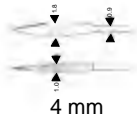

Straight

32-11424-01

Yasargil-Nicola
32-11424-02

Angled Up

32-11424-03

Cup-Shaped Forceps

Straight

32-11426-01
Ø 01 mm
32-11426-02
Ø 25 mm

Oval Cup Jaws

32-11426-03

Micro Forceps

Straight

Nicola
32-11428-01

Angled Up

Fahlbusch
32-11428-02

Curved Right

32-11428-03

Curved Left

32-11428-04

Micro Scissors

Length of Shaft 14 cm



Straight
32-11430-01



Curved Right
32-11430-02



Curved Left
32-11430-03



Jacobson
32-11432-00
18.5 cm/7¼"



Koos
32-11432-01
18.5 cm/7¼"



Koos
32-11432-02
18.5 cm/7¼"



Koos
32-11432-03
18.5 cm/7¼"



Koos
32-11432-04
18.5 cm/7¼"



Koos
32-11434-01
18.5 cm/7¼"



Koos
32-11434-02
18.5 cm/7¼"



Yasargil
32-11434-03
18.5 cm/7¼"



Yasargil
32-11434-04
18.5 cm/7¼"





32-11444-01
18.5 cm/7¼"



32-11444-02
18.5 cm/7¼"



krayenbuhl
32-11448-01
18.5 cm/7¼"



32-11448-02



32-11448-03



32-11448-04



Yasargil
32-11450-01
18.5 cm/7¼"



Yasargil
32-11450-02
18.5 cm/7¼"



Yasargil
32-11450-03
18.5 cm/7¼"



Yasargil
32-11450-04
18.5 cm/7¼"



Tissue Pick
32-11454-11
11 cm/4 1/8"

Tissue Pick
32-11456-10 1.0 mm
32-11456-18 1.8 mm
18.5 cm/7 1/4"

Vessel Dilator
32-11460-05 0.5 mm
32-11460-10 1.0 mm
32-11460-15 1.5 mm
12.5 cm/5"

Jacobson
Probe
32-11464-01
18.5 cm/7 1/4"

Vessel Probe
32-11464-02

Suture Pusher
32-11464-03



Rhoton
19 cm/7½"



Dissector Round
32-11470-01
Ø 1 mm



Dissector Round
32-11470-02
Ø 2 mm



Dissector Round
32-11470-03
Ø 3 mm



Dissector Spatula Shaped
32-11470-04
Ø 1 mm



Dissector Spatula Shaped
32-11470-05
Ø 1.5 mm



Dissector Spatula Shaped
32-11470-06
Ø 2.0 mm



Elevator
32-11470-07
Ø 1.2 mm



Elevator
32-11470-08
Ø 2.8 mm



Needle Semi-Sharp
32-11470-09



Hook Blunt
32-11470-10
90° 2 mm



Hook Semi-Sharp
32-11470-11
90° 2 mm



Hook Semi-Sharp
32-11470-12
45° 3 mm



Probe Angled
32-11470-13
90°



Probe Angled
32-11470-14
1.0 x 2.0 mm



Probe Angled
32-11470-15
1.0 x 2.0 mm
45°



Jannetta
19 cm/7½"



Dissector, Small
32-11474-01



Dissector, large
32-11474-02



Raspatory
32-11474-03



Hook, Small
32-11474-04
90°



Hook Medium
32-1474-05
90°



Hook large
32-1474-06
90°



Hook Angular
32-1474-07
45°



Hook Medium
32-1474-08
45°



Elevator Angula
32-1474-09



Knife Hollow Small
32-1474-10



Knife Hollow Large
32-1474-11



Probe ball-tipped
32-1474-12



Ligature Carrier left
32-11474-13



Ligature Carrier right
32-11474-14



Fork Small
32-11474-15
30°



Fork Large
Probe Ball-Tipped
32-11474-16
30°



19 cm/7 1/2"



Micro Dissectors
32-11478-01
2 mm



32-11478-02
5mm



32-11478-03
8mm

Nerve Hooks



32-11478-04
3mm



32-11478-05
5mm

Micro Ligature Needle



Samil
20 cm/8"
23 cm/9"



32-11482-01
32-11484-01
1.0 x 5.0 mm



20 cm/8"
20 cm/9"

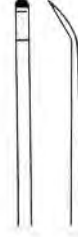

32-11482-01
32-11484-02
1.5 x 5.0 mm

20 cm/8"
20 cm/9"

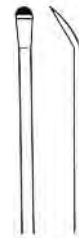

32-11482-03
32-11484-03
2.0 x 5.5 mm



20 cm/8"
23 cm/9"



32-11482-04
32-11484-04
2.5 x 6.0 mm



32-11482-05
32-11484-05
3.0 x 7.0 mm



20 cm/8"
23 cm/9"



32-11482-06
32-11484-06
3.5 x 7.0 mm



32-11482-07
32-11484-07
4.0 x 7.5 mm



20 cm/8"
23 cm/9"



32-11482-08
32-11484-08
5.0 x 8.0 mm

Working Length
12.5 cm/5"

Angaled up 32-11488-01
Curved down 32-11488-02
Curved right 32-11488-03
Curved left 32-11488-04

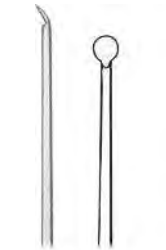

Curved upwards
32-11488-05



Angled up
32-11488-06
1.0 x 1.0 mm

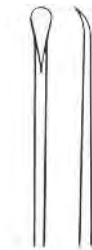

Angled up
32-11488-07
2.5 x 5 mm



Curved up
32-11488-08
1.0 x 4 mm

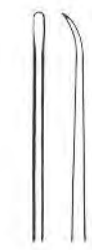

Curved up
32-11488-09
1.5 x 5 mm



Straight
32-11488-10
0.4 mm



Curved up
32-11488-11
2.0 x 6 mm

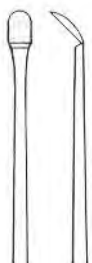







Angled Up 32-11488-12
3 x 5 mm
Angled To Right 32-11488-13
3 x 5 mm
Angled To Left 32-11488-14
3 x 5 mm

24 cm/9 1/2"

12.5 cm/5"



24 cm/9½"

			
	Blunt	Blunt	Semi-Sharp
Angled Up	32-11492-01	32-11492-02	32-11492-03
Curved Right	32-11494-01	32-11494-02	32-11494-03
Curved Left	32-11496-01	32-11496-02	32-11496-03
	90° 2 mm	90° 2.5 mm	90° 2 mm
			
	Blunt	Ball Pointed	Blunt
Angled Up	32-11492-04	32-11492-05	32-11492-06
Curved Right	32-11494-04	32-11494-05	32-11494-06
Curved Left	32-11496-04	32-11496-05	32-11496-06
	90° 3 mm	90° 3 mm	30° 3 mm

Working Length
12.5 cm/5"

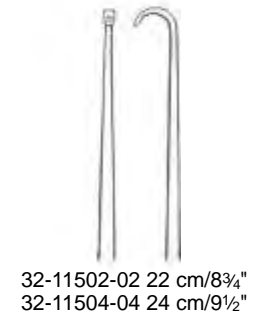
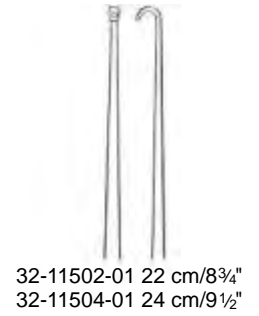

24 cm/9½"

22 cm/8¾"
24 cm/9½"



Hardy
24 cm/9½"

Sickle Dissectors



- Angled Up 32-11508-01
- Curved Down 32-11508-02
- Curved Right 32-11508-03
- Curved Left 32-11508-04



Implant Fork
32-11508-07

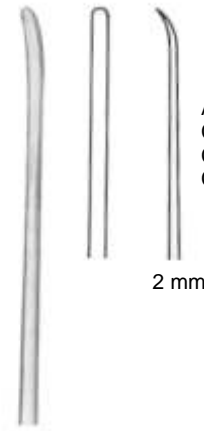

2 mm

- Angled Up 32-11508-08
- Curved Down 32-11508-09
- Curved Right 32-11508-10
- Curved Left 32-11508-11



Hardy-Fahlbusch
32-11508-05



Hardy-Fahlbusch
32-11508-06

4 mm



- Angled Up 32-11508-12
- Curved Down 32-11508-13



24 cm/9½"

Spatula Dissectors



Curved Up Flexible
32-11512-01
8 x 100 mm

Curved Down Flexible
32-11512-02
8 x 100 mm



Straight
32-11512-03
5 x 20 mm



32-11512-06
32-11512-07
2 mm

Dissectors Angled



Sharp Angled Up
32-11512-04
5 mm
Sharp Angled Down
32-11512-05

Raspatories



Curved Up
Curved Down

32-11512-08
32-11512-09
4 mm



24 cm/9½"

Right

Up
Down
Right
Left



32-11516-01
32-11518-01
32-11520-01
32-11522-01
Ø 2.5 mm
90°



32-11516-02
32-11518-02
32-11520-02
32-11522-02
Ø 4.0 mm
90°



32-11516-03
32-11518-03
32-11520-03
32-11522-03
Ø 5.0 mm
90°

Down

Up
Down
Right
Left



32-11516-04
32-11518-04
32-11520-04
32-11522-04
25 mm
45°



32-11516-05
32-11518-05
32-11520-05
32-11522-05
40 mm
45°



32-11516-06
32-11518-06
32-11520-06
32-11522-06
5 mm
45°



24 cm/9½"

Malleable



32-11526-01
90°
Ø 3 mm

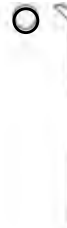

32-11526-02
45°
Ø 3 mm



32-11526-03
90°
Ø 3 mm



32-11526-04
45° Up
Ø 3 mm

With Stick



Stick 5 mm
32-11528-01
32-11530-01
32-11532-01
32-11534-01
90°
Ø 3 mm



Stick 5 mm
32-11528-02
32-11530-02
32-11532-02
32-11534-02
45°
Ø 3 mm



Stick 10 mm
32-11528-03
32-11530-03
32-11532-03
32-11534-03
45°
Ø 3 mm



32-11536-25
Ø 2.5 mm



32-11536-30
Ø 3.0 mm



32-11536-35
Ø 3.5 mm



32-11536-40
Ø 4.0 mm



Sharp
32-11538-01
24 cm/9½"



32-11538-02



32-11538-03



32-11538-04



32-11538-05



32-11538-06
2.5 mm



32-11538-07
3 mm



32-11538-08
3 mm



32-11538-09
5 mm



32-11538-10
8 mm



Curved Down
4.5 mm



Curved Down
4.5 mm

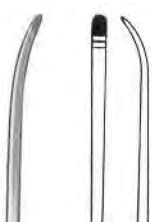

Caspar
Curved Down
32-11540-03
24 cm/9½"
2 mm



Caspar
32-11540-01
24 cm/9½"



Caspar
32-11540-02
24 cm/9½"



Caspar
32-11540-04
21.5 cm/8½"



Caspar
32-11540-05
21.5 cm/8½"



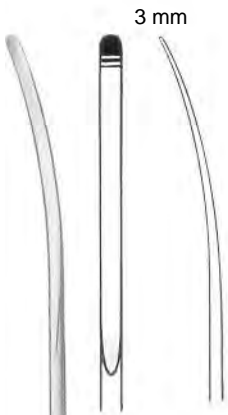

32-11542-01
19 cm/7½"



32-11542-02
21.5 cm/8½"

Curette



Ray
19 cm/7½"



Horizontal 45°
32-11546-01
Ø 4 mm



Vertical 45°
32-11546-02
Ø 4 mm

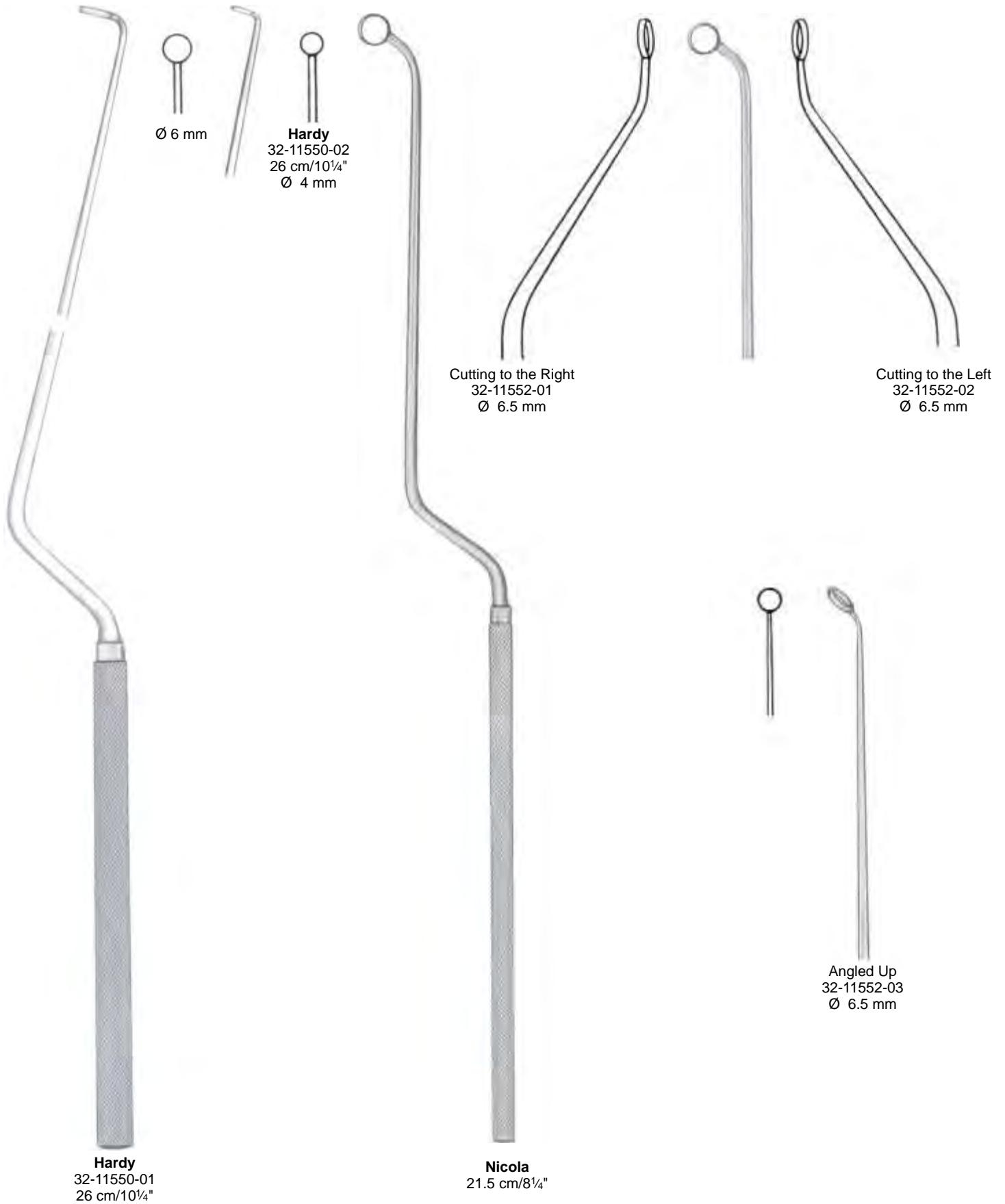



Nicola
32-11556-21
21.5 cm/8 1/4"



26 cm/10 1/4"

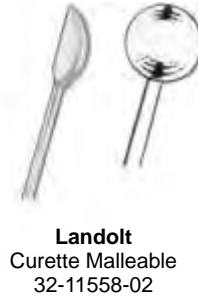

Landolt
Blunt Hook Malleable
32-11558-03

Landolt
Curette Malleable
32-11558-04

Landolt
32-11558-05

Landolt
32-11558-06

Enucleators Blunt Malleable



26 cm/10³/₄"



Landolt-Reulen
Dissector rigid
32-11562-01
2mm



Landolt-Reulen
Blunt Hook rigid
32-11562-02
1.7mm



Fahlbusch
Curette malleable
32-11562-03
2.5 mm Ø



Landolt-Reulen
Curette rigid
32-11562-04
2.5 mm Ø



Fahlbusch
Scoop malleable
32-11562-05



Landolt-Reulen
Raspatory rigid
32-11562-06
2.2 mm
3.2 mm



Cushing-Londot
32-11566-01 70 x 15 mm
32-11566-02 90 x 15 mm
32-11566-03 110 x 15 mm
Specula For Transsphenoidol

Mirrors



32-11570-06
6 mm



32-11570-10
12 mm



32-11570-08
8 mm



32-11570-012
10mm



Mirror handle
32-11570-00

Ø=Inside Dia



Troeltsch
For Babies

Fig. 1 33-11574-01 1.5 mm Ø
Fig. 2 33-11574-02 2.5 mm Ø
Fig. 3 33-11574-03 3.5 mm Ø

33-11574-30
Set of 3
Fig 1-3



Troeltsch
For Adults

Fig. 4 33-11574-04 4.0 mm Ø
Fig. 5 33-11574-05 5.0 mm Ø
Fig. 6 33-11574-06 6.0 mm Ø
Fig. 7 33-11574-07 7.0 mm Ø

33-11574-30 33-11574-40
Set of 3 Set of 4
Fig 4-6 Fig 4-7



Poltzer

Fig. 1 33-11578-01 2.0 mm Ø
Fig. 2 33-11578-02 3.0 mm Ø
Fig. 3 33-11578-03 4.0 mm Ø

33-12278-30
Set of 3
Fig 1-3



Erhard
For Adults

Fig. 1 33-11582-01 3.0 mm Ø
Fig. 2 33-11582-02 4.0 mm Ø
Fig. 3 33-11582-03 5.0 mm Ø
Fig. 4 33-11582-04 6.0 mm Ø

33-11582-30 33-11582-40
Set of 3 Set of 4
Fig.1-3 Fig.1-4



Hartmann
For Babies

Fig. 1 33-11586-01 2.0 mm Ø



Hartmann
For Children

Fig. 2 33-11586-02 3.0 mm Ø
Fig. 3 33-11586-03 4.0 mm Ø
Fig. 4 33-11586-04 5.5 mm Ø

33-11586-30
Set of 3
Fig.2-4



Hartmann
For Adults

Fig. 3 33-11590-03 4.0 mm Ø
Fig. 4 33-11590-04 5.5 mm Ø
Fig. 5 33-11590-05 6.5 mm Ø
Fig. 6 33-11590-06 7.5 mm Ø

33-11590-30 33-11590-40
Set of 3 Set of 4
Fig.4-6 Fig.3-6



Toynbee
For Adults

Fig. 1 33-11594-01 4.5 mm Ø
Fig. 2 33-11594-02 5.5 mm Ø
Fig. 3 33-11594-03 6.5 mm Ø
Fig. 4 33-11594-04 7.5 mm Ø

33-11594-30 33-11594-40
Set of 3 Set of 4
Fig.2-4 Fig.1-4

Alu Black



33-11598-60
Set of 6
Fig. 1-6

- Ø=Inside Dia
- Fig. 1 33-11598-01
4.5 x 5.5 mm Ø
 - Fig. 2 33-11598-02
5.5 x 6.5 mm Ø
 - Fig. 3 33-11598-03
6.5 x 7.5 mm Ø
 - Fig. 4 33-11598-04
7.5 x 8.5 mm Ø
 - Fig. 5 33-11598-05
8.5 x 9.5 mm Ø
 - Fig. 6 33-11598-06
9.5 x 10.5 mm Ø



Gruber

33-11602-30 Set of 3 Fig. 2-4
33-11602-40 Set of 4 Fig. 1-4
33-11604-40 Set of 3 Fig. 2-4
33-11604-40 Set of 4 Fig. 1-4

- Fig. 1 33-11602-01
2.8 x 3.8 mm Ø
- Fig. 2 33-11602-02
3.8 x 4.8 mm Ø
- Fig. 3 33-11602-03
5.0 x 6.2 mm Ø
- Fig. 4 33-11602-04
6.0 x 7.2 mm Ø
- Fig. 1 33-11604-01
4.5 mm Ø
- Fig. 2 33-11604-02
5.0 mm Ø
- Fig. 3 33-11604-03
5.5 mm Ø
- Fig. 4 33-11604-04
6.0 mm Ø

Black



Hartmann
33-11608-40
Set of 4
Fig. 1-4

- Fig. 1 33-11608-01
3.0 mm Ø
- Fig. 2 33-11608-02
4.0 mm Ø
- Fig. 3 33-11608-03
5.0 mm Ø
- Fig. 4 33-11608-04
7.0 mm Ø

Black



Hartmann
33-11608-20
Set of 2
Fig. 5-6

- Fig. 5 33-11608-05
9.0 mm Ø
- Fig. 6 33-11608-06
11.0 mm Ø



Boucheron
33-11612-40
Set of 4
Fig. 3-6

- 33-11612-03 3.5 mm Ø
- 33-11612-04 4.5 mm Ø
- 33-11612-05 5.5 mm Ø
- 33-11612-06 6.5 mm Ø



33-11618-01



33-11618-02



33-11618-03

- Fig. 1 33-11618-01 4.2 x 3.8 mm
 - Fig. 2 33-11618-02 5.5 x 3.8 mm
 - Fig. 3 33-11618-03 6.5 x 3.8 mm
- 33-11618-30
Set of 3
Fig. 1-3



33-11620-01



33-11620-02



33-11620-03

Fig. 1 33-11620-01 4.2 mm
Fig. 2 33-11620-02 5.5 mm
Fig. 3 33-11620-03 6.5 mm
33-11620-30
Set of 3
Fig.1-3



Richnau-Holmgren

- 33-11628-02 2.0 mm Ø
- 33-11628-04 4.0 mm Ø
- 33-11628-06 6.0 mm Ø

Metal supports for specula



For 12 Specula
33-11624-00



Siegle



6.5 mm



7 mm



8 mm

Otoscope with 3 ear specula and rubber tube with bulb
33-11632-00

Tuning Forks



Hartmann



Lucae



French
Hartmann



Lucae
C 128



Hartmann
C 128

C ₂	16			33-11644-16
C ₂	32			33-11644-32
C	64			33-11645-01
C	128	33-11636-00	33-11640-00	33-11645-02
C ₁	256	33-11636-01	33-11640-01	33-11645-03
C ₂	512	33-11636-02	33-11640-02	
C ₃	1024	33-11636-03	33-11640-03	
C ₄	2048	33-11636-04	33-11640-04	
C ₅	4096	33-11636-05	33-11640-05	

Variable up to h (Engl. B)

33-11648-00

33-11652-00



Rydel-Seiffer
33-11656-00
C 64/C 128

With Clamps = C 64
Without Clamps = C 128



Tuning Fork for neuro-
logical examination, with
percussion hammer, pin
wheel, brush and needle

33-11660-00



33-11664-01
C 64



33-11664-02
C 128



33-11664-03
C 256



33-11664-04
C 512



33-11664-05
C 1024



33-11664-06
C 2048



33-11664-07
C 4096



Hartmann

- 33-11668-20
2.0 mm Ø
- 33-11668-25
2.5 mm Ø
- 33-11668-30
3.0 mm Ø
- 33-11668-40
4.0 mm Ø
- 33-11668-50
5.0 mm Ø



Itard

- 33-11672-30
3 mm Ø
- 33-11672-35
3.5 mm Ø
- 33-11672-40
4 mm Ø
- 33-11672-45
4.5 mm Ø
- 33-11672-50
5 mm Ø

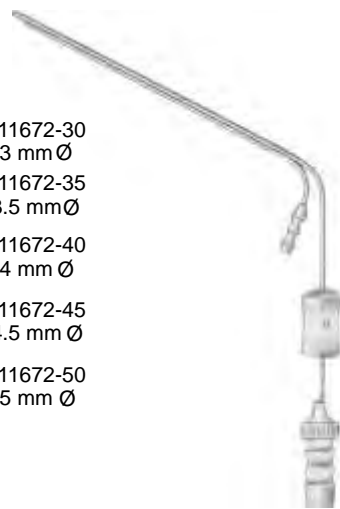

House

- 33-11676-09 0.9 mm Ø
- 33-11676-12 1.2 mm Ø
- 33-11676-15 1.5 mm Ø



Baron (Schuknecht)

- 33-11680-01 1.0 x 75 mm Ø
- 33-11680-02 1.5 x 75 mm Ø
- 33-11680-03 2.0 x 75 mm Ø



Krause
33-11684-16
16 cm/6¼"



Krause-Voss
33-11688-16
16 cm/6¼"



Lange-Wilde
33-11692-16
16 cm/6¼"



Package of 1 dozen each

	mm Ø
33-11700-02	0.2
33-11700-03	0.3

Ear Dressing Forceps



**Troeltsch
(Wilde)**



Troeltsch



Lucae



Lucae



Jansen

Cm	In	Troeltsch (Wilde)	Troeltsch	Lucae	Lucae	Jansen
11.0	4¼"	33-11704-11				
12.0	4¾"	33-11704-12	33-11706-12		33-11712-14	
14.0	5½"	33-11704-14		33-11710-14		
15.0	6"	33-11704-15				
16.0	6¼"					33-11716-16
18.0	7"					33-11716-18
20.0	8"					33-11716-20

Otology Instruments Ear Polypus Forceps and Foreign Body Levers



Okonogto
33-11720-16
16 cm/6¼"



Littauer
33-11724-12
12 cm/4¾"



Hartmann
33-11726-12
12 cm/4¾"

Fine Pattern



Hartmann
33-11728-14
14 cm/5½"

Standard Pattern

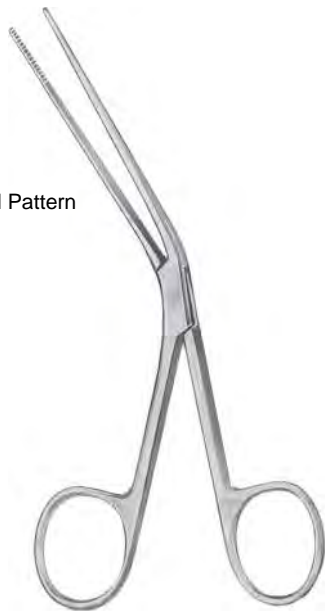

Tilley
33-11732-14
33-11732-16
14 cm/5½"



Buck
33-11736-09
9 cm/3½"



Quire
33-11740-08
8 cm/3¼"



Hartmann-Noyes
33-11744-09
8.5 cm/3¼"



1 : 2

Hartmann-Noyes
33-11746-09
8.5 cm/3¼"



Hartmann
33-11750-09 8.5 cm/3¼"
33-11750-14 14 cm/5½"
33-11750-16 16 cm/6¼"



1 : 2

Hartmann
33-11752-09 8.5 cm/3¼"
33-11752-14 14.0 cm/5½"



Hartmann
33-11756-20 8.5 cm/3¼" ○ 2.0 mm
33-11756-25 8.5 cm/3¼" ○ 2.5 mm
33-11756-30 8.5 cm/3¼" ○ 3.0 mm



Hartmann-Citelli
33-11760-02 ○ 2 mm 8.5 cm/3¼"
33-11760-03 ○ 3 mm 8.5 cm/3¼"



Strumpel
33-11762-09
8.5 cm/3¼"



Hartamm-Weingartner
33-11766-09
8.5 cm/3¼"



Hartamm
33-11770-09
8.5 cm/3¼"













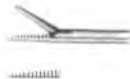

Hartamm-Wullstein
33-11774-06 8.5 cm/3¼" 08 x 6 mm
33-11774-08 8.5 cm/3¼" 1.8 x 8 mm



Hartamm-Wullstein
33-11778-01 ○ 1 mm 8.5 cm/3¼"
33-11778-02 ○ 2 mm 8.5 cm/3¼"



Length of Shaft 8 cm

	Micro Forceps	Mini	Cup-Shaped Forceps
	1.6 x 7.0 mm  33-11782-01	0.7 x 3.5 mm  33-11782-08	0.9 x 1.1 mm  33-11782-11
	 33-11782-02 0.8 x 4.0 mm		
Smooth Jaw	 33-11782-03 0.8 x 6.0 mm		
Curved Left	 33-11782-04 0.8 x 6.0 mm		 33-11782-12 0.9 x 1.1 mm
Curved Right	 33-11782-05 0.8 x 4.0 mm		 33-11782-13 0.9 x 1.1 mm
Angled Up	 33-11782-06 0.8 x 4.0 mm		 33-11782-14 0.9 x 1.1 mm
Angled Down	 33-11782-07 0.8 x 4.0 mm		 33-11782-15 0.9 x 1.1 mm

Micro Forceps



Greven
33-11782-16
0.8 x 5.0 mm



Cos
33-11782-18
0.8 x 3.0 mm

Left Angled



Juers
33-11782-19
0.8 x 6.0 mm



Hough
33-11782-21
0.8 x 3.0 mm

Right Angled



Juers
33-11782-20
0.8 x 6.0 mm



Hough
33-11782-22
0.8 x 3.0 mm



Fuller
33-11782-23
0.8 x 6.0 mm



Tabb
33-11782-24

Upward Cutting



Dieter
33-11782-30

Downward Cutting



Dieter
33-11782-31

Cutting to the Right



Dieter
33-11782-32

Cutting to the left



Dieter
33-11782-33

Micro Scissors



Bellucci
33-11786-01
4.0 mm



Bellucci
33-11786-02
5.5 mm

Angled Up



Bellucci
33-11786-03
5.5 mm

Curved Left



Bellucci
33-11786-04
5.5 mm

Curved Right



Bellucci
33-11786-05
5.5 mm

Curved Left



Shea
33-11786-06
7.0 mm

Curved Right



Shea
33-11786-07
7.0 mm

Shea
33-11786-08
7.0 mm

Otology Instruments Micro Ear Polypus Dressing Forceps



Length of Shaft 8 cm

Micro Forceps

0.5 mm

Smooth Jaw

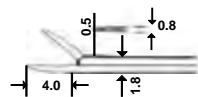

Straight

33-11790-01

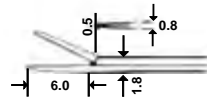

33-11790-02

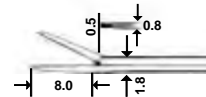

33-11790-03

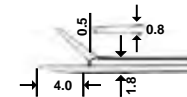

33-11790-04

Curved Right
Curved Left
Angled Up
Angled Down

33-11794-01
33-11794-02
33-11794-03
33-11794-04

Micro Forceps

0.3 mm

Smooth Jaw

Straight

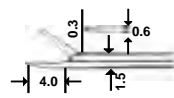

33-11800-01

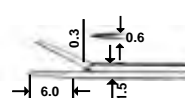

33-11800-02

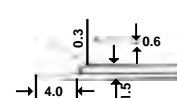

33-11800-03

Length of Shaft 8 cm

Cup-Shaped Forceps



Micro Scissors



Bellucci
0.8 mm

1.5 x 0.8 mm

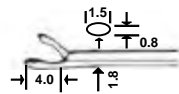

- Straight 33-11804-01
- Curved Right 33-11804-02
- Curved Left 33-11804-03
- Angled Up 33-11804-04
- Angled Down 33-11804-05

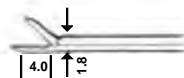

- 33-11806-01
- 33-11806-02
- 33-11806-03
- 33-11806-04
- 33-11806-05

1.0 x 0.5 mm

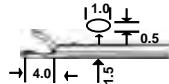

- Straight 33-11804-06

Length of Shaft 8 cm

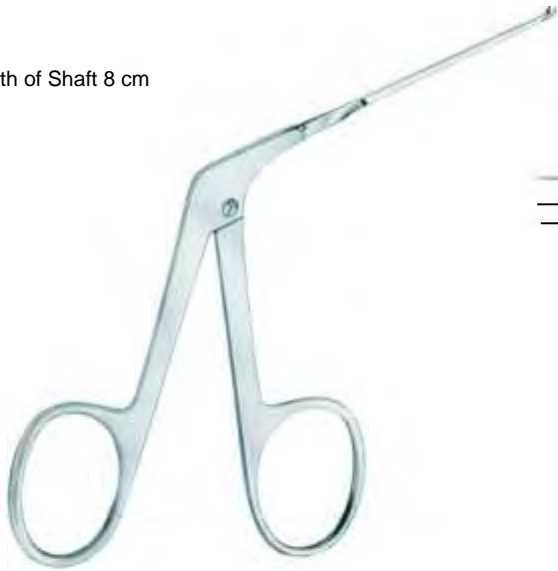

Crura Forceps



Open to Right

Fisch
33-11810-01



Open to Left

Fisch
33-11810-02

Length of Shaft 8 cm



Wire Closure Forceps



Mc Gee
33-11814-01



Mc Gee/Fisch
33-11814-02



33-11818-01



33-11818-02

Micro Scissors



33-11820-01



33-11820-02

Micro Forceps



33-11822-01



33-11822-02

Cup-Shaped Forceps

Messer

Knives



Schuknecht
33-11826-01



Schuknecht
33-11826-02



Schuknecht
33-11828-01



Wullstein
33-11830-01



Tabb
33-11832-01



Plester
33-11834-01



Plester
33-11834-02



33-11834-03



Rosen



33-11838-10
1.0 mm



33-11838-14
1.4 mm



33-11838-16
1.6 mm



33-11838-20
2.0 mm



33-11838-26
2.6 mm



33-11838-28
2.8 mm



33-11838-30
3.0 mm

Needles And Hooks



Barbara
33-11842-01



33-11842-02



33-11842-03



Rosen
33-11842-04



Barbara



25°
33-11844-03 0.3 mm
33-11844-06 0.6 mm
33-11844-10 1.0 mm

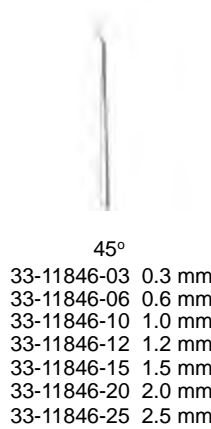

45°
33-11846-03 0.3 mm
33-11846-06 0.6 mm
33-11846-10 1.0 mm
33-11846-12 1.2 mm
33-11846-15 1.5 mm
33-11846-20 2.0 mm
33-11846-25 2.5 mm

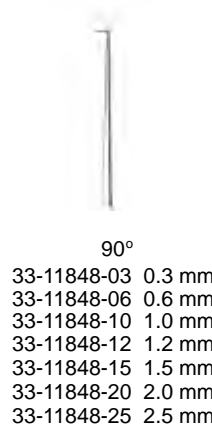

90°
33-11848-03 0.3 mm
33-11848-06 0.6 mm
33-11848-10 1.0 mm
33-11848-12 1.2 mm
33-11848-15 1.5 mm
33-11848-20 2.0 mm
33-11848-25 2.5 mm



33-11850-05 0.5 mm
33-11850-10 1.0 mm

Needles And Hooks



90°

33-11852-03 0.3 mm
33-11852-06 0.6 mm
33-11852-10 1.0 mm

90°

33-11854-03 0.3 mm
33-11854-06 0.6 mm
33-11854-10 1.0 mm

90°

McGee
33-11856-05 0.5 mm
33-11856-10 1.0 mm

McGee

33-11858-05 0.5 mm
33-11858-10 1.0 mm



25°

33-11862-03 0.3 mm
33-11862-06 0.6 mm
33-11862-10 1.0 mm

25°

33-11864-03 0.3 mm
33-11864-06 0.6 mm
33-11864-10 1.0 mm

45°

33-11868-03 0.3 mm
33-11868-06 0.6 mm
33-11868-10 1.0 mm

45°

33-11870-03 0.3 mm
33-11870-06 0.6 mm
33-11870-10 1.0 mm

Barbara
33-11860-01

Rosen
33-11860-02

Dissectors, Measuring Road, Elevators, Curettes and Mobilizer



Fisch



33-11874-01



33-11874-02



33-11874-03



33-11874-04



Rosen

33-11878-15 33-11878-25
1.5 mm 2.5 mm



Rosen



33-11880-01



33-11880-02



33-11880-03



33-11880-04



33-11880-05



33-11880-06



House



33-11882-01
3.5 mm



33-11882-02
4.0 mm



33-11882-03
4.5 mm



33-11882-04
5.0 mm



Buckingham



33-11886-01



33-11886-02



33-11886-03



House

33-11890-10 1.0/1.2 mm
33-11890-15 1.5/1.8 mm



House

33-11892-10 1.0/1.2 mm
33-11892-15 1.5/1.8 mm



Shea

33-11896-15 1.5 mm



33-11900-01 33-11900-02 33-11900-03



Zollner

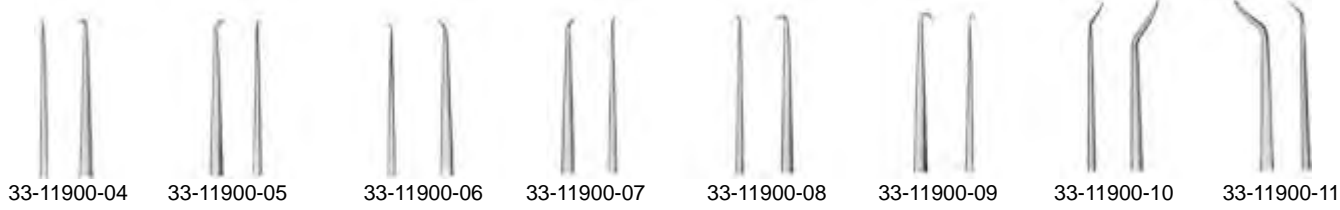

33-11900-04 33-11900-05 33-11900-06 33-11900-07 33-11900-08 33-11900-09 33-11900-10 33-11900-11



33-11900-12 33-11900-13 33-11900-14 33-11900-15 33-11900-16 33-11900-17

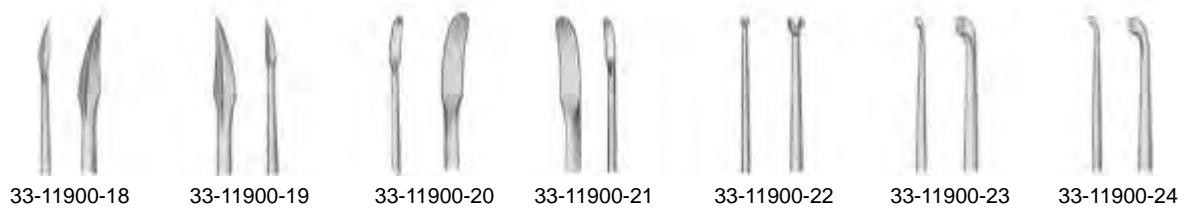

33-11900-18 33-11900-19 33-11900-20 33-11900-21 33-11900-22 33-11900-23 33-11900-24



Width of Bite
Citelli
33-11904-20 2.0 mm
33-11904-30 3.0 mm



Width of Bite
Citelli-Beyer
33-11906-15 1.5 mm
33-11906-20 2.0 mm







Width of Bite
4.0 mm
6.0 mm
Brunings
33-11910-40
33-11910-60

33-11912-30 3.0 mm
33-11912-40 4.0 mm
33-11912-50 5.0 mm
33-11912-60 6.0 mm



Kerrison
20 cm/8"



		Fig. 000	00	0	1	2	3	4	5
Blunt		33-11914-30	33-11914-20	33-11914-10	33-11914-01	33-11914-02	33-11914-03	33-11914-04	33-11914-05
Sharp		33-11915-30	33-11915-20	33-11915-10	33-11915-01	33-11915-02	33-11915-03	33-11915-04	33-11915-05
Blunt		33-11916-30	33-11916-20	33-11916-10	33-11916-01	33-11916-02	33-11916-03	33-11916-04	33-11916-05
Sharp		33-11917-30	33-11917-20	33-11917-10	33-11917-01	33-11917-02	33-11917-03	33-11917-04	33-11917-05



Langenbeck
33-11920-13
13 cm/5 1/8"



Shapleigh
13 cm/5 1/8"

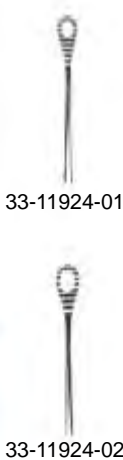

Jansen
33-11928-15
15 cm/6"



Barth
33-11932-18
18 cm/7"



Billeau
16.5 cm/6 1/2"



Snellen
16 cm/6 1/4"

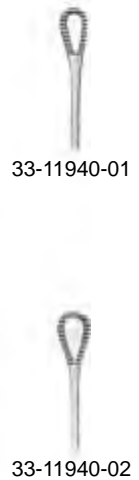

Otology Instruments Ear Foreign Body Instruments, Hooks and Knives



Gross
33-11944-12
12 cm/4¾"



Zaufal
33-11948-16
16 cm/6¼"



Hartmann
33-11952-16
16 cm/6¼"



Lucae
14 cm/5½"

33-11956-01

33-11956-02

33-11956-03



Wagner
14 cm/5½"

33-11960-01

33-11960-02

33-11960-03

33-11960-04

33-11960-05

33-11960-06



Day
16 cm/6¼"

33-11964-01

33-11964-02



Muck
33-11968-13
13.5 cm/5⅝"



Politzer
33-11972-16
16 cm/6¼"



Fig. Straight Sexton
1 33-11976-01
2 33-11976-02
3 33-11976-03



Curved Sexton
33-11980-01
33-11980-02
33-11980-03



Gerzog-Sexton
33-11984-17
17 cm/6½"

Messer



Politzer
33-11988-17
17 cm/6¾"



Lempert
33-11992-15
15 cm/6 "



Lempert
15 cm/6"

33-11996-01

33-11996-02



Lempert
33-12000-01
15 cm/6"

Knives



Lempert
33-12000-02
15 cm/6"

Ear Operating Set

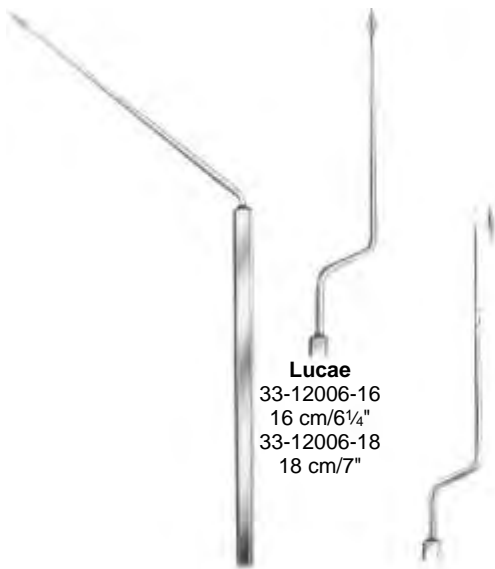

Lucae
33-12006-16
16 cm/6¼"
33-12006-18
18 cm/7"

Politzer
33-12004-16
16.5 cm/6½"

Lucae
33-12008-18
18 cm/7 "



Politzer
33-12012-17
17 cm/6¾"



Sprague
33-12014-19
19 cm/7½"



33-12018-10



33-12018-20



33-12018-30

Ear Syringe, Complete With 2 Cannulas and 1 Protecting Disk

33-12018-02	50 ml
33-12018-03	75 ml
33-12018-04	100 ml
33-12018-06	150 ml
33-12018-08	200 ml



Fraenkel
34-12022-01 Fig. 1
34-12022-02 Fig. 2
34-12022-03 Fig. 3



34-12026-01
34-12026-02
34-12026-03
13 cm/5"



Fig. 1
34-12026-01
34-12028-01

Fig. 2
34-12026-02
34-12028-02

Fig. 3
34-12026-03
34-12028-03



34-12028-01
34-12028-02
34-12028-03
13 cm/5"



Hartmann
15 cm/6"

34-12030-01

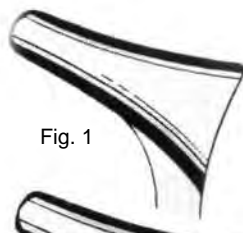

Fig. 1

34-12032-01

34-12030-02



Fig. 2

34-12032-02

34-12030-03

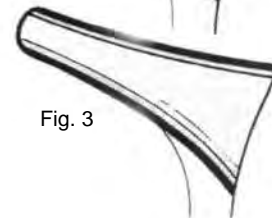

Fig. 3

34-12032-03



Hartmann
15 cm/6"



34-12036-01

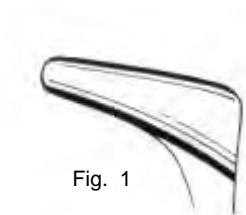

Fig. 1



Fig. 2

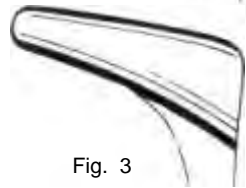

Fig. 3

34-12036-02

34-12036-03

Hartmann-Halle
15 cm/6"



34-12038-01

34-12038-02

34-12038-03

Hartmann-Halle
15 cm/6"



34-12042-01

34-12042-02

Tieck
13.5 cm/5 1/4"



34-12044-01

34-12044-02



Tieck
13.5 cm/5 1/4"



Beckmann
15 cm/6"



Fig. 1
34-12048-01

Fig. 2
34-12048-02

Fig. 3
34-12048-03



34-12052-01

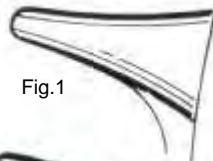

Fig.1

34-12054-01



34-12052-02

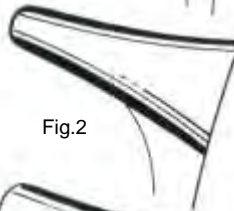

Fig.2

34-12054-02

34-12052-03

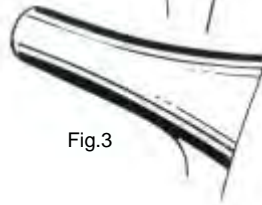

Fig.3

34-12054-03

Mod.Wien

Wien



Killian



Fig.1
34-12058-01
35 mm



Fig.2
34-12058-02
50 mm



Fig.3
34-12058-03
75 mm



Fig.4
34-12058-04
90 mm



Cottle
34-12062-01
34-12062-02
34-12062-03
34-12062-04
15 cm/6"

Cottle
34-12064-01
34-12064-02
34-12064-03
34-12064-04
15 cm/6"



Fig 1
34-12062-01
34-12064-01
35 mm

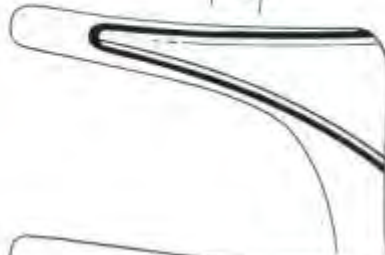

Fig 2
34-12062-02
34-12064-02
50 mm



Fig 3
34-12062-03
34-12064-03
75 mm



Fig 4
34-12062-04
34-12064-04
90 mm



34-12068-30 Fig. 1- 3
34-12068-40 Fig. 1- 4
34-12068-70 Fig. 1- 7



34-12068-01



34-12068-02



34-12068-03

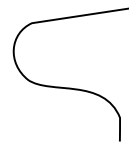

34-12068-04

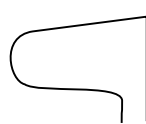

34-12068-05

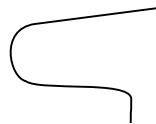

34-12068-06

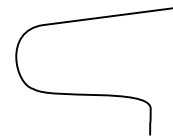

34-12068-07



Krause
34-12074-26
26 cm/10¼"



Krause-Voss
34-12076-26
26 cm/10¼"



Lange-Wilde
34-12078-24
24 cm/9½"

Package Of 1 Dozen Each
34-12080-10
0.3 mm



Cm	In	Troeltsch (Wilde)
15.0	6	34-12084-15
18.0	7	34-12084-18
20.0	8	34-12088-20



Cm	In	Gruenwald (Jansen)
15.0	6	34-12088-15
18.0	7	34-12088-18
20.0	8	34-12088-20



Westmacott (West)
34-12092-20
20 cm/8"

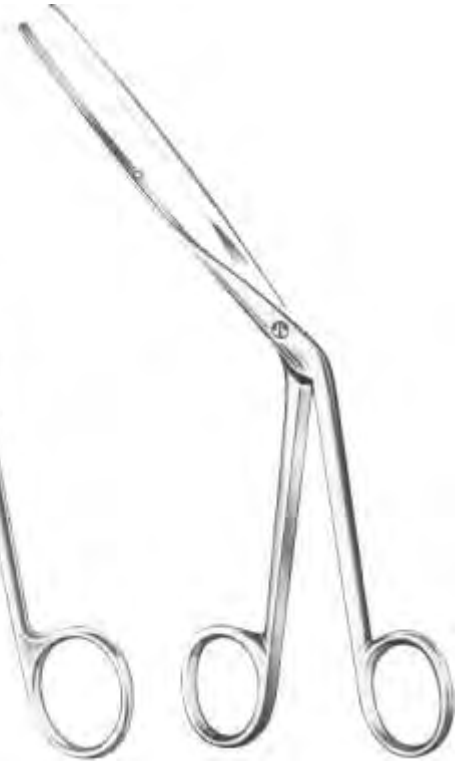

Lubet-Barbon
34-12096-20
20 cm/8"

Rhinology Instruments Nasal polypus and Septum Compression Forceps



Hartmann
34-13000-16
16 cm/6¼"

Hartmann
34-13002-20
20 cm/8"

Heymann
34-13006-18
18 cm/7"

Craig
34-13010-18
18 cm/7"

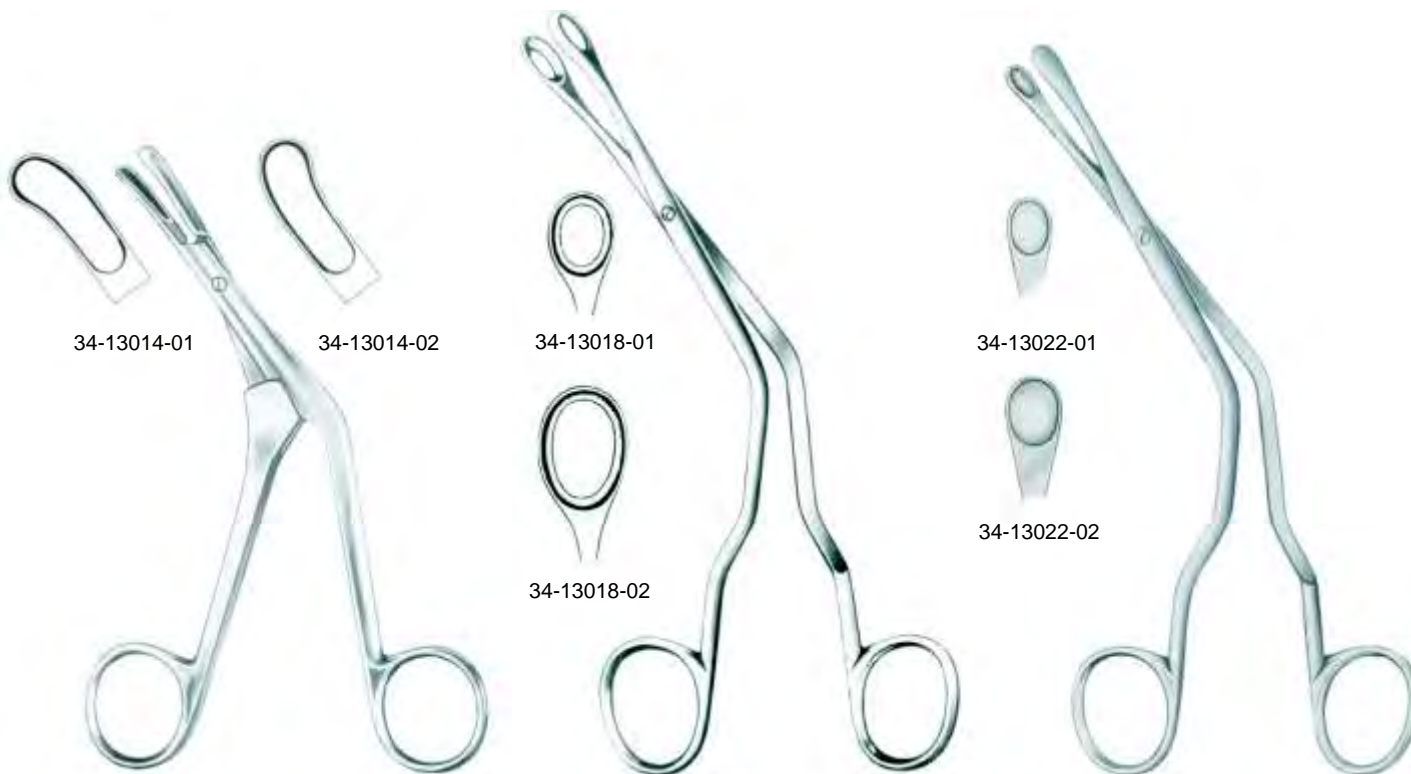

34-13014-01

34-13014-02

34-13018-01

34-13022-01

34-13018-02

34-13022-02

Craig Domnick
18 cm/7"

Luc
20 cm/8"

Luc
20 cm/8"



Bruenings
19 cm/7½"

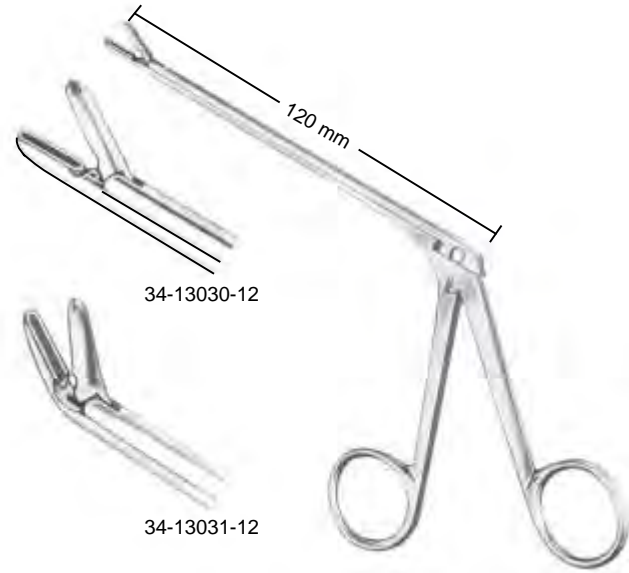

Takahashi
19 cm/7½"



Watson-Williams
19 cm/7½"

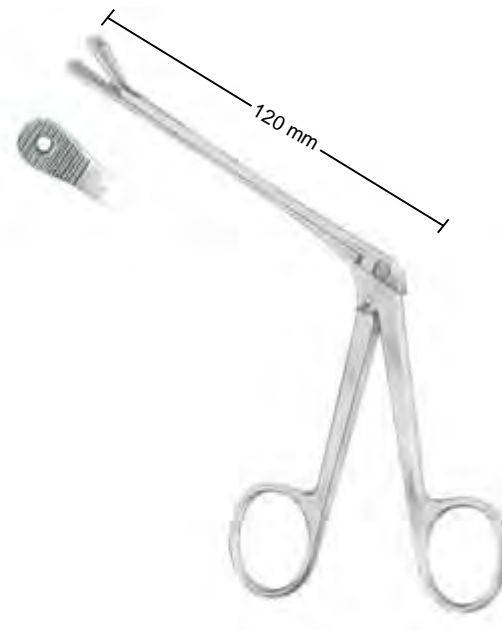

Ferris-Smith
34-13038-12
19 cm/7½"

Rhinology Instruments Nasal Cutting Forceps

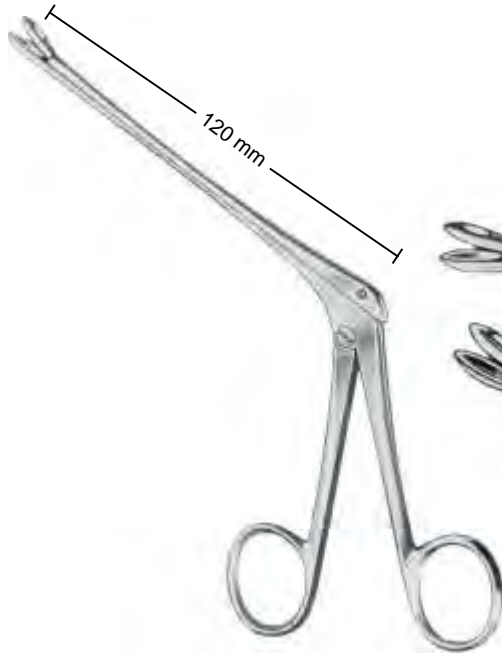

Weil-Blakesley

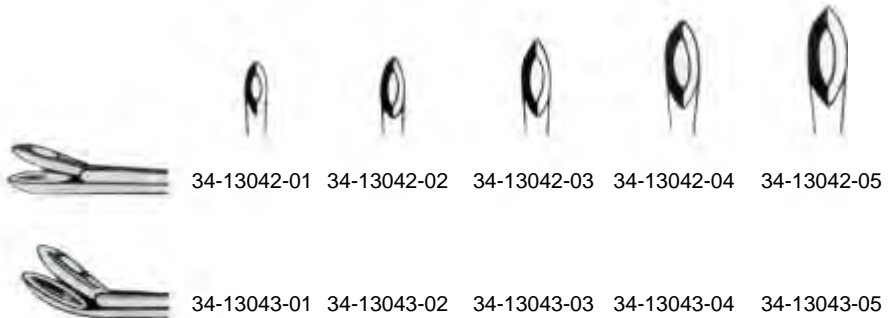

Struycken

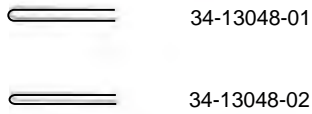

34-13048-01
34-13048-02



Hajek

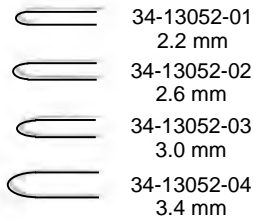

34-13052-01
2.2 mm
34-13052-02
2.6 mm
34-13052-03
3.0 mm
34-13052-04
3.4 mm



Myles

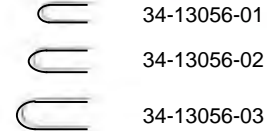

34-13056-01
34-13056-02
34-13056-03



Grunwald

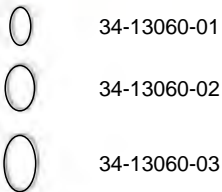

34-13060-01
34-13060-02
34-13060-03



Grunwald
34-13062-01



Hartmann

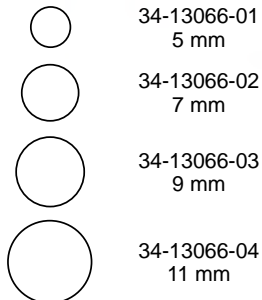

34-13066-01
5 mm
34-13066-02
7 mm
34-13066-03
9 mm
34-13066-04
11 mm



Schmeden

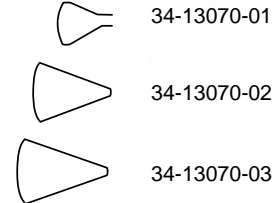

34-13070-01
34-13070-02
34-13070-03



Middleton-Jansen
34-13074-19
19 cm/7½"



Middleton-Jansen
34-13076-19
19 cm/7½"



Kazanjan
34-13080-18
18 cm/7"



Caplan
34-13084-20
20 cm/8"

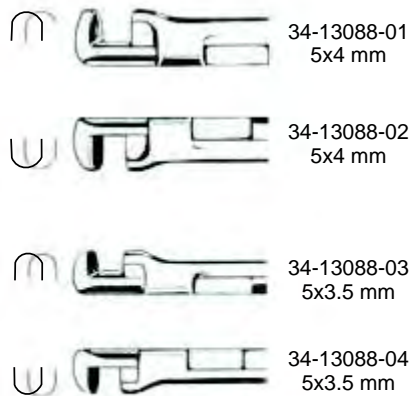

34-13088-01
5x4 mm

34-13088-02
5x4 mm

34-13088-03
5x3.5 mm

34-13088-04
5x3.5 mm

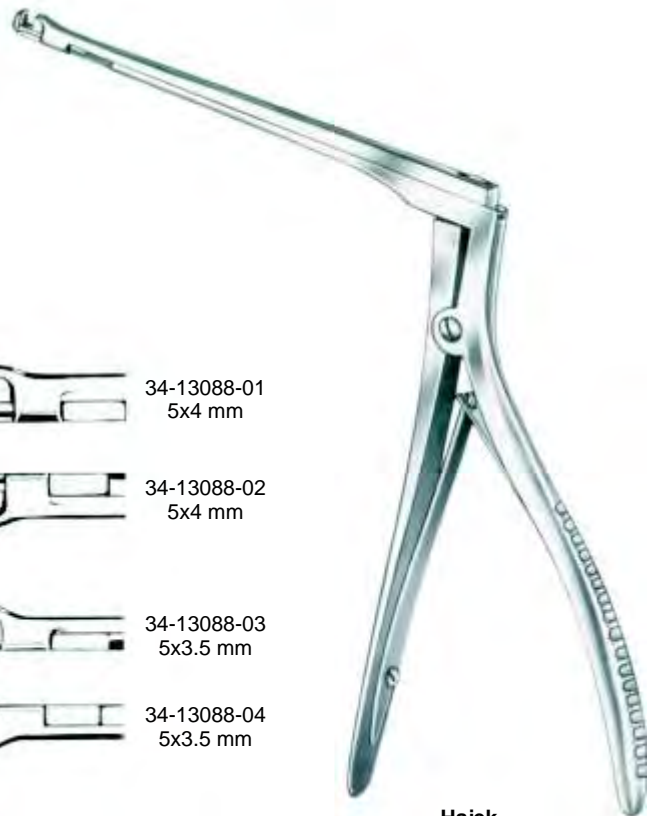

Hajek
(Hajek-Kofler)
Shaft
14 cm/5½"

Rhinology Instruments Antrum Punch Forceps



Ferris-Smith-Kerrison



Ferris-Smith-Kerrison

	Width of Bite	Length of Shaft			Width of Bite	Length of Shaft		
		15 cm/6"	20 cm/8"	18 cm/7"		15 cm/6"	20 cm/8"	18 cm/7"
Cutting Upward	3 mm	34-13092-03	34-13098-03	34-13104-03	1 mm	34-13108-03	34-13114-03	34-13120-01
	4 mm	34-13092-05	34-13098-05	34-13104-05	2 mm			34-13120-02
	5 mm				3 mm			34-13120-03
	5 mm				4 mm			34-13120-04
Cutting Upward 40°	3 mm	34-13094-03	34-13100-03		3 mm	34-13110-03	34-13116-03	34-13122-01
	4 mm	34-13094-05	34-13100-05		4 mm			34-13122-02
	5 mm			5 mm	34-13122-03			
	5 mm			5 mm	34-13122-04			
Cutting Downward	3 mm	34-13096-03	34-13102-03	34-13106-03	1 mm	34-13112-03	34-13118-03	34-13124-01
	4 mm	34-13096-05	34-13102-05	34-13106-05	2 mm			34-13124-02
	5 mm				3 mm			34-13124-03
	5 mm				4 mm			34-13124-04
	5 mm			5 mm	34-13124-05			



360° Turnable

Hajek-Kofler
34-13128-16
16 cm/6½"

- 34-13132-03
3 mm
- 34-13132-04
4 mm
- 34-13132-05
5 mm
- 34-13132-06
6 mm



Kerrison
20 cm/8"



Jurasz
22 cm/8¾"



34-13136-01



34-13136-02



34-13136-03

Rhinoplastic and Nasal Knives



Joseph
Pointed

← Straight
34-13140-01



Curved
34-13141-01



Joseph
Blunt

← Straight
34-13144-01



Curved
34-13145-01



Converse
34-13149-15
15 cm/6"



Joseph
34-13152-14
14 cm/5½"



Cottle
34-13156-15
15 cm/6"



Cottle
34-13158-14
14 cm/5½"



Freer
34-13162-16
16 cm/6¼"



Joseph
34-13166-16
16.5 cm/6½"



Maltz
34-13170-16
16.5 cm/6½"



Freer
34-13174-19
19 cm/7½"

Septum Knives



Ballenger
20cm/8"



34-13178-03 3 mm 34-13179-03
34-13178-04 4 mm 34-13179-04
34-13178-05 5 mm 34-13179-05



Ballenger
20cm/8"



Bruenings
34-13182-16



34-13186-04 4 mm
34-13186-05 5 mm

Mc Kenty
15 cm/6"



Halle
34-13190-16
16.5 cm/6½"



Joseph
34-13194-16
16.5 cm/6½"



Cottle
34-13198-19
19.5 cm/7½"



Blunt

Freer
34-13202-19
19 cm/7½"



Sharp

Freer
34-13203-19
19 cm/7½"



Freer
34-13206-18
18 cm/7"



Freer-Yasargil
34-13208-18
18.5 cm/7¼"



Howarth
34-13212-21
21.5 cm/8½"



Mc Kenty
34-13216-22
22 cm/8¾"



Killian
34-13220-18
18.5 cm/7¼"



Cottle
34-13224-23
23 cm/9"



Killian
34-13228-18
18.5 cm/7¼"



Pierce
34-13232-21
21 cm/8¼"



Pennington
34-13236-21
21 cm/8¼"

Raspatories



34-13240-18
18 cm/7"



**Joseph (Cottle)
Masing**
34-13244-22
22 cm/8¾"



Masing
34-13248-20
20.5 cm/8⅜"



Joseph
34-13252-16
16cm/6¼"

Periost-Elevators

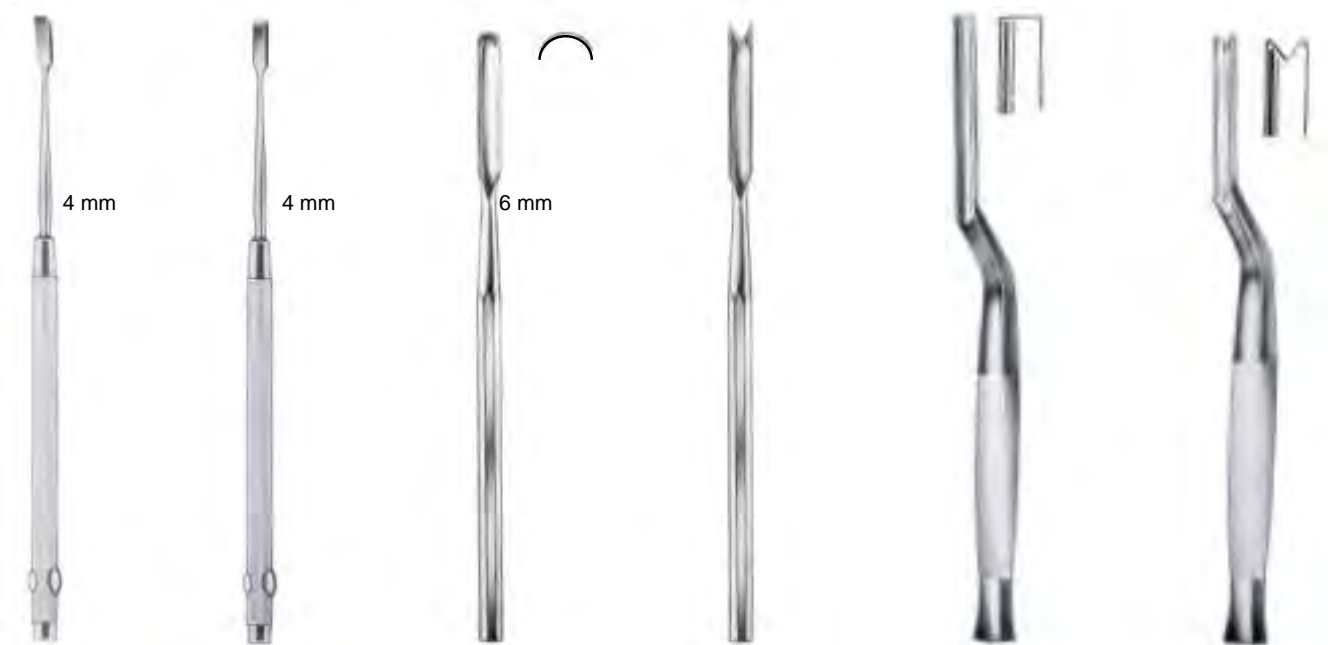

Freer
34-13256-16
16 cm/6 1/4"

Freer
34-13260-16
16 cm/6 1/4"

Freer
34-13264-15
15 cm/6"

Ballenger
34-13268-04 4 mm
34-13268-06 6 mm
34-13268-08 8 mm
16 cm/6 1/4"

Killian
34-13272-16
16 cm/6 1/4"

Killian-Claus
34-13276-16
16 cm/6 1/4"

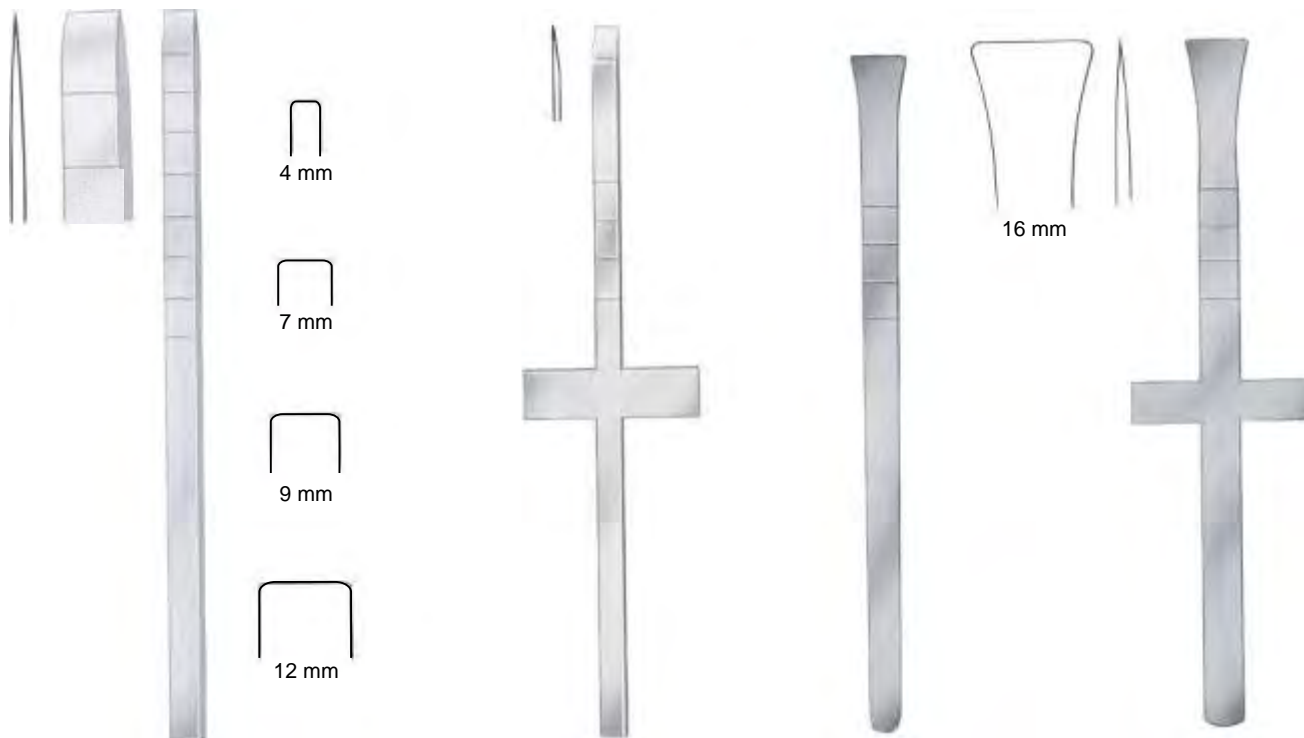

Cottle
34-13280-04 4 mm
34-13280-07 7 mm
34-13280-09 9 mm
34-13280-12 12 mm
18 cm/7"

Cottle
34-13284-04 4 mm
34-13284-07 7 mm
34-13284-09 9 mm
34-13284-12 12 mm
18 cm/7"

Cottle
34-13288-18
18 cm/7"

Cottle
34-13290-18
18 cm/7"

Rhinology Instruments Nasal Septum Chisels



34-13294-08
16 cm/6¼"
8 mm



Cottle
34-13298-04 4 mm
34-13298-07 7 mm
34-13298-09 9 mm
34-13298-12 12 mm
18 cm/7"



Cottle
Curved
34-13299-06
18 cm/7"
6 mm



Fomon
34-13302-05 5mm
34-13302-08 8mm
17 cm/6¾"



Walter
34-13306-03 3 mm
34-13306-04 4 mm
18 cm/7"



**(Silver)
Masing**
34-13310-01 34-13310-02 34-13310-03
17.5 cm/7⅞"



16 mm
Cinelli
34-13314-10 10 mm
34-13314-12 12 mm
34-13314-14 14 mm
34-13314-16 16 mm
16 cm/6¼"

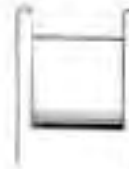

Masing
34-13318-17
17.5 cm/6⅞"



West
34-13322-16
16 cm/6¼"



West
34-13324-16
16 cm/6¼"



34-13328-01

34-13328-02

Joseph
17 cm/6¾"



Joseph
34-13330-01
17 cm/6¾"



Joseph
34-13332-02
17 cm/6¾"



Joseph
34-13332-03
17 cm/6¾"

TC

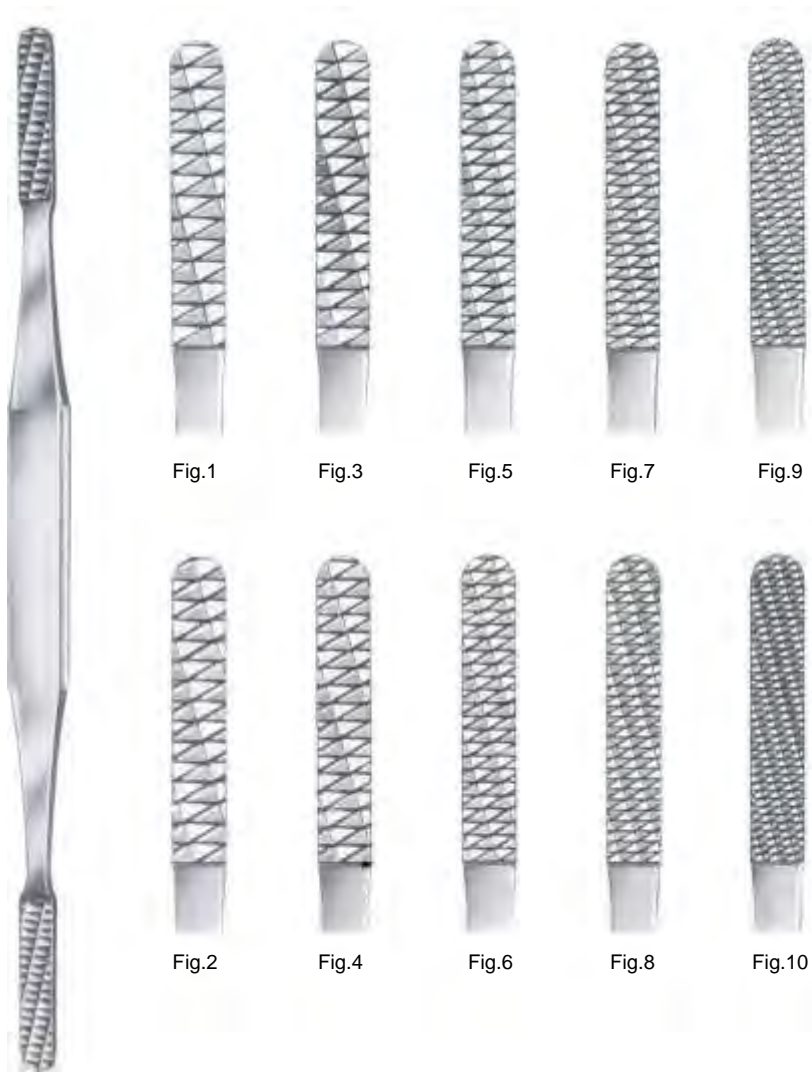

Fig.1 Fig.3 Fig.5 Fig.7 Fig.9
Fig.2 Fig.4 Fig.6 Fig.8 Fig.10

Famon

- Fig. 1/ 2 34-13336-12
 - Fig. 3/ 4 34-13336-34
 - Fig. 5/ 6 34-13336-56
 - Fig. 7/ 8 34-13336-78
 - Fig. 9/10 34-13336-90
- 21 cm/8¼"

TC



- | Parkes | | Maltz | |
|---------------|-------------|--------------|-------------|
| Fig. 1 | 34-13340-01 | Fig. 1 | 34-13344-01 |
| Fig. 2 | 34-13340-02 | Fig. 2 | 34-13344-02 |
| Fig. 3 | 34-13340-03 | Fig. 3 | 34-13344-03 |
| Fig. 4 | 34-13340-04 | Fig. 4 | 34-13344-04 |
| Fig. 5 | 34-13340-05 | Fig. 5 | 34-13344-05 |
| Fig. 6 | 34-13340-06 | Fig. 6 | 34-13344-06 |
| Fig. 7 | 34-13340-07 | Fig. 7 | 34-13344-07 |
| Fig. 8 | 34-13340-08 | Fig. 8 | 34-13344-08 |
| Fig. 9 | 34-13340-09 | Fig. 9 | 34-13344-09 |
| Fig. 10 | 34-13340-10 | Fig. 10 | 34-13344-10 |
| 20.5 cm/8¾" | | 17 cm/6¾" | |



Maltz
17 cm/6¾"



34-13348-01



34-13348-02

TC



Miller
16 cm/6¼"



34-13352-01



34-13352-02

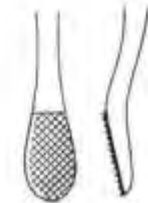
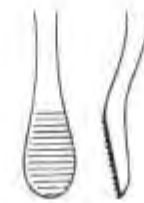

19 cm/7½"



34-13356-02



34-13356-03



34-13356-04



34-13356-05



34-13356-06



34-13356-07



Aufricht
34-13360-17
17.5 cm/6¾"

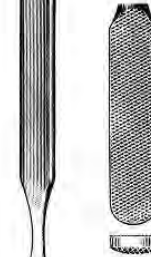
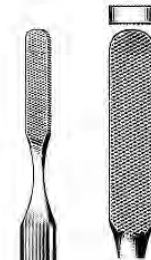

Fomon
34-13364-21
21 cm/8¼"

Rhinology Instruments Nasal Rasps



Maltz
34-13368-18
18 cm/7"



Joseph
16 cm/6¼"

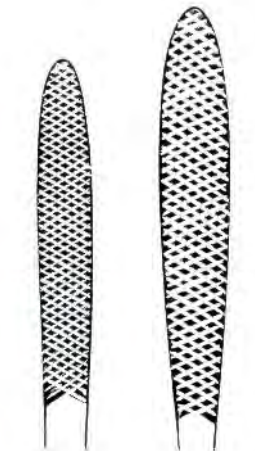

34-13372-01 34-13372-02



Lewis
18 cm/7"

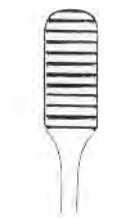

Fine
34-13376-01



Coarse
34-13376-02



Cottle
34-13380-21
21 cm/8¼"



34-13384-01



34-13384-02

Aufricht
21 cm/8¼"



Joseph
34-13388-16
15 cm/6"



Cottle
34-13392-16
15 cm/6¼"



Lange
34-13396-22
22 cm/8¾"



Fomon
34-13400-17
17 cm/6¾"



Freer
34-13404-15
15 cm/6"



Frazier
34-13408-13 13 cm/5"
34-13408-18 18 cm/7"



Joseph
16 cm/6¼"



34-13412-02
2 mm



34-13412-05
5 mm



34-13412-07
7 mm



34-13412-10
10 mm



Fomon
34-13416-16
16 cm/6¼"



**Neivert
(Masing)**
34-13420-20
20 cm/8"



Cottle-Neivert
34-13424-20
20 cm/8"

Hooks



Fomon
34-13428-14
14.5 cm/5 3/4"



Cottle
34-13432-14
14.5 cm/5 3/4"



Cottle
34-13434-14
14.5 cm/5 3/4"



Cottle
34-13436-14
14.5 cm/5 3/4"



Cottle
34-13440-16
15 cm/6"



Kilner
34-13444-08
8 cm/3 1/8"
10 mm



Columella Forceps

Converse
34-13448-12
12 cm/4 3/4"

Aufrecht
34-13452-16
16 cm/6 1/4"



Cottle
34-13456-10
10 cm/4"

Tissue Lifter



34-13460-14
14 cm/5 1/2"

Tissue Picks



34-13464-11
11 cm/4 3/8"



1.0 mm 34-13468-10
1.8 mm 34-13468-18



Walsham
23 cm/9"



34-13472-01



34-13472-02



34-13472-03



Cottle-Walsham
34-13474-22
22 cm/8¾"



Asch
34-13476-23
23 cm/9"



Kressner
34-13480-20
20 cm/8"



Rubin
34-13484-20
20 cm/8"



Faulkner
34-13488-21
21 cm/8¼"



Sewall
34-13492-20
20 cm/8"
6 mm



Coakley
17 cm/6¾"

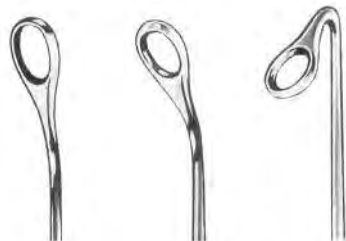

34-13496-01 34-13496-02 34-13496-03

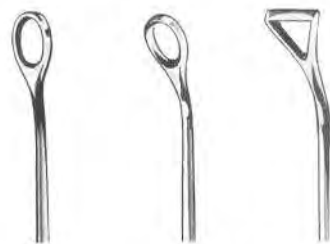

34-13496-04 34-13496-05 34-13496-06

Ringmesser



Beckmann
22 cm/8¾"

34-13500-01



34-13501-01

34-13500-02



34-13501-02

34-13500-03



34-13501-03

34-13500-04



34-13501-04

34-13500-05



34-13501-05

34-13500-06



34-13501-06

Adenoid Curettes



Negus
20 cm/8"

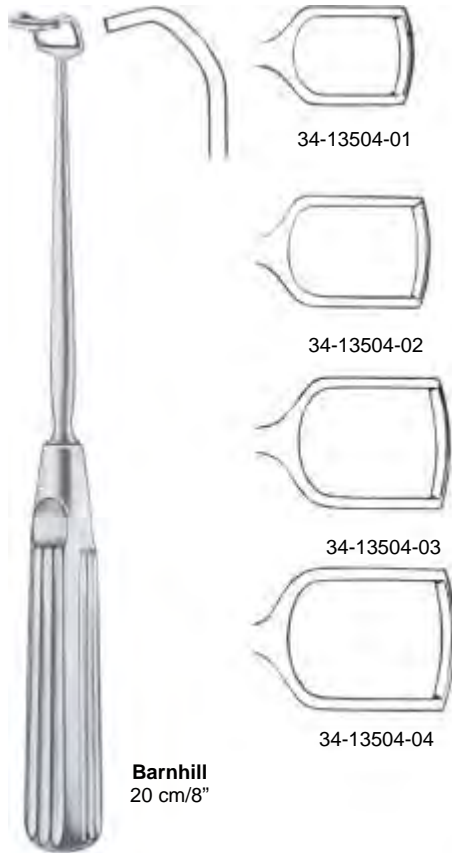

Barnhill
20 cm/8"

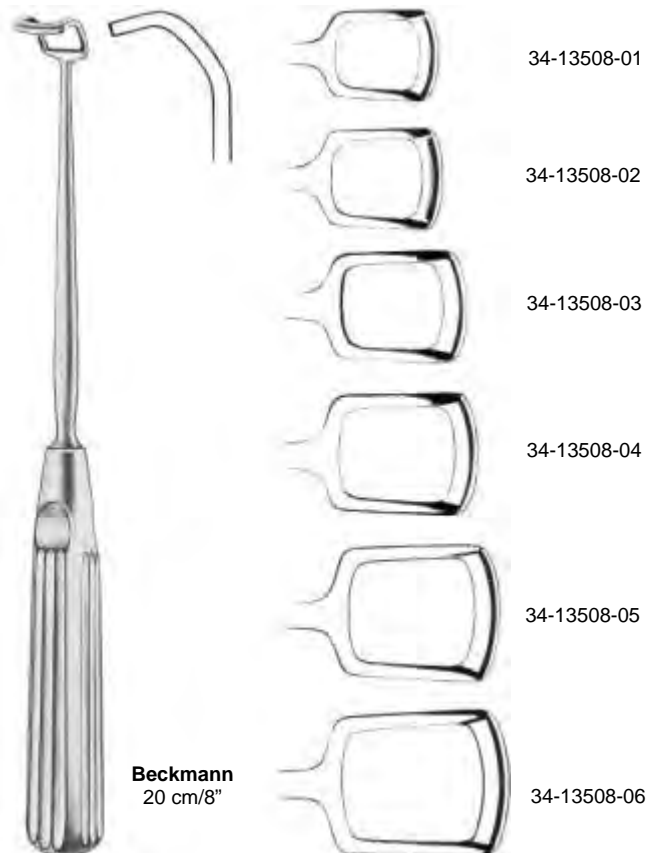

Beckmann
20 cm/8"



St. Clair-Thompson
22 cm/8¾"

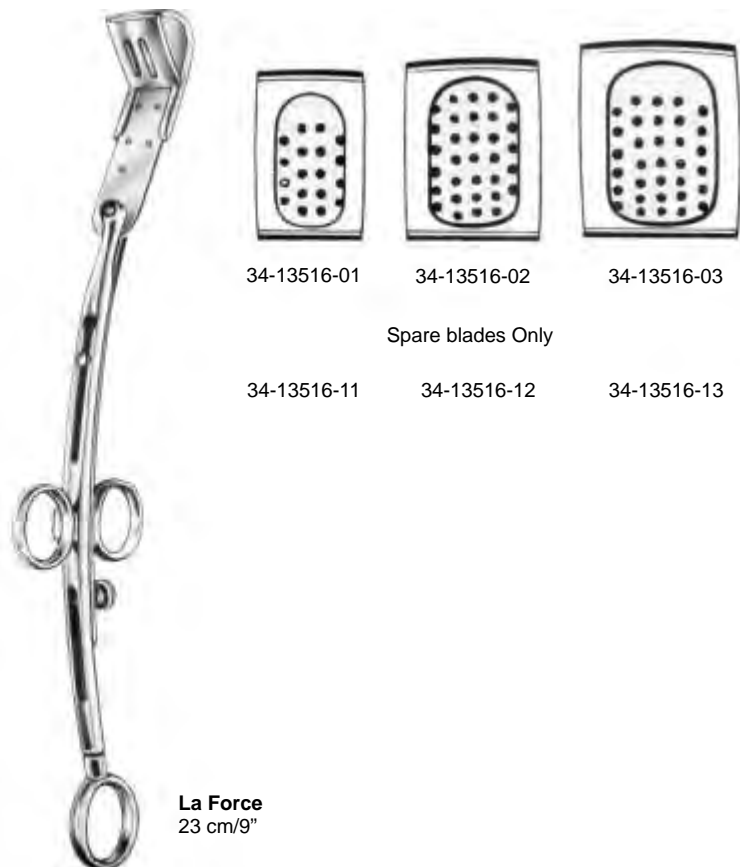

La Force
23 cm/9"



Bruenings- Brunk
34-13520-19
91 cm/7½"



Siebenmann



mm Ø

34-13524-15	1.5	34-13526-15
34-13524-17	1.7	34-13526-17
34-13524-20	2.0	34-13526-20
34-13524-25	2.5	34-13526-25
34-13524-30	3.0	34-13526-30



Hartmann

Fig. 1

mm Ø

Fig. 2

34-13530-20	34-13534-20
34-13530-25	34-13534-25
34-13530-30	34-13534-30



Eicken - Killian
34-13538-03
3 mm Ø



Killian
34-13538-15
1.5 mm Ø



Ritter - Halle
2.5 mm 34-13540-25
3.0 mm 34-13540-30
4.0 mm 34-13540-40

Gag Only
35-13546-10



Fig. 1
35-13546-01
65 x 28 mm

Kilner-Doughty
Complete
35-13546-00



Fig. 3
35-13546-03
80 x 37 mm

Fig. 2
35-13546-02
75 x 32 mm

Gag Only
35-13550-10

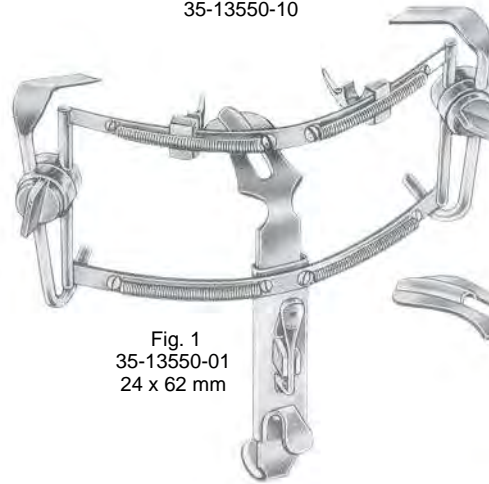

Fig. 1
35-13550-01
24 x 62 mm

Dingmann
Complete
35-13550-00



Fig. 3
35-13550-03
31 x 75 mm

Fig. 2
35-13550-02
28 x 65 mm

Gag Only
35-13554-10



Fig. 1
35-13554-01
21 x 26 mm

Davis-Boyle
Complete
35-13554-00



Fig. 2
35-13554-02
23 x 65 mm

Fig. 3
35-13554-03
24 x 80 mm

Fig. 4
35-13554-04
25 x 93 mm

Fig. 5
35-13554-05
26 x 108 mm

Gag Only
35-13558-10



Mc Ivor
Complete
35-13558-00



Fig. 1
35-13558-01
23 x 70 mm

Fig. 2
35-13558-02
25 x 86 mm

Fig. 3
35-13558-03
26 x 100 mm



Fig.	mm
2	35-13562-02 23 x 65
3	35-13562-03 24 x 80
4	35-13562-04 25 x 93
5	35-13562-05 26 x 108

Modell Wurzburg

Fig.	mm
1	35-13566-01 28 x 66
2	35-13566-02 32 x 75
3	35-13566-03 34 x 83
4	35-13566-04 37 x 93
5	35-13566-05 38 x 100



Chest Support for
Mouth gag
35-13570-00



Mouth Gags

Baby-Molt
35-13574-10
10 cm/4"

Molt
35-13576-11 11 cm/4¼"
35-13576-14 14 cm/5½"

Roser-Konig
35-13580-16 16 cm/6¼"
35-13580-19 19 cm/7½"

Denhart
35-13584-12
12 cm/4¾"



Heister
35-13588-13
13 cm/5"



Fergusson-Ackland
35-13592-18 18 cm/7"
35-13592-20 20 cm/8"



Whitehead
35-13596-11 11 cm/4¼"
35-13596-13 13 cm/5"
35-13596-15 15 cm/6"

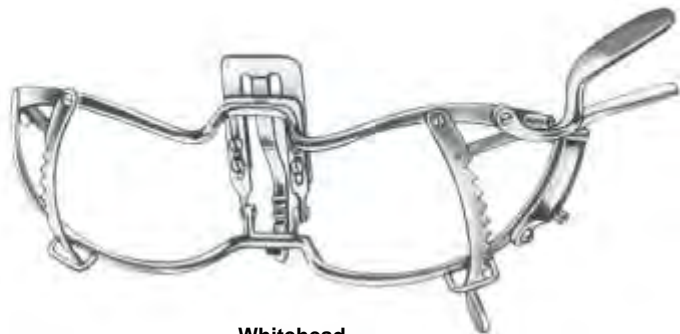

Whitehead
35-13600-13
13 cm/5"



Jennings
35-13604-09 09 cm/3½"
35-13604-11 11 cm/4¼"
35-13604-13 13 cm/5"
35-13604-15 15 cm/6"



Sternberg
35-13608-12 12 cm/4¾"
35-13608-14 14 cm/5½"
35-13608-16 16 cm/6¼"



35-13612-19
19 cm/7½"



Moritz-Schmidt
35-13616-19
19 cm/7½"



Hartmann
35-13620-15
15 cm/6"



Tobold
35-13624-14
14.5 cm/5¾"



Fraenkel
35-13628-19
19 cm/7½"



Frenzel
35-13632-16
16.5 cm/6½"



35-13636-13
13 cm/5"



35-13640-14
14.5 cm/5¾"



35-13646-14
14.5 cm/5¾"



Kroenig
35-13650-15
15 cm/6"



Mayo
35-13654-17
17 cm/6¾"



Bruenings
35-13658-19
19 cm/7½"



Bruenings
35-13662-19
19 cm/7½"



35-13666-01



35-13666-02

Wieder

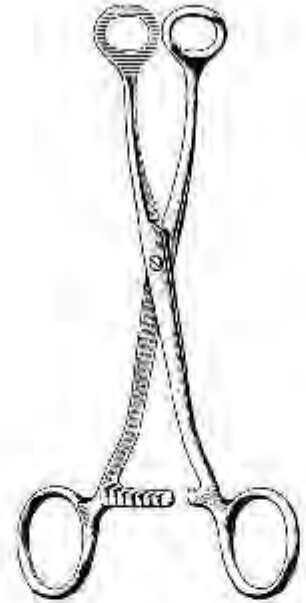

Collin
35-13670-16
16 cm/6¼"



Collin
35-13672-19
19 cm/7½"



35-13676-19
19 cm/7½"



Young
35-13680-17
17 cm/6¾"



Guys
35-13682-19
19 cm/7½"

Finger Protectors



Lengenbeck
35-13684-01 Ø 22.0 mm
35-13684-02 Ø 24.5 mm
35-13684-03 Ø 26.5 mm

Tonsil Instruments Tonsil Needles and Ligature Carriers

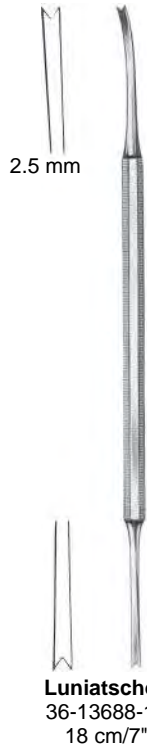



36-13728-17
17.5 cm/6⁷/₈"



Fischer
36-13732-22
22.5 cm/8⁷/₈"



Douglas
36-13736-21
21 cm/8¹/₄"



Abraham
36-13740-21
21 cm/8¹/₄"



Bruenings
36-13744-23
23 cm/9"



Abraham
36-13748-19
19 cm/7¹/₂"



Canfield
36-13752-21
21 cm/8¹/₄"



Hurd
36-13756-22
22.5 cm/8⁷/₈"



Yankauer
36-13760-21
21 cm/8¹/₄"



Luniatschek
36-13764-19
19 cm/7¹/₂"



Henke
23 cm/9"



36-13768-01



36-13768-02



Nager
36-13772-23
23 cm/9"



Wide
36-13776-18 18 mm
36-13776-20 20 mm
36-13776-22 22 mm



Love
23 cm/9"



Haslinger
36-13780-16

Hofer
36-13784-24
24 cm/9¹/₂"

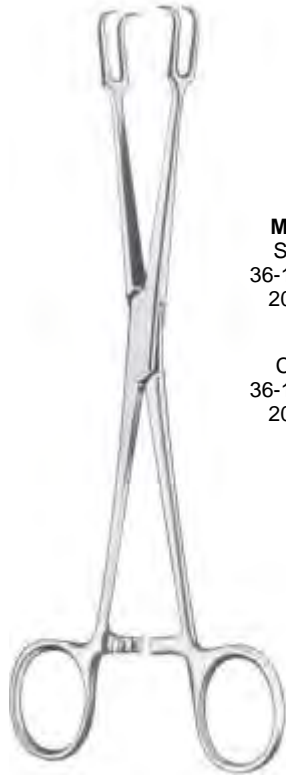

Museux
Straight
36-13788-20
20 cm/8"

Curved
36-13789-20
20 cm/8"



Ballenger
36-13792-21
21.5 cm/8½"



White
36-13796-18 18 cm/7"
36-13796-23 23 cm/9"



Marschik Kroni
36-13800-20
20.5 cm/8"



Colver
Straight
36-13804-19
19 cm/7½"

Curved
36-13805-19
19 cm/7½"



Blohmke
36-13808-20
20 cm/8"



Eves
36-13812-28
28 cm/11"



Eves
36-13814-28
28 cm/11"



Bruenings
36-13818-28
28 cm/11"

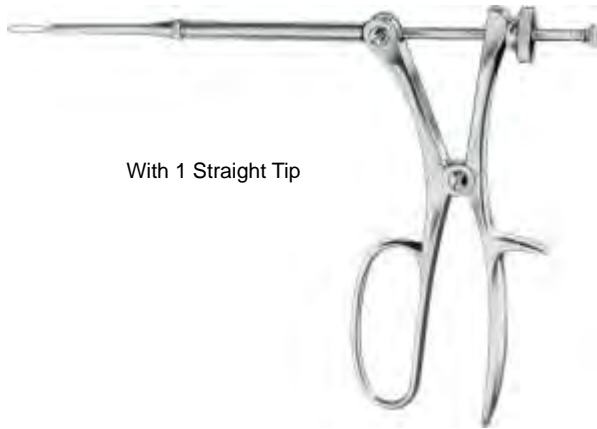

With 1 Straight Tip

Brown
36-13822-00

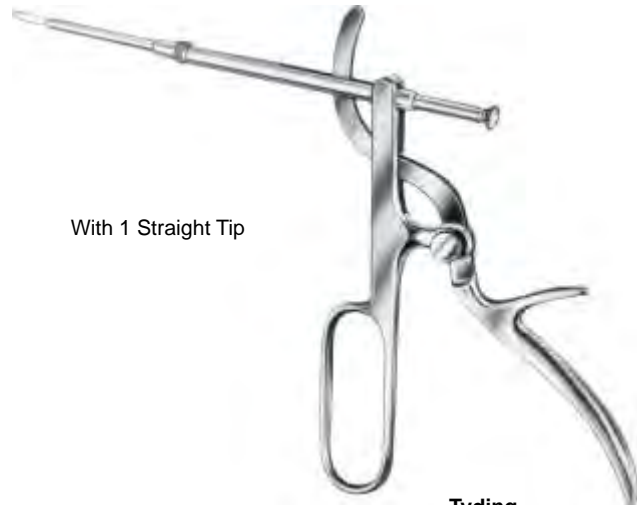

With 1 Straight Tip

Tyding
36-13826-00



Sluder-Ballenger
Complete, With 3 Tips
36-13830-00



Tonsil Punch Forceps

36-13834-13 13 mm Ø
36-13834-15 15 mm Ø
36-13834-17 17 mm Ø



















Hartmann

Tonsil Haemostats















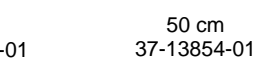



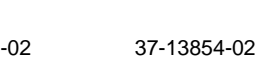
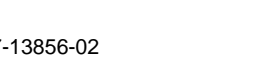

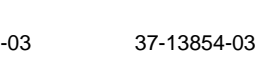



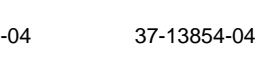
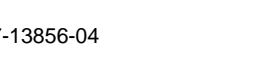

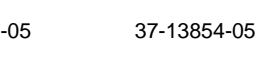



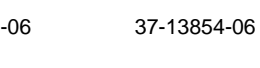
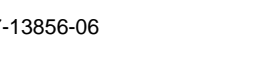

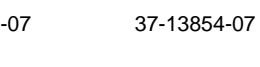



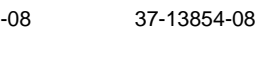



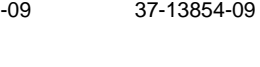

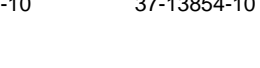
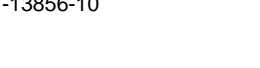

Corwin
36-13838-14
14 cm/5½"

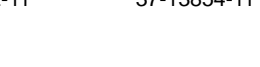

	Micro Scissors	Micro Forceps	Cup Shaped Forceps 2.5 mm Ø
Straight	 37-13842-01	 37-13844-01	 37-13846-01
Straight Horizontal	 37-13842-02	 37-13844-02	
Angled Up	 37-13842-03	 37-13844-03	 37-13846-03
Angled Up Horizontal	 37-13842-04	 37-13844-04	 37-13846-04
Curved Right	 37-13842-05	 37-13844-05	 37-13846-05
Curved Left	 37-13842-06	 37-13844-06	 37-13846-06
			 Oval 37-13846-07



Length of Shaft

Length of Shaft For Children	40 cm	50 cm	60 cm
 35 cm 37-13850-01	 40 cm 37-13852-01	 50 cm 37-13854-01	 60 cm 37-13856-01
 37-13850-02	 37-13852-02	 37-13854-02	 37-13856-02
 37-13850-03	 37-13852-03	 37-13854-03	 37-13856-03
 37-13850-04	 37-13852-04	 37-13854-04	 37-13856-04
 37-13850-05	 37-13852-05	 37-13854-05	 37-13856-05
 37-13850-06	 37-13852-06	 37-13854-06	 37-13856-06
 37-13850-07	 37-13852-07	 37-13854-07	 37-13856-07
 37-13850-08	 37-13852-08	 37-13854-08	 37-13856-08
 37-13850-09	 37-13852-09	 37-13854-09	 37-13856-09
 37-13850-10	 37-13852-10	 37-13854-10	 37-13856-10
 37-13850-11	 37-13852-11	 37-13854-11	 37-13856-11
	 37-13852-12	 37-13854-12	 37-13856-12
	 37-13852-13	 37-13854-13	 37-13856-13



Chevalier-Jackson



Length
cm in

30	12	37-13860-30	37-13862-30	37-13864-30	37-13866-30	37-13868-30	37-13870-30	37-13872-30	37-13874-30
40	16	37-13860-40	37-13862-40	37-13864-40	37-13866-40	37-13868-40	37-13870-40	37-13872-40	37-13874-40
50	20	37-13860-50	37-13862-50	37-13864-50	37-13866-50	37-13868-50	37-13870-50	37-13872-50	37-13874-50
60	24	37-13860-60	37-13862-60	37-13864-60	37-13866-60	37-13868-60	37-13870-60	37-13872-60	37-13874-60

Interchangeable Tips

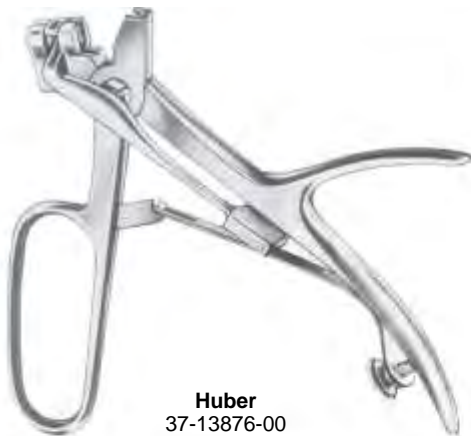

Huber
37-13876-00



Bruenings
37-13880-00



Straight		Lengths		Angular	
cm	in	cm	in	cm	in
37-13884-20	20	08	37-13885-20	20	08
37-13884-30	30	12	37-13885-30	30	12
37-13884-40	40	16	37-13885-40	40	16
37-13884-50	50	20	37-13885-50	50	20
37-13884-60	60	24	37-13885-60	60	24

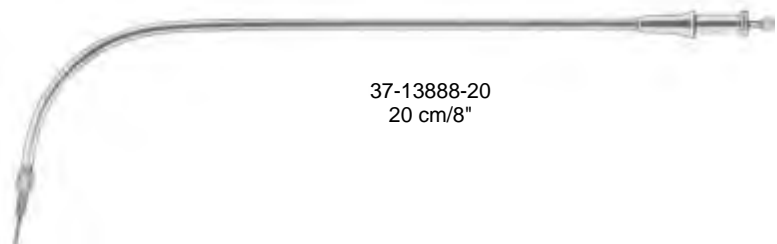

37-13888-20
20 cm/8"



Baracani
37-13890-01



Seiffert
37-13892-01



Frankel
37-13894-01



Scheinmann
37-13896-01



Scheinmann
37-13896-02



Bruenings
37-13898-01 2 mm Ø
37-13898-02 3 mm Ø



Bruenings
37-13898-03



Bruenings
37-13898-04



Lange
37-13900-01



Krause
37-13902-01



Krause
37-13904-01



Cordes
37-13906-01



Schumacher
37-13908-01



Cordes

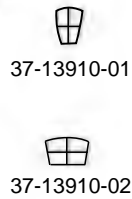

Flatau
37-13912-01



Fraenkel
37-13914-01



Fig.	mm Ø
000	06
00	08
0	10
1	12
2	14
3	16
4	18
5	20
6	22
7	24
8	26
9	28
10	30

37-13916-06
37-13916-08
37-13916-10
37-13916-12
37-13916-14
37-13916-16
37-13916-18
37-13916-20
37-13916-22
37-13916-24
37-13916-26
37-13916-28
37-13916-30

37-13918-06
37-13918-08
37-13918-10
37-13918-12
37-13918-14
37-13918-16
37-13918-18
37-13918-20
37-13918-22
37-13918-24
37-13918-26
37-13918-28
37-13918-30

Michel
37-13920-10
37-13920-12
37-13920-14
37-13920-16
37-13920-18
25 cm/10"

37-13924-01

Metal Handles

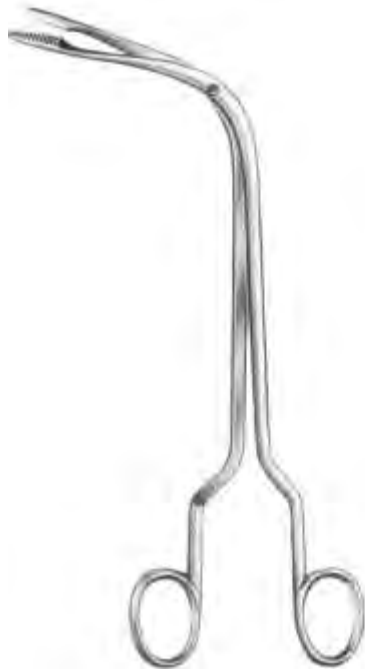

Fraenkel
37-13928-18
18 cm/7"

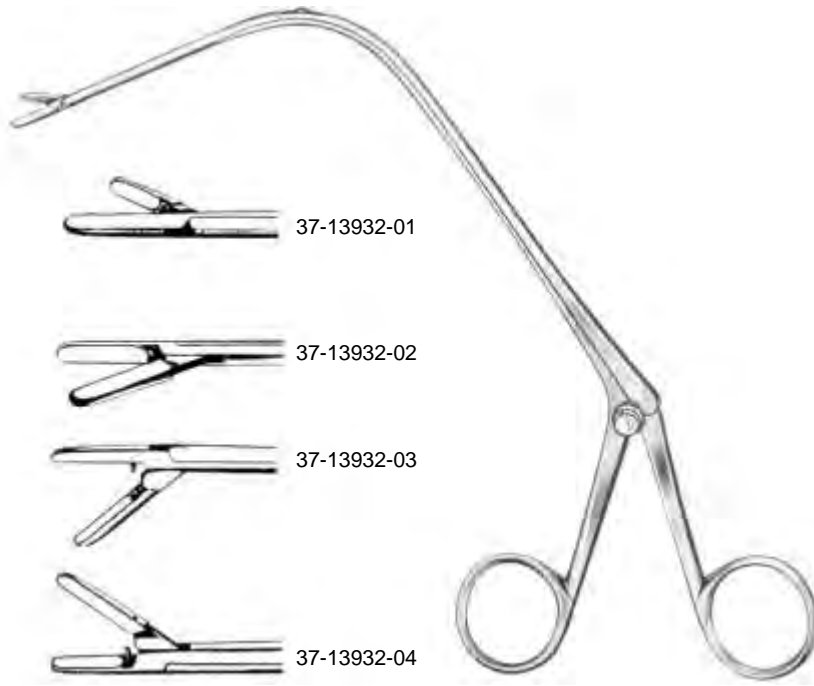

Jurasz
23 cm/9"

- 37-13932-01
- 37-13932-02
- 37-13932-03
- 37-13932-04



Epiglottis Retractor

Reichert
37-13936-24
24 cm/9½"



Killian
37-13940-20
20 cm/8"



Davis
38-13944-16 16 cm/6¼"
38-13944-24 24 cm/9½"



Sauerbruch
38-13948-55
55 cm/21½"



38-13952-20 20 cm/8"
38-13952-28 28 cm/11"
38-13952-30 30 cm/12"



Rogge
38-13956-23
23 cm/9"



Cheatle
38-13960-27
27 cm/10½"



Universal
38-13964-20 20 cm/8"
38-13964-28 28 cm/11"



Universal
38-13968-20
38-13968-28



Bunt
38-13972-01
10.5 cm/4¼"



Mayo
38-13972-02
14 cm/5½"



Mayo
38-13972-03
14 cm/5½"

Stainless



39-13976-15
15 cm/6"



39-13980-10
39-13981-10
10 cm/4"

Straight
Curved



39-13984-10
39-13985-10
10 cm/4"



39-13992-10
10 cm/4"



39-13996-11
11 cm/4½"
39-13996-13
13 cm/5"

Asepsis Nail Nippers



cm	in	
11	4½"	39-14000-11
13	5"	39-14000-13
14	5½"	39-14004-14
16	6¼"	39-14004-16



cm	in	
11	4½"	39-14012-11
13	5"	39-14012-13
14	5½"	39-14008-14
15	6"	39-14008-15
		39-14012-15

Holloware

Needle Case, Endodontic Box, Tube Rack, Cotton Holder
Sprit Lamp, Cup, Fennle and Jars



Needle Case Round with Cover
40-14101-01 65x15mm



Needle Case Round
40-14102-01 80x20mm



Needle Case Rectangle
40-14103-01 70x70x10mm



Endodontic Box
40-14104-01
100x40x50mm

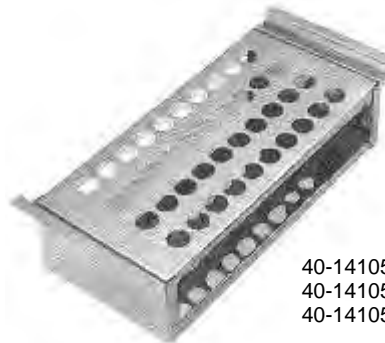

Tube Rack

40-14105-01 6.35x15.25x5cm for 12 tubes
40-14105-02 6.35x17.75x7.5cm for 27 tubes
40-14105-03 7.50x17.75x6.35cm for 36 tubes



Sprit Lamp
40-14106-01
Standard Size



Sprit Lamp
40-14107-01
Standard Size



Sputum Cup
40-14108-01 75x80mm
40-14108-02 100x50mm
40-14108-03 100x80mm



Dressing Jar

40-14109-01	80x60mm	40-14110-01
40-14109-02	80x80mm	40-14110-02
40-14109-03	100x100mm	40-14110-03
40-14109-04	120x120mm	40-14110-04
40-14109-05	150x150mm	40-14110-05
40-14109-06	180x180mm	40-14110-06
40-14109-07	200x200mm	40-14110-07



Dressing Jar



Fennle
40-14112-01 100mm Ø
40-14112-02 120mm Ø
40-14112-03 150mm Ø
40-14112-04 200mm Ø



Cotton Holder
40-14111-01

Holloware

Jars, Jallipot, Bowls, Cups, Kidney Trays



Forceps Jar

- 40-14113-01 30x90mm
- 40-14113-02 50x125mm
- 40-14113-03 50x170mm
- 40-14113-04 50x200mm
- 40-14113-05 40x230mm
- 40-14113-06 70x110mm
- 40-14113-07 80x150mm
- 40-14113-08 100x200mm
- 40-14113-09 150x30mm



Medicine Cup

- 40-14118-01 50ml
- 40-14118-02 60ml
- 40-14118-03 70ml



Kick Bucket with Trolley

- 40-14119-01
- 390x280x180mm



Gallipot

- | | |
|-------------------|-------------------|
| 40-14114-01 01 oz | 40-14114-09 09 oz |
| 40-14114-02 02 oz | 40-14114-10 10 oz |
| 40-14114-03 03 oz | 40-14114-11 11 oz |
| 40-14114-04 04 oz | 40-14114-12 12 oz |
| 40-14114-05 05 oz | 40-14114-13 13 oz |
| 40-14114-06 06 oz | 40-14114-14 14 oz |
| 40-14114-07 07 oz | 40-14114-15 15 oz |
| 40-14114-08 08 oz | 40-14114-16 16 oz |



Sponge Bowl

- 40-14115-01 12 cm
- 40-14115-02 15 cm
- 40-14115-03 20 cm



Lotion Bowl without spout

- | | |
|----------------------|-----------------------|
| 40-14116-01 40x19mm | 40-14116-08 150x65mm |
| 40-14116-02 50x25mm | 40-14116-09 180x85mm |
| 40-14116-03 60x30mm | 40-14116-10 200x100mm |
| 40-14116-04 80x40mm | 40-14116-11 250x120mm |
| 40-14116-05 100x50mm | 40-14116-12 300mm |
| 40-14116-06 120x60mm | 40-14116-13 350mm |
| 40-14116-07 140x60mm | 40-14116-14 400mm |



Wash Basin

- 40-14117-01 300x80mm
- 40-14117-02 320x85mm
- 40-14117-03 330x90mm
- 40-14117-04 350x110mm
- 40-14117-05 400x115mm



Kidney Tray

- 40-14121-01 12cm
- 40-14121-02 15cm
- 40-14121-03 18cm
- 40-14121-04 20cm
- 40-14121-05 25cm
- 40-14121-06 28cm
- 40-14121-07 30cm



Kidney Tray Shallow

- 40-14120-01 17cm
- 40-14120-02 22cm
- 40-14120-03 24cm



Kidney Tray (with cover)

- 40-14122-01 15cm
- 40-14122-02 20cm
- 40-14122-03 25cm
- 40-14122-04 30cm

Holloware Instrument's Trays

40

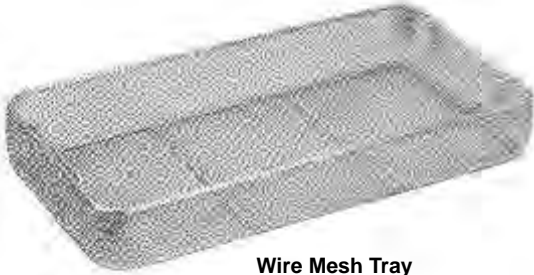

Wire Mesh Tray

- 40-14123-01 240x250x5mm
- 40-14123-02 480x250x5mm
- 40-14123-03 550x250x5mm
- 40-14123-04 240x250x7mm
- 40-14123-05 480x250x7mm
- 40-14123-06 240x250x10mm
- 40-14123-07 480x250x10mm



Wire Mesh Tray with Lid

- 40-14124-01 240x250x5mm
- 40-14124-02 480x250x5mm
- 40-14124-03 550x250x5mm
- 40-14124-04 240x250x7mm
- 40-14124-05 480x250x7mm
- 40-14124-06 240x250x10mm
- 40-14124-07 480x250x10mm



Perforated Tray

- 40-14125-01 200x100x40mm
- 40-14125-02 250x120x50mm
- 40-14125-03 300x150x50mm
- 40-14125-04 350x170x50mm
- 40-14125-05 400x200x50mm



Instruments Tray without Lid

- 40-14126-01 100x150x25mm
- 40-14126-02 150x200x40mm
- 40-14126-03 200x250x45mm
- 40-14126-04 250x300x50mm
- 40-14126-05 300x350x50mm
- 40-14126-06 150x300x50mm
- 40-14126-07 200x300x50mm
- 40-14126-08 230x150x50mm



Instruments Tray with Lid

- 40-14127-01 100x150x25mm
- 40-14127-02 150x200x40mm
- 40-14127-03 200x250x45mm
- 40-14127-04 250x300x50mm
- 40-14127-05 300x350x50mm
- 40-14127-06 150x300x50mm
- 40-14127-07 200x300x50mm
- 40-14127-08 230x150x50mm



Burr Tray
40-14128-01
190x100x20mm



Cathetes Tray with Lid
40-14129-01 300x80x40mm
40-14129-02 350x90x45mm
40-14129-03 400x100x50mm



Scaler Tray with cover
40-14130-01
200x100x16mm

Holloware Instrument's Boxes, Drums and Sterilizers



Instruments Box

- 40-14131-01 170x70x30mm
- 40-14131-02 180x80x40mm
- 40-14131-03 200x100x40mm
- 40-14131-04 230x120x50mm
- 40-14131-05 250x125x50mm
- 40-14131-06 300x150x50mm
- 40-14131-07 350x170x50mm
- 40-14131-08 400x200x90mm
- 40-14131-09 500x200x120mm



**Instruments Box
with Hooks**

- 40-14132-01 170x70x30mm
- 40-14132-02 180x80x40mm
- 40-14132-03 200x100x40mm
- 40-14132-04 230x120x50mm
- 40-14132-05 250x125x50mm
- 40-14132-06 300x150x50mm
- 40-14132-07 350x170x50mm
- 40-14132-08 400x200x90mm
- 40-14132-09 500x200x120mm



**Instruments Box
Perforated**

- 40-14133-01 200x100x40mm
- 40-14133-02 250x150x40mm
- 40-14133-03 300x150x40mm



Electric Sterilizer

- 40-14134-01 200x100x120mm
- 40-14134-02 250x120x140mm
- 40-14134-03 300x150x150mm
- 40-14134-04 350x170x170mm
- 40-14134-05 400x200x180mm
- 40-14134-06 450x230x190mm



Non Electric Sterilizer

- 40-14135-01 200x100x65mm
- 40-14135-02 250x125x65mm
- 40-14135-03 300x150x100mm
- 40-14135-04 350x170x65mm
- 40-14135-05 400x200x100mm

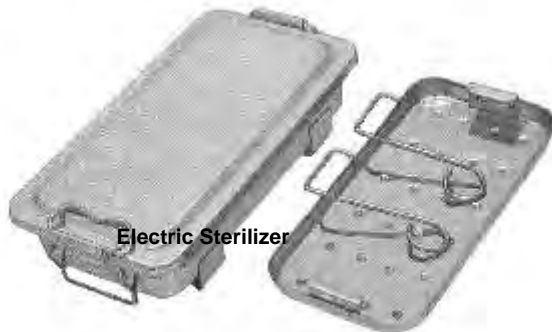

Electric Sterilizer

- 40-14136-01
280x125x65mm

- 40-14137-01 125x80mm
- 40-14137-02 125x120mm
- 40-14137-03 150x100mm
- 40-14137-04 150x150mm
- 40-14137-05 180x180mm
- 40-14137-06 190x140mm
- 40-14137-07 190x190mm
- 40-14137-08 200x200mm
- 40-14137-09 240x120mm
- 40-14137-10 240x240mm
- 40-14137-11 290x140mm
- 40-14137-12 290x240mm
- 40-14137-13 290x290mm
- 40-14137-14 340x160mm
- 40-14137-15 340x340mm
- 40-14137-16 390x150mm
- 40-14137-17 390x200mm
- 40-14137-18 390x290mm



Sterilizer Drum

Holloware
Bedpan

40



Bedpan Hand Made
40-14138-01
Standard



Bedpan Hand Made
40-14139-01 Adult
40-14139-02 Child



Bedpan Hand Made
40-14140-01
Standard



Bedpan Simple
pressed body with handle
40-14142-01 Adult
40-14142-02 Child



Bedpan Sleeper Type
40-14143-01 Adult
40-14143-02 Child



Bedpan Chamber Port
40-14144-01
Standard

Holloware

Bedpan, Jug, Bucket, Irrigator and Dustbin

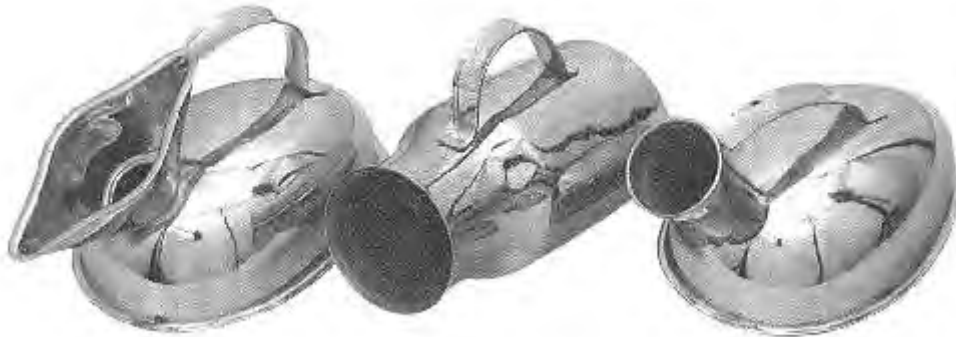

Urinal Female
40-14145-01
Standard

Urinal Male Vertical
40-14146-01
Standard

Urinal Male
40-14147-01
Standard



Bedpan perfection type seamless
40-14148-01
350x300mm



Bedpan perfection type
40-14149-01 370x290mm
40-14150-01 320x240mm



Pail/Bucket with Lid
40-14153-01 06 Ltr
40-14153-02 10 Ltr
40-14153-03 15 Ltr



Dustbin
40-14151-01 210mm
40-14151-02 240mm
40-14151-03 270mm
40-14151-04 300mm



Measuring Jug
40-14152-01 0.5 Ltr
40-14152-02 1.0 Ltr
40-14152-03 1.5 Ltr
40-14152-04 2.0 Ltr



Douch Can/Irrigator
40-14154-01 1.0 Ltr
40-14154-02 1.5 Ltr
40-14154-03 2.0 Ltr

	Pages #		Pages #
BARNES-NEVILLE .Obstetrical Forceps	411	Holding Forceps	292-296
BARNHILL .Adenoid Curettes	613	Instruments	258-324
BARON-SCHUKNECHT .Suction Tubes	568	Lavers	282-289
BARR ,Rectal Speculas	345	Osteotomes	258-263
BARRAQUER .Anterior Chamber Forceps	492	Rasps	273
Cilia Forceps	11	Retractors	162-163
Eye Speculas	459	Rongeur Forceps	299-306
Fixation Forceps	504	Wires	319
Micro Needle Holders TC	227	Wire Guides	319
Micro Scissors	65	Wire Tighteners	319
Suture Forceps	488	BONN ,Eye Scissors	82
BARRAQUER-COLIBRI .Eye Speculas	459	Iris Forceps	493
Iris Forceps	492,494	Iris Hooks	471
ARRAQUER-KATIN (COLIBRI) .Fixation Forceps	497	Irrigating Cannulas	478
BARRETT ,Tenaculum Forceps	385	Lachrymal Cannulas	481
BARSKY .Retractors	153	BONNEY .Dressing	97
BARTH .Bone Curettes	271,585	Tissue Forceps	106
Basiotribes	408	BORES .Corneal Fixation Forceps	501
BEACHAM .Amniotome	386	Corneal Markers	487
BEAUPRE .Cilia Forceps	109	Marking Instruments	487
BECK ,Anastomosis Clamps	451	BOSE ,Retractors	190,325
Atrauma Cardiovascular Forceps	438	Trachea Dilators	325
BECKER .Cystotomes	470	Trachea Hooks	325
BECKMANN ,Adenoid Curettes	612-613	BOUCHERON ,Ear Speculas	565
Nasal Speculas	590	BOWDLER-HENRY'S .Osteotomes,	188
BECKMANN-ADSON ,Retractors	195-196	BOWLES .Stethoscopes	1
BECKMANN-EATON ,Retractors	197	BOWMANN .Dissection Knives	467
BEEBEE ,Crown Scissors	91	Dissection Needles	469
BEER .Cilia Forceps	110	Eye Speculas	459
BEESON .Plaster Spreaders	256	Lachrymal Probes	484
BELLUCCI .Micro Scissors	573,575	BOYNTON .Needle Holders	226
BENGOLA .Hemostatic Forceps	125	Needle Holders TC	242
BENNETT .Bone Levers	289	BOYS-ALLIS .Intestinal Tissue Forceps	330
Cilia Forceps	109	BOZEMANN .Dressing Forceps	147
BENSAUDE .Anuscopes	345	Loop Twisters	254
BENSON ,Pylorus Spreaders	339	Needle Holders	235
BERENS .Keratomes	466	BOZEMANN-DOUGLAS .Cotton Swab Forceps	148
Scleral Hooks	472	Brain,Knives	28
BERGER .Cervical Biopsy and Specimen Forceps	394	Spatulas	520-521
BERGMAN ,Bandage Scissors	88	BRAND ,Tendon Seizing Instruments	122
Operating Knives	25	Tendon Strippers	322
Retractors	156	BRAUN .Cranioclats	408
BERKE .Advancement Forceps	490	Decapitating Hooks	408
BERLINER ,Percussion Hammers	2	Tenaculum Forceps	385,387
BERNHARD .Towel Forceps	143	Uterine Depressors	382
BETHUNE ,Rib Shears	412	Vaginal Speculas	373-374
BEYER .Bone Rongeurs	301,303	BRAUN-STADLER .Perineum Scissors	62
BILL ,Traction Handles	410	Perineum Scissors,SuperCut	37
BILLEAU ,Ear Loops	585	BREISKY .Pelvimeters	405
BINKHORST .Capsular Forceps	498	Vaginal Speculas	377
Irrigating Cannulas	478	BRIDGE ,Hemostatic	126
Biopsy,Forceps	393-398	BRISTOW .Bone Levers	288
Aspirating Curettes	391-392,401	BRODIE .Probes	210
BIRCHER ,Meniscotomy Knives	291	Broncho-Esophagoscopy Instruments	628-631
BIRCHER-GANSKE .Bone Holding Forceps	293	Bronchus Forceps	127,421
BIRKETT .Haemostatic Forceps	125	BROPHY .Dressing Forceps	97
BISHOP .Iris Forceps	493	Scissors	52
Bladder Retractors	361-362	Tissue Forceps	104
BLAKE(ZWEIFEL) ,Uterine Curettes	404	BROWN .Needle Holders	229
BLAKE .Gall Stone Forceps	356	Snare	624
BLASCOVICS .Muscle Forceps	490	Tissue Forceps	103
Blindgut Forceps	339	BRUENINGS .Septum Forceps	595
Blood Vessel Clamps	421-422	Septum Knives	600
BLOHMKE ,Tonsil Seizing Forceps	623	Tips	629
BLOUNT ,Bone Levers	289-290	Tongue Depressors	619
Meniscus Retractors	172	Tonsil Knives	621
BLUMENTHAL ,Bone Rongeurs Forceps	301	Tonsil Snare	624
BOETTCHER .Tonsil Scissors	60	Universal Handles	628
BOHLER .Bone Cutting Forceps	307	BRUENINGS-BRUNK ,Antrum Retractors	614
Bone Rongeur Forceps	303	BRUNETTI .Chisels	31
Extension Bows	317	BRUNNER .Intestinal Clamps Forceps	336
BONACCOITO ,Suture Forceps	489	Ligature Conductors	251-252
Bone Chisels	258-263	Ligature Needles	251
Curettes	265-272	Retractors	176
Cutting Forceps	307-308	Rib Shears	412
Files	273	BRUNNER-FERROZELL .Conductors	253
Gouges	258-264	BRUNS .Bandage Scissors	89
Hand Drills	311	Bone Curettes	266-267
Holding Clamps	298	BRYANT .Cotton Swab Forceps	145

	Pages #		Pages #
BUCK .Ear Curettes	585	Chest Support For Mouth Gags	616
Foreign Body Levers	570	CHEVALIER-JACKSON , Broncho-Esophagoscopy Forceps	628
Percussion Hammers	2	Trachea Tubes	326
BUCK-GRAMCKO .Bone Levers	284	CHILD ,Intestinal Clamp Forceps	332
BUCKINGHAM .Hand Instruments	582	Wound Suture Forceps	255
BUELAU .Trocars	7	Chisels	264,603-605
BUIE ,Clamp Forceps	137	Cilia Forceps	109-110
Probes	211	CINELLI .Chisels	604
Rectal Aspiration Cannulas	349	Circumcision Instruments	365
Bulldog Clamps	115,149	CITELLI .Ear Punch	584
Atrauma	149	CITELLI-BEYER .Ear Punch	584
BUMM .Uterine Curettes	404	Clamps	137-139
BUNGE .Exenteration Scoops	477	CLAUS .Tonsil Needles	620
BUNT ,Waste Clamps	632	CLAUS-EICKEN ,Tonsil Needles	620
BURCH ,Fixation Hooks	469	Cleft Palate Knives	621
BURKE ,Cervical Biopsy and Specimen Forceps	397	CLEVELAND ,Bone Cutting Forceps	307
BURFORD .Rib Spreaders	419	Bone Rongeur Forceps	300
BUSCH ,Umbilical Scissors	62	Clip Applying Forceps	255
BUSCHE .Bone Curettes	270	Clothing Scissors	90
		CLOWARD .Bone Chisels	259
		Bone Gouges	259
		Lamina Spreaders	512-513
		Nerve Retractors	524
		COAKLEY .Curettes	612
		Trocars	8
		Coarctation Clamps	443-449
		COBB ,Gouges	264
		Periosteal Raspatories	271,281
		COLCLOUGH ,Rongeur Forceps	529
		Collar Button Cannulas	482
		COLLER-CRILE .Hemostatic Forceps	120
		COLLIER ,Needle Holders	229
		COLLIN .Abdominal Retractors	198-199
		Clip Applying Forceps	255
		Cotton Swab Forceps	147
		Dynamometers	5
		Hemostatic Forceps	116
		Pelvimeters	405
		Retractors	161
		Rib Shears	90
		Tongue Forceps	619
		Umbilical Cord Clamps	408
		Uterine Curettes	400
		Uterine Elevating Forceps	389
		Uterine Sounds	382
		Vaginal Speculas	367
		COLLIN-DUVAL .Grasping Forceps	105
		COLLIN-HARTMANN ,Retractors	160
		COLLIN-LANDAU .Vaginal Speculas	367
		COLLIN-POZZI Jenaculum Forceps	385
		COLLYER ,Pelvimeters	405
		Columella Forceps	610
		COLVER .Tonsil Seizing Forceps	623
		Comedone Extractors	328
		Conductors	506
		CONE(ADSON-BABY) ,Retractors	193
		CONE ,Knives	390
		Retractors	194
		Conjunctival Forceps	495
		CONNEL ,Airways	14
		CONNIN-AMSLER .Marking Instruments	483
		CONVERSE .Needle Holders TC	237
		Rhinoplastic Hooks	610
		Rhinoplastic Knives	599
		CONWAY .Lid Retractors	463
		COOK .Eye Speculas	461
		COOLY ,Anastomosis Clamps	451
		Aortic Dilators	458
		Atrauma Dissecting Forceps	423
		Atrauma Pediatric Clamps	453
		Carotid Clamps	448
		Coarctation Clamps	449
		Ligature Clamps	452
		Multi Purpose Clamps	450
		Retractors	181
		Rib Shears	415,418
		Suction Tubes	456
		Vascular Dilators	457
		COOLY-DERRA .Atrauma Cardiovascular Forceps	452

C

Calipers	5
analiculus Knives	467
CANFIELD .Tonsil Knives	621
Cannulas	15,478-482
CAPLAN ,Septum Forceps	597
Capsular Forceps	496-498
Capsule Polishing Instruments	480
Cardiovascular.Forceps	421-455
Instruments	412-458
CAROLL .Goniometers	5
Tendon Seizing Instruments	324
Carotid Clamps	448-449
CARREL ,Hemostatic Forceps	115
Cartilage,Knives	29
Scissors	58
CASPER .Lamina Spreader	510-511
Micro Dissectors	557-559
Retractors	169
CASTANEDA .Neonatal Clamps	455
Rib Spreaders	418
CASTROVIEJO .Calipers and Markers	483
Capsular Forceps	498
Cyclodialysis Spatulas	474,485
Eye Knives	466
Eye Spatulas	474-475,485
Eye Speculas	462
Fixation Forceps	502-503
Iridectomy Scissors	67,69
Keratomes	466
Lachrymal Dilators	484
Micro Needle Holders	216-217,226
Micro Needle Holders TC	226,227
Razor Blade Breakers	30
Suture Forceps	502
CASTROVIEJO-BARRAQUER .Eye Spatulas	474
CASTROVIEJO-KALT .Micro Needle Holders	225
Cataract Knives	464
Spoons	475
Catheter.Forceps	14
Introducing Instruments	14
CATLIN ,Amputation Knives	27
Cephalotomy Scissors	50
Cervical,Biopsy and Specimen Forceps	395-398
Traction Tongs	507
CHADWICK .Eye Scissors	83
Gum Scissors	94
Chalazion .Curettes	476
Curettes Double	477
Forceps	500
CHANDLER .Bone Levers	289
Iris Forceps	496
CHAPUT .Hemostatic Forceps	115
CHARRIERE .Amputation Saws	310
CHEATLE .Sterilizing Forceps	632
Cheek Retractors	182
CHERON , Cotton Swab Forceps	147

	Pages #		Pages #
COPPER .Ligature Needles	248	DAVIDSON-ALEXANDER .Periosteal Raspatories	275
CORDES Tips	629	DAVIEL .Cataract Spoons	475
CORWIN .Tonsil Hemstatic Forceps	625	DAVIS , Dissectors	517
Corneal, Dissectors	477	Foreign Body Needles	470
Fixation Forceps	501	DAVIS-BOYLE .Mouth Gags	615
Knives	468	DAY , Hooks	586
Scarifiers	468	DE-BAKEY ,Aortic Aneurysm Clamps	431
Coronary Scissors	55	Aortic Clamps	435
Cortex Aspirating Canuulas	480	Atrauma Bulldog Clamps	424
CORYLLOS .Retractors	177	Atrauma Cardiovascular Forceps	429,439,447
COS ,Micro Forceps	573	Atrauma Tissue Forceps	422-423
COTTLE .Alar Protectors	610	Carotid Clamps Forceps	426
Chisels	603-604	Dissecting and Ligature Forceps	428
Columella Forceps	610	Ligature Clamps	435
Mallets	320	Multi Purpose Clamps	441,445
Nasal Rasps	608	Needle Holders	236
Nasal Scissors	63	Peripheral Clamps	439
Nasal Speculas	592	Retractors	201
Rhinoplastic Hooks	609-610	Rib Spreaders	416
Rhino Knives	600	Vascular Forceps	428-431,435-439,441,447
Scissors, SuperCut	37	Vascular Scissors	55,58
Septum Elevators	601-602	DE-BAKEY-BAHNSON ,Aorta Aneurysm Clamps	443
COTTLE-NEIVERT .Rhinoplastic Hooks	609	DE-BAKEY-BAINBRIDGE ,Atrauma Cardiovascular Forceps	429
COTTLE-WALSHAM .Septum Straightening Forceps	611	DE-BAKEY-BECK ,Atrauma Cardiovascular Forceps	439
Cotton,Applicators	211-213	DE-BAKEY-CAROTID , Clamp Forceps	426
Swab Forceps	145,147-148	DE-BAKEY-FINE ,Needle Holders TC	236
Cover Glass Forceps	110	DE-BAKEY- MOSQUITIO .Atruma Hemostatic Forceps	444
Gauze.Packers	620	DE-BAKEY-PEAN ,Atrauma Hemostatic Forceps	444
CRAFOORD .Hemostatic Forceps	127	DE-BAKEY-RANKIN ,Atrauma Hemostatic Forceps	45
Lobectomy Scissors	61	DE-BAKEY-SATINSKY ,Bulldog Clamps	425-426
CRAIG .Septum Forceps	594	DE-BAKEY-SEMB .Ligature Clamps	436
CRAIG-DOMNICK .Septum Forceps	594	DE LEE .Obstetrical Forceps	410
Cranioclasts	408	Pelvimeters	405
CRAWFORD .Retactors	172	DE VILLBISS .Cranial Forceps	506
CRILE ,Hemostatic Forceps	119	DEAN .Eye Knives	468
Needle Holders	233	Gum Scissors	93
Retractors	150,157	DEAVER ,Retractors	178
CRILE-BABY .Hemostatic Forceps	119	Retractors Handles	178
CRILE-MURRAY .Needle Holders	233	Scissors	40
CRILE-RANKIN .Hemostatic Forceps	119	Decapitating Hooks	408
CRILE-WOOD .Needle Holders	232	DECKER .Micro Scissors	540
Needle Holders TC	237	DEJERINE .Percussion Hammers	2
CRITCHETT .Eye Speculas	462	DEMEL .Bone Wire Guides	319
Crown Scissors	91	DENHART .Mouth Gags	16
Crurotomy Forceps	576	DENIS-BROWN .Abdominal Retractors	08
CRUTCHFIELD .Bone Drills	507	DERF .Needle Holders	29
Cervical Traction Tongs	507	Needle Holders TC	235
CULLER .Iris Spatulas	473	Dermatology Instruments	328-329
Muscle Hooks	471	DERRA-DE BAKEY .Atrauma Cardiovascular Forceps	446
CUSCO .Vaginal Speculas	366	DESCHAMPS .Ligature Needles	244-246
CUSHING ,Brain Spatulas	520	DESJARDINS .Gall Duct and Cystic Forceps	355
Decompression Hooks	158	Gall Stone Forceps	356
Dressing Forceps	99	Gall Stone Probes	357
Laminectomy Rongeur Forceps	530-531	Gall Stone Scoops	358
Nerve Retractors	523	DESMARRES .Chalazion Forceps	500
Retractors	150,157-158	Corneal Knives	468
Tissue Forceps	104	Lid Retractors	463
CUSHING-LANDOLT .Speculas	563	Retracotrs	157
CUSHING-KOCHER .Retractors	158	DIEFFENBACH ,Bulldog Clamps	115
CUSHING-TAYLOR .Dressing Forceps	99	Operating Knives	24-25
Cyclodialyse,Spatulas	473-474	DIETER .Micro Forceps	573
Spoons	485	DIETRICH .Aortic Clamps	432
Cystotome Cannulas	475	Bulldog Clamps	149
Cystotomes	470	Micro Needle Holders TC	228
CZERNY .Gall Stone Forceps Forceps	356	Dilating Bougies	363
Rectal Speculas	344	DINGMAN .Bone Holding Forceps	292
Tenaculum	386	Raspatories	187
		Retractors	186
		Wire Guides	186
		DINGMANN ,Mouth Gags	615
		Directors,With Tongue Tie	210
		With Probes	210
		Discission Needles	469
		Dissecting and Ligature Forceps	124,128-134
		Dissecting, Knives	22
		Scissors	43-48,55,60,64,84
		Dissecting Sets	33
		Dissectors	517-519,552-553
		DITTAL .Dilating Bougies	363
		DIX ,Double-Ended Instruments	485

D

DAHLGREN .Cranial Forceps	506
DANDY ,Hemostatic Forceps	122
Nerve Retractors	524
Scissors	64,84
DARDIK .Atrauma Cardiovascular Forceps	440
DARTIGUES ,Uterine Elevating Forceps	389
DASTOOR .Erisiphakes	499
DAUBENSPECK .Bone Currettes	269
DAVIDSON .Retractors	181

	Pages #		Pages #
Foreign Body Instruments	470	Episiotomy.Scissors	62
DIXON-LOVELACE. Hemostatic Forceps	123	EPPENDORF. Cervical Biopsy and Specimen Forceps	395
DOCKHORN. Cheek Retractors	182	EPSTEIN. Bone Curettes	272
Double Ended Instruments	485-486	ERHARDT. Ear Speculas	564
DOUAY. Cervical Biopsy and Specimen Forceps	395	Entropium Forceps	491
DOUGLAS. Cilia Forceps	110	Erisiphakes	499
Tonsil Knives	621	ERMOLD. Needle Holders	232
Trocars	8	ESMARCH. Bandage Scissors	88
DOYEN. Abdominal Retractors	209	Plaster Knives	256
Gynaecological Scissors	50	Eustachin Catheters	568
Intestinal Clamp Forceps	333	EVES. Tonsil Snare	624
Myoma Screws	390	EWALD. Dressing Forceps	96
Ovarian Forceps	389	Tissue Forceps	102
Periosteal Raspatories	278	Exenteration Scoops	477
Retractors	175	Extension Bows	317-318
Towel Forceps	143	Extirpation Chisels	470
Vaginal Speculas	375-376	Eye,Cannulas	478-482
DOYEN-ATRAUMA. Intestinal Clamp Forceps	334	Extraction Hooks	471-472
DOYEN-STILLE. Retractors	175	Hooks	471-472
Dressing Forceps	95-99	Instruments	458-505
Drill Guide and Dura Protecting Forceps	312	Knives	464-466,469
DUAL. Stethoscopes	1	Knives Lanced Form	467
DUBOIS. Gynecological Scissors	50	Ligature Needles	505
DUNCAN. Biopsy Curettes	392	Muscule Hooks	473
DUPLAY. Polypus and Dressing Forceps	146	Protectors	473
Tenaculum Forceps	385	Scalpels	464
DUPUY-WEISS. Ligature Needles	247	Scissors	80-82
Dura,Dissectors	517-519	Spatulas	474
Elevators	517-519	Speculas	459-462
Scissors	84		
DURANTE. Tissue Forceps	105	F	
DURHAM. Ligature Needles	247	FAHLBUSCH. Curettes	562
DUVAL. Intestinal Tissue Forceps	332	Pituitary Instruments	562
Tissue Forceps	105	FALK. Jonsil Needles	620
Dynamometers	5	FARABEUF. Bone Holding Forceps	296
		Periosteal Raspatories	279
		Retractors	161
		FARABEUF-COLLIN. Periosteal Raspatories	274
		FARABEUF-LAMBOTTE. Bone Holding Forceps	297
		FARREL. Cotton Applicators	212
		FAULKNER. Curettes	612
		FAURE. Cervical Biopsy and Specimen Forceps	394
		Clamp Forceps	139
		Hysterectomy Forceps	141
		FAVALORO. Vascular Scissors	55
		FRAGER. Dissectors	518
		FEHLAND. Intestinal Clamp Forceps	336
		FEILCHENFELD. Splinter Forceps	108
		FEIN. Cotton Applicators	211
		FERGUSSON. Bone Holding Forceps	293
		Gall Stone Scoops	359
		Haemorrhoidal Clamps	136
		Uterine Scissors	42
		Suction Tubes	9
		FERGUSSON-ACKLAND. Mouth Gags	617
		FERRIS-SMITH. Rongeurs	532
		Septum Forceps	595
		Tissue Forceps	105
		FERRIS-SMITH-KERRISON. Antrum Punch	598
		Rongeurs	526-527
		Fine,Forceps	107
		Operating Scissors	51-54
		Scissors	51-54
		Scissors. SuperCut	35
		Finger.Goniometers	5
		Protectors	619
		Ring Cutters	309
		FINK. Eye Hooks	472
		FINOCCHIETTO. Gall Duct Clamps	133
		Lobectomy Scissors	61
		Needle Holders	231
		Needle Holders TC	239
		Rib Spreaders	413,419
		FINOCCHIETTO-BABY. Rib Spreaders	413
		FINOCCHIETTO-BABY-HAIGHT. Rib Spreaders	418
		FINOCCHIETTO.BURFORD. Rib Spreader	413
		FINSEN. Retractors	190
		FINSTERER. Suction and Irrigation Cannulas	12

E

Ear.Cannulas	15
Catheters	568
Curettes	585
Dressing Forecp	111
Knives	578,586-587
Loops	585
Polypus Forceps	570-571
Polypus Snare	569
Punches	584
Speculas	564-566
Spoons	585
Syringes	588
EASTMAN. Vaginal Speculas	371
ECHLIN. Bone Rongeur Forceps	306
EICKEN-KILLIAN. Wash Cannulas	614
EISELSBERG. Ligature Scissors	86
Elevating Spoons	407
Elevators	282-283
ELLIOT. Obstetrical Forceps	411
ELLIS. Foreign Body Gouges	470
ELSAESSER. Nephrostomy Forceps	354
ELSCHNIG. Capsular Forceps	497-498
Corneal Knives	468
Eye Spatulas	474
Tissue Forceps	506
EMMET. Fistula Hooks	390
Fistula Hooks Laser	384
Polypus Forceps	147
Endarterectomy Scissors. SuperCut	36
Endarterectomy Strippers	215
Endolaryngeal Micro Surgery Instruments	626-627
Endospecula	368,381
ENGEL. Plaster Saws	256
ENGLISH PATTERN. Dressing Forceps	95
Towel Forceps	142
Enterotomy Scissors	61
Entropium Forceps	491
Enucleation.Scissors	52
Scoops	476
Epiglottis Retractors	631

	Pages #		Pages #
FISCH. Crurotomy Forceps	576	Tubing	144
Micro Dissectors	581	Twin Clamps	341,343
FISCHER. Iris Forceps	496	Vaginal	138-139
Tonsil Knives	621	Watchmarkers	106,504
Tendon Strippers	322	FORD, Stethoscopes	1
FISCHER-ARIT. Iris Forceps	496	FORD-DIXON, Haemorrhidal Ligators	351
FISH. Probes	210	Foreign,Body Chisels	470
Fistula,Hooks	390	Body Curettes	476-477
Knives	26	Body Lever Instruments	586
Probes	211	Body Forceps	365
Scissors	50	Body Gouges	485-486
Fixation,Discs For Extension Bows	318	Needles	485-486
Discs for Wires Drills	318	FOREGGER. Laryngoscopes	18
Forceps	496-497	FORSTER. Swab Holding Forceps	148
Forks	469	FOX. Lupus Curettes	329
Flap,Knives	27	FRAENKEL. Laryngeal Polypus Forceps	631
FLATAU. Tips	629	Nasal Speculas	589
FOERSTER. Iris Forceps	494	Tips	629
Sponge Holding Forceps	148	Tongue Deressors	618
FOMON. Chisels	604	FRANCIS, Foreign Body Needles	469
Nasal Rasps TC	606-607	FRANKFELDT. Cotton Applicators	213
Nasal Scissors	63	FRANZ, Abdominal Retractors	209
Nasal Scissors,SuperCut	37	FRAZIER. Abdominal Retractors	202
Retractors	610	Elevators	517
Rhinoplastic Hooks	609-610	Hooks	609
Forceps,Advancements	490-491	Nerve Retractors	525
Anastomosis Clamps	428,438,442,446	Retractors	150
Aneurysm Clamps	430-431,443	Suction Tubes	9-10
Anterior Chamber	492	FREER. Chisels	603
Aortic	432,453-456	Rhinoplastic Hooks	609
Atrauma	111-423	Rhinoplastic Knives	600
Auricle	433	Septum Elevators	601
Blindgut	339	FREER-YASARGIL. Septum Elevators	601
Bloodvessel	421-422	FRIEDMANN, Bone Rongeur Forceps	299
Bronchus	127,421	FRIEDMANN-DELICATE. Bone Rongeur Forceps	300
Bulldog	115,149	FRITSCH. Retractors	175
Capsular	496-498	FRYKHOLM. Bone Rongeur Forceps	306
Cardiovascular	421-455	FUCHS. Capsular Forceps	498
Chalazion	500	Iris Forceps	496
Cilia	109-110	FUCHSIG. Hemostatic Forceps	123
Clip Applying	255		
Coarctation	443,449	G	
Conjunctival	495	Gall,Duct and Cystic Forceps	355
Cover Glass	110	Duct Clamp Forceps	133-134,137
Dissecting and Ligature	124,128,134	Duct Duct Forceps	355
Dressing	95-99	Duct Stone Forceps	356
Ear	111,569-576	Duct Stone Probes	357
Entropium	491	Duct Stone Scoops	358-359
Fine	107	GARLAND. Mallet	321
Fixation	496-497	GARLAND. Clamp Forceps	137
Gall Duct and Cystic	355	GAUSS. Scalp Flap Forceps	07
Haemorrhoidal	115,136	Gauze Packers	20
Hemostatic	115-127	GELLHORN. Cervical Biopsy and Specimen Forceps	93
Hysterectomy	135-138	GELPI. Abdominal Retractors	00
Intestinal Clamps	335-337,339	GEMINI, Dissecting and Ligature Forceps	131
Iris	492-497	GERALD, Dressing Forceps	98
Kidney Pedicle Clamps	352-353	Tissue Forceps	104
Ligature	109,435,-436	GERBORE. Aortic Dilators	57
Multipurpose	441,446	GERZOG. Mallets	321
Muscle	327,490-491	GERZOG-SEXTON, Knives	586
Nail Tearing out Toe and Finger Nails	309	GIERTZ-STILLE. Rib Shears	12
Nasal	593-594	Gigli,Saws	506
Neonatal	454-455	Saws Handles	506
Parametrium	135	GIL-VERNET, Retractors	154
Penis	365	GILL. Corneal Knives	468
Pressure	137	Iris Forceps	496
Profunda	446	GILL-ARRUGA, Capsular Forceps	497
Scalp Flap	138	GILL-HESS, Iris Forceps	496
Sinus	145	GILLIES. Cutaneous Hooks	150,329
Splinter	107-108	Needle Holders	233
Sterilizing	632	Needle Holders with Scissors TC	243
Stomach Clamps	340-341,343	Retractors	150
Strabismus	489-490	Tissue Forceps	103
Suture	488-489	GILLIES-SLIM. Needle Holders	243
Tangential Occlusion	437	GILLS-WELSH, Irrigation and Aspiration Cannulas	479
Tendon	322-324	GLOVER. Anastomosis Clamps	428,437,442
Tissue	100-106,502	Atrauma Bulldog Clamps	425
Towel	142-143	GOELET. Retractors	160
Trachoma	500		

	Pages #		Pages #
Goitre, Grasping Forceps	327	HALSEY , Needle Holders	229
Instruments	327	HALSTEAD-MOSQUITO , Hemostatic Forceps	117-118
Probes	327	HAMBURG , Eye Knives Lanced Form	467
GLUCK , Rib Shears	90	HAMILTON-BAILY , Irrigating Cannulas	15
GOLDMAN-FOX , Gum Scissors	64, 92	HANK , Uterine Dilators	380
GOLDSTEIN , Eye Speculas	460	HARDY , Dissectors	552
Goniometers	5	Pituitary Curettes	560
Goniotomy Knives	469	HARDY-FAHLBUSCH , Dissectors	552
GOOD , Tonsil Scissors	61	HARM , Lachrymal Probes	484
GOODELL , Uterine Dilators	381	HARKEN , Auricle Clamps	433
GOSSET , Abdominal Retractors	201-202	Blood Vessel Clamps	422
Gouges	258-264, 603	HARRINGTON , Retractors	178
GOURDET , Uterine Curettes	399	HARRINGTON-BABY , Retractors	178
GRADLE , Cilia Forceps	109	HARRINGTON-PEMBERTON , Retractors	178
GRAEFE , Cataract Knives	468	HARTMANN , Bone Rongeur Forceps	300
Cataract Spoons	475	Ear Catheters	568
Corneal Scarifiers	473	Ear Hooks	586
Cystotomes	470	Ear Polypus Forceps	570-571
Eye Scissors	83	Ear Speculas	564-566
Eye Speculas	461	Hemostatic Forceps	117
Fixation Forceps	502	Nasal Cutting Forceps	596
Iris Forceps	494-495	Nasal Polypus Forceps	594
Iris Hooks	471	Nasal Speculas	589-592
Iris Knives	464	Tongue Depressors	618
Lens Hooks	475	Tonsil Punch Forceps	625
Skin Hooks	151	Tuning Forks	567-568
Strabismus Hooks	473	Wash Cannulas	614
GRAEFE-ARRUGA , Cataract Knives	464	HARTMANN-CITELLI , Ear Polypus Forceps	571
GRAETHER , Collar Botton Cannulas	482	HARTMANN-HALLE , Nasal Speculas	590
GRAHAM , Nerve Retractors	525	HARTMANN-NOYES , Ear Polypus Forceps	571
Grasping Forceps	105-106, 112, 534	HARTMANN-WEINGARTNER , Ear Polypus Forceps	571
GRAVE , Vaginal Speculas	367-368	HARTMANN-WULLSTEIN , Ear Polypus Forceps	571
Vaginal Speculas For Laser Surgery	368	HARVEY , Wire Cutting Scissors	87
GRAY , Gall Duct Forceps	355	HASLINGER , Uvula Retractors	622
GRAZIL , Operating Scissors	40	HAYES , Atrauma Sidmiod Anastomosis Forceps	336
GREEN , Corneal Dissectors	470	Head Extractors	407
Double Spatulas	485	Head Lamps	4
Eye Muscle Hooks	471	HEANEY , Hysterectomy Forceps	135
Fixation Forceps	504	Needle Holders	230
Retractors	172	Retractors	179
GREEN-ARMYTAGE , Uterine Haemostasis Forceps	406	Uterine Curettes	400
GREENE , Uterine Curettes	400	HEANEY-BALLENTINE , Hysterectomy Forceps	136
GREGORY , Profunda Clamps	446	HEANEY-SLIM , Hysterectomy Forceps	135
GREGORY-SOFT , Bulldog Clamps	426	HEATH , Ligature Scissors	86
GREVEN , Ear Polypus Forceps	573	Mallets	320
GROSS , Foreign Body Instruments	586	HEBRA , Chalazion Curettes	476
GROSS-MAIER , Polypus and Dressing Forceps	146	Comedone Extractors	328
GRUBER , Ear Speculas	565	HEGAR , Needle Holders	230
GRUENWALD , Dressing Forceps	99	Uterine Dilators	379
Nasal Cutting Forceps	596	HEGAR-BAUMGARTNER , Needle Holders	229
GRUENWALD (JANSEN) , Nasal Dressing Forceps	593	Needle Holder TC	236
GUEDEL-NEGUS , Laryngoscopes	19	HEGAR-VASCULAR , Needle Holders	238
Gum Scissors	64, 92-94	HEGEMANN , Vascular Scissors	58
GUTHRIE , Double Fixation Hooks	472	HEGENBARTH , Clip Applying Forceps	255
Skin Hooks	151	HEIFETZ , Brain Spatulas	520
GUTTMANN , Secretion Scoops	365	HEISS , Dissecting and Ligature Forceps	130
GUYON , Catheter Introducing Instruments	364	HEISTER , Mouth Gags	617
Atrauma Kidney Pedicle Clamp	352	HELFERRICH-BIER , Amputation Saws	310
Forceps	352	Hemilaminectomy Retractors	197
Kidney Pedicle Clamps Forceps	352-353	Hemostatic Forceps	115-127
GUYON-LUNDSGAARD , Sclerotomes	469	HENLEY , Retractors	193
Gynecological Instruments	364-404	Dissectomy Retractors	516
Gynecological Scissors	49-50	HENKE , Tonsil Elevators	622
		HENNER (LEMPERT) , Retractors	192
		HENNING , Plaster Spreaders	256
		HENRY , Cilia Forceps	109
		HEPP-SCHIEDEL , Micro Needle Holders TC	227
HABERER , Abdominal and Intestinal Spatulas	180	HERRICK , Kidney Pedicle Clamp Forceps	353
Intestinal and Stomach Clamps Forceps	343	HERTZLER , Retractors	202
Haemorrhoidal, Clamps	115, 136	HESS , Capsular Forceps	497
Forceps	349-351	Iris Forceps	492
Ligators	350-351	Lens Expressors	475
HAGLUND-STILLE , Plaster Spreaders	256	HEY , Dissectomy Retractors	514
HAIGHT , Rib Spreaders	415	HEY-GROVES , Bone Holding Forceps	294
HAJEK , Mallets	320	HEYMANN , Nasal Scissors	63
Nasal Cutting Forceps	596	Nasal Scissors, SuperCut	37
HAJEK-KOFLER , Laminectomy Rongeurs	537	Polypus Forceps	594
Septum Forceps	597-598	HEYWOOD-SMITH , Bone Heamorrhoidal Forceps	349
HALLE , Bone Curettes	270	Uterus Polypus Forceps	388
Nasal Scissors	63		
Septum Elevators	601		

H

	Pages #
HIBBS .Bone Chisels	263
Gouges	263
Osteotomes	263
Retractors	179
HIRSCHMANN .Anusscopes	345
Eye Spatulas	474
Iris Hooks	471
HOEN .Elevators	282,517
Nerve Retractors	524
HOFFER .Tonsil Retractors	622
HOFFER .Marking Instruments	487
HOFFMANN .Tubing Forceps	144
HOHMANN .Bone Levers	285-286
HOHMANN-ALDINGER .Bone Levers	287
HOKE .Osteotomes	260
HOLSHER .Nerve Root Retractors	522
HOLZBACH .Hysterectomy Forceps	137
HOLZHEIMER .Retractors	191
Hooks.Autopsy	31
Handles	506
Wood and Nerve	150-151
HOPKIN .Plaster Knives	256
HORSLEY .Elevators	519
Hose Connecting Pieces	401
HOSEL .Needle Holders TC	242
Retractors	170
HOSOBUCHI .Spatulas	561
HOUGH .Micro Forceps	573
HOUSE .Micro Hooks	581
Micro Spoons	582
Suction Tubes	568
HOWARTH .Septum Elevators	601
HUBER .Universal Handles	628
HUDSON .Bone hand Drills	311
Conical and Spherical Burrs	311
HUMBY .Retractors	153
HUNTER .Splinter Forceps	108
HURD .Tonsil Elevators	622
Tonsil Needles	620
HYLIN .Periosteal Raspatories	277
Hysterectomy Forceps	135-138

I

Incision Scissors	42
INGE .Lamina Spreaders	513
Inhalers	14
Instrumentation For D.B.Kirby	486
Instruments For Brain Suture	508
For Cranial Opening	506
For Radial Keratotomy	487
Interchangeable Tips	629
Interosseous Knives	27
Intervertebral Disc Rongeur	526-529
Intestinal and Stomach Clamps	340-341,343
and StomachTwin Clamp Forceps	341-343
Clamp Forceps	335-337,339
Tissue Forceps	330-331
IOWA .Pelvimeters	405
Tenaculum Forceps	388
Iridectomy Scissors	65-69
Iris,Forceps	492-497
Hooks	471
Knives	468
Scissors	53
Scissors SuperCut	35
Spatulas	473-474,485
Irrigating,Cannulas	478
Vectis Cannulas	479
Aspiration Cannulas	479
ISRAEL .Retractors	166
ITARD .Ear Catheters	568
ITERSON .Wound Retractors	156
IVES-FANSLER .Anusscopes	346

J

JACKSON .Wound Retractors	153,156
----------------------------------	---------

	Pages #
Vaginal Speculas	370
JACOBI .Eye Ligature Needles	505
JACOBS .Tenaculum Forceps	388
JACOBSON .Bone Curettes	271
Mirco Needle Holders	217
Micro Needle Holders TC	228
Micro Probes	544
Micro Scissors	73
Micro Suture Pusher and Knot Tiers	544
Micro Vessel Knives	541
Micro Vessel Probes	544
JACOBSON-ADSON .Dressing Forceps	96
Hemostatic Forceps	124
JACOBSON-HALSTEAD .Hemosatic Forceps	117
JAEFE .Eye Speculas	474
JAEGER .Eye Hooks	471
Keratomes	465
Lid Plates	463
JAEGER-GRIESHABER .Keratomes	465
JAMESON .Needle Holders	231
Scissors	52
Scissors,SuperCut	35
Strabismus Forceps	490
Strabismus Hooks	471
JANNETTA .Micro Dissectors,Elevators	546
Micro Surgery Instruments	546
JANSEN .Bone Curettes	271
Bone Rongeur Forceps	301-302
Capsular Polishing Cannulas	480
Dressing Forceps	569
Ear Forceps	111
Head Lamps	4
Nasal Forceps	111
Periosteal Raspatories	275
Retractors	191
Spoons	585
Tissue Forceps	111
JANSEN-DEEP .Retractors	191
JANSEN (GRUENWALD) Ear Forceps	111
Nasal Forceps	111,593
JAVID .Carotid Clamps	448
JEFFE-KNOLLE .Iris Hooks	471
JENNING .Mouth Gags	617
JOBSEN-HORNE .Cotton Applicators	212
JOHNS-HOPKINS .Applying Forceps	115
Bulldog Clamps	115
Dissecting and Ligature Forceps	128
JONES .Jewel Forceps	142
JOSEPH .Nasal Rasps	608
Nasal Saws	605
Periosteal Elevators	601
Raspatories	602
Rhinoplastic Hooks	609
Rhinoplastic Knives	599
Scissors	54
Septum Elevators	601
JOSEPH-COTTLE .Septum Forceps Elevators	602
JUDD-ALLIS .Intestinal Tissue Forceps	331
JUDD-MASSON .Bladder Retractors	361-362
JUERS .Micro Forceps	573
JURASZ .Adeniod Cutting Forceps	599
Laryngeal Polypus Forceps	631

K

KADER .Abdominal and Intestinal Spatulas	180
KALLMORGEN .Vaginal Speculas	374
KALT .Capsular Forceps	498
Micro Needle Holders	225
Micro Needle Holders TC	227
KALT_ARRUGA .Micro Needle Holders	225
KANTROWITZ .Hemostatic Forceps	127
KATSCH .Comedone Extractors	328
KATZIN .Iridectomy Scissors	68
KATZIN-BARRAQUER .Iridectomy Scissors	68
KAZANIJIAN .Bone Cutting Forceps	308
Septum Forceps	597
KELLY .Fistula Scissors	50

INDEX

	Pages #		Pages #
Hemostatic Forceps	118,126	KNOWLES .Bandage Scissors	89
Proctoscopes	346	KOCHER .Bladder Reteractors	362
Retractors	173-174,176	Bulb Headed Probes	327
Sphincteroscopes	346	Goitre Directors	327
KELLY-RANKIN ,Hemostaic Forcpes	118	Hemostatic Forceps	121
KELSEY-FRY ,Awls	189	Intestinal Clamps Forceps	337
Keratomes	465-466	Ligature Needles	247
KERN ,Bone Holding Forceps	294	Retractors	164,169-170,175
KERRISON ,Antrum Rongeurs	584	KOCHER-ATRAUMA ,Intestinal Clamp	337
KEVORKIAN .Biopsy Curettes	392	Forceps	169
Cervical Biopsy and Specimen Forceps	395,398	KOCHER-LANGENBECK .Retractors	169
KEY .Elevators	283	KOCHER-WAGNER .Retractors	170
KIDNEY .Pedicel Clamp and Forceps	352-353	KOENIG .Elevators	254
Stone Forceps	354	Ligature Conductors	276
KIELLAND .Obstetrical Forceps	410	Periosteal Raspatories	157
KIELLAND-LUIKART .Ostetrical Forceps	410	Retractors	157
KILLIAN .Gouges	603	KOERTE .Retractors	166-67
Laryngeal Polypus Forceps	631	KOERTE-WANGER .Retractors	167
Nasal Speculas	591	KOGAN .Endospeculas	381
Septum Elevators	502	KOGAN-LASER .Endospeculas	368
Wash Cannulas	614	KOLLE .Iris Hooks	471
KILLIAN-CLAUS .Gouges	602	KNOLLE-KELMANN .Cystotome Cannulas	479
KILNER .Needle Holders TC	237	KNOLLE-PEARCE ,Irrigating Vectis Cannulas	480
Retractors	150	KOOS .Micro Vessel Knives	541
Rhinoplastic Hooks	610	KRATZ .Capsule Polishing Cannulas	470
Scissors	55	Cystotome Cannulas	479
Skin Hook	329	KRAUSE .Ear polypus Snares	593
KILNER-DOUGHTY .Mouth Gags	615	Nasal Snares	629
KIRBY .Capsular Forceps	486	Trocars	8
Fixation Forceps	486	KRAUSE-VOSS .Ear Ploypus Forceps	569,593
KIRCH .Cheek Retractors	182	Nasal Snares	593
KIRSCHNER .Abodominal Retractors	207	KRAYENBUL .Ligature Guides	543
Extension Bows	317	KREMER .Corneal Fixation Forceps	501
Ligature Conductors	253	KRESSNER .Septum Punch Forceps	611
Traction Hooks For Extension Bows	318	KRISTELLER .Vaginal Speculas	371-373
Wire Strainers For Extension Bows	318	KROENIG .Tongue Depressors	618
KLAPP .Tendon Sheath Hooks	158	KROENLEIN ,Hemostatic Forceps	122
KLEINERT-KUTZ .Bone Rongeur Forceps	303	KRONECKER .Ligature Needles	247
Retractors	153	KUEHNE .Cover Glass Forceps	110
Tendon Passing Forceps	323	KUEMMEL .Retractors	179
KLEINSCHMIDT .Blindgut Forceps	339	KUHNT .Corneal Scarifiers	468
KLINGENBERG-LOTH .Vascular Scissors	57	KWITKO .Eye Spatulas	474
KNAPP .Cataract Spoons	475		
Discission Knives	467	L	
Eye Hooks	472	LA BORDE .Trachea Dilators	325
Scissors	54	Lachrymal,Cannulas	481
Trachoma Forceps	472,500	Dilators	483-484
KNAPP-CLARK .Eye Speculas	461	Probes	484
KNAPP-ROLLET .Eye Hooks	472	Sac Dissectors	477
KNIGHT -Nasal Scissors	63	Sac Hooks	470
Knives.Amputation	27	LA FORCE .Foreign Body Instruments	470
Autopsy	28-29,31	Adenotome	613
Brain	28	LA GRANGE .Eye Scissors	83
Capsulotomy	468	Gum Scissors	93
Cartilage	29	LAHEY .Gall Duct Clamps	134
Cataract	464	Goitre Grasping Forceps	327
Cone	390	Retractors	168
Corneal	468	LAMBERT .Chalazion Forceps	500
Discission	467	LAMBERT-KAY .Aortic Anastomosis Clamps	438
Eye	464-468	LAMBOTTE .Bone Holding Forceps	296-297
Fistula	26	Bone Osteotomes	261
Flap	27	Periosteal Raspatories	282
Goniotomy	468	Lamina Spreaders	509-513
Interosseous	27	Laminectomy Reongeurs	530-534,536-537
Iris	468	LANCASTER .Eye Speculas	461
Meniscotomy	291	LANDAU ,Irocars	7
Moncorps	329	Vaginal Speculas	377
Myoma	390	LANDOLT .Enucleation Scissors	52
Nerve Knives	525	Pituitary Rongeurs	535
Phalangeal	27	Scissors	52
Plaster	256	LANDOLT-REULEN ,Dissectors	562
Post Mortem	28	Hooks	562
Pterygium	469	LANE ,Bone Holding Forceps	297
Ptosis	469	Bone Levers	288
Resection	28	Stomach Clamps	341
KNOLLE ,Iris Hooks	471	Tissue Forceps	105
KNOLLE-KELMANN .Cystotome Cannulas	479	Towel Forceps	143
KNOLLE-PEARCE ,Irrigating Vectis Cannulas	480	LANE-TRETHOWAN , Bone Levers	288
Knot Tiers	254		

INDEX

	Page #		Page #
MASS.-GENERAL HOSPITAL. Elevators	282	MICHEL. Clip Applying Forceps	255
Needle Holders	231	Laryngeal Mirrors	630
MASSON. Needle Holders	231	Micro,Curettes	554-555
Needle Holders TC	239	Dissectors	542-547,552,556-559
MASTIN, Muscle Forceps	327	Ear Polypus Forceps	572-576
MATHIEU, Foreign Body Forceps	365	Elevators	542
Needle Holders	234	Forceps	572-576
Needle Holders TC	240,242	Hooks	546,547,550,556
Rectal Speculas	344	Instruments	538-563,572-583
Retractors	161	Instruments with Finger Grip	543
Vaginal Speculas	375	Knives	548
MATHIEU-KOCHER, Needle Holders TC	241	Laryngeal Cup Forceps	626
MATHIEU-RYDER, Needle Holders TC	240	Laryngeal Forceps	626
MATSON, Periosteal Raspatories	277	Laryngo Scissors	626
MATZENAUER. Vaginal Speculas	375	Ligature Needles	547,549,551
MAYFIELD, Bone Rongeur Forceps	303	Measuring Rod	581
MAYO, Gall Stone Scoops	359	Mobilizers	581
Grasping Forceps	105	Needles	579-580
Tongue Depressors	618	Needle Holders	216-226
Scissors	43	Needle Holders TC	226
Scissors. SuperCut	34	Nerve Hooks	543-545-547,550-551,556
Scissors. TC	43	Raspatories	549,553,556
Sterilizing Clamps	632	Scissors	70-79,573-575,577
MAYO-ADAMS, Abdominal Retractors	199	Scoops	556
MAYO-BLAKE, Gall Stone Forceps	356	Vessel Dilators	544
MAYO-COLLIN, Retractors	161	Vessel Knives	541
MAYO-GUYON, Kidney Pedicle Clamp,Forceps	353	MICRO-ADSON, Dressing Forceps	96
MAYO-HEGAR, Needle Holders	230	Tissue Forceps	102
Needle Holders TC	236	MICRO-MOSQUITO, Hemostatic Forceps	117
MAYO-NOBLE, Scissors	44	Microscopic.Instruments	32
MAYO-ROBSON, Atrauma Intestinal Clamp,Forceps	335	Needle Holders	32
MAYO-STILLE, Scissors	43	Needles	32
Scissors. SuperCut	34	Scissors	84
Scissors. TC	43	MIDDELDORPF, Retractors	172
McCULLOUGH, Strabismus Forceps	489	MIDDLETON-JANSEN, Septum Forceps	597
McDONALD, Elevators	283	MIKULICZ, Intestinal Clamp Forceps	140-141
McGANNEN, Iris Hooks	471	Peritoneal Clamp Forceps	140-141
McGEE, Micro Hooks	580	Retractors	176
Wire Closure Forceps	576	MILAN, Uterine Curettes	401
McGEE-FISCH, Wire Closure Forceps	576	MILLER, Bone Rasps	607
McGIVEN, Haemorrhoidal Forceps	351	Retractors	150
Haemorrhoidal Ligators	351	MILLER-BABY. Laryngoscopes	19
McINDOE, Bone Cutting Forceps	307	MILLES, Micro Scissors	75
Cartilage Scissors	57	MILLIGAN, Retractors	193
Dressing Forceps	96	Elevators	519
McINTOSH, Laryngoscopes	16	MILLIN, Bladder Retractors	361
McIVOR, Mouth Gags	615	Prostatic Lobe Holding Forceps	360
McLEAN, Obstetrical Forceps	410	Suction Tubes	13
McKENTY, Septum Elevators	601	MILLES, Mirco Scissors	75
McKENZIE, Applying Forceps	508	MILLS, Neurosurgical Scissors	84
McPHERSON, Suture Forceps	488	MINI-FRIEDMANN, Bone Rongeur Forceps	299
McQUIGG-MIXTER, Gall Duct Clamps	133	MINI-GEMINI, Dissecting and Ligature,Forceps	132
MEAD, Bone Rongeur Forceps	301	MINI-HOHMANN, Bone Levers	284
Mallets	321	MINI-LAMBOTTE, Bone Osteotomes	261
MEEKER, Dissecting and Ligature Forceps	31	MINI-LANGENBECK, Retractors	152
MELLINGER. Eye Speculas	460	MINI-LEXER, Bone Chisels	261
MELLINGER-AXENFELD. Eye Speculas	460	Bone Gouges	261
MELLINGER-BEARD, Eye Speculas	461	MINI-ROUX, Retractors	160
Meniscotomy Knives	291	MINI-TOWNSEND, Cervical Biopsy and Specimen Forceps	398
Meniscus,Knives	291	Mirror Handles	563
Retractors	290	Mirrors	563
MERCEDES, Thoracic Retractors	417	MITCHELL. Cannulas	15
MERSHON, Band Pushers	189	MIXTER, Dissecting and Ligature Forceps	132-133
Messer	578	Scissors	132
Metal Catheters	364	MIXTER-SHAUGHNESSY, Dissecting and Ligature Forceps	132
Handles For Laryngeal Mirrors	630	MIXTER-SLIM, Dissecting and Ligature Forceps	132
Support For Ear Speculas	566	MOD.USA. Umbilical Scissors	48,62
METZENBAUM, Dissecting Scissors	44-48	MOLTGEN, Goniometers	5
Dissecting Scissors TC	44-48	MOHR. Tubing Forceps	144
Scissors. SuperCut	34	MOLLISON, Retractors	192
METZENBAUM-FINE, Dissecting Scissors	44-48	MOLT, Mouth Gags	616
Scissors SuperCut	34	MOLT-BABY. Mouth Gags	616
MEYER. Foreign Body Gouges	470	MONCORPS. Knives	329
MEYER,SCHWICKERATH, Locators	471	MOORE. Gall Bladder Scoops	359
MEYERDING, Abdominal Retractors	200	MOOREFIELD, Suture Forceps	503
Retractors	156,179		
MEYHOEFER, Chalazion Curettes	476		

	Pages #		Pages #
MORITZ-SCHMIDT. Tongue Depressors	617	Needle Holders	229
MORRIS, Retractors	171	Needle Holders	235
MORRIS-DE-BAKEY, Aortic Anastomosis, Clamps	442	TC NEW SUTURE. Scissors	42
MORRIS-FAVALORO, Rib Spreaders	417	NICATI, Foreign Chisels	470
MOSQUITO, Atrauma Hemostatic Forceps	444	NICOLA. Pituitary Curettes	560
MOSQUITO-DANDY. Hemostatic Forceps	122	Pituitary Instruments	560-561
Mouth Gags	615-617	NIRO, Gum Scissors	92
MOYNIHAN. Gall Duct Clamps	137	NISSEN. Gall Duct Forceps	355
MUCK, Knives	586	Hemostatic Forceps	124
MUELLER. Eye Speculas	462	NORTHBENT. Ligature Scissors	85
MUENCHEN. Biopsy Curettes	391	NORWOOD. Rectal Snare	349
MULDOON. Eye Speculas	484	NOTO, Uterus Polypus Forceps	388
Multipose Clamps	441,446	NOTT. Vaginal Speculas	369
MURDOCK. Eye Speculas	464	NOVAK. Biopsy Curettes	391
MURLESS. Head Extractors	407	NOVAK-SCHOEKAERT. Biopsy Curettes	391
MURPHY, Retractors	165	NOYES. Iridectomy Scissors	65
MURPHY-LANE. Bone Levers	289	NUBOER. Suction Tubes	11
Muscle, Forceps	327	NUGENT, Strabismus Forceps	489
Hooks	490,491	NUSSBAUM, Intestinal Clamp Forceps	339
Retractors	31	Stomach Clamp Forceps	343
MUSEUX. Tenaculum Forceps	387		
Tonsil Seizing Forceps	623		
MYERS. Vein Strippers	214		
MYLES. Nasal Cutting Forceps	596		
Myoma, Knives	390		
Screws	390		
Myrtle Blade Probes	210		
N			
NABATOFF. Varicose Vein Probe Set	214	O'CONNOR. Conjunctival Forceps	495
NAGELE. Obstetrical Forceps	409	Iris Hooks	471
Perforators	407	Nerve Hooks	151
NAGER. Tonsil Elevators	622	O'SULLIVAN-O'CONNOR, Abdominal, Retractors	208
Tonsil Needles	620	Vaginal Speculas	378
Tonsil Retractors	622	Obstetrical Forceps	410-411
Nail, Instruments	309	Obstetrics Instruments	405-411
Nippers	633	OCHSNER, Aortic Clamps	432
Scissors	94	Ligature Forceps	109
Splitting Scissors	87	Trocars	8
Nasal, Cannulas	15	OCHSNER-KOCHER, Hemostatic Forceps	121
Curettes	612	OEHLER. Tissue Forceps	100
Cutting Forceps	596	OLDBURG, Nerve Root Retractors	523
Knives	599-600	Pituitary Rongeurs	535
Rasps	606-608	OLIVECRONA. Bone Rongeur Forceps	300
Saws	605	Brain Spatulas	520
Scissors	63	Dissectors	519
Snare	593	Elevators	519
Speculas	589-592	Trigeminal Scissors	64
Needle, Holders	229-234	Wire Saws	506
Holders TC	235-242	OLIVECRONA-TONNIS. Applying and Removing Forceps	508
Holders with Scissors	232-233	OLLIER. Retractors	165
Holders with Scissors TC	243	OLSEN-HEGAR. Needle Holders	232
Holders, Micro	216-226	Needle Holders TC	243
Micro TC	227-228	OKONOGTO. Ear Polypus Forceps	570
NEFF. Bone Holding Forceps	292	OMBREDANNE, Mallets	320
Meniscotomy Knives	291	Operating Knives	22-25,38-40
NEGUS. Adenoid Curettes	612	Operating Scissors	38-40,42-44
Artery Forceps	136	Operating Scissors, SuperCut	34
NEIVERT. Needle Holders TC	235	Operating Scissors, TC	38-39,43
NEIVERT-MASING. Rhinoplastic Hooks	609	Ophthalmology Instruments	459-505
NELATON, Probes	210	Oral Instruments	615-619
NELSON, Grasping Forceps	106	Orbit Spatulas	473
Trocars	8	Organ Grasping Forceps	332
Neontal Clamps	454-455	Otology Instruments Osteotomes	564-588
Nephrostomy Forceps	354	Osteotomes For Anatomy and Autopsy	258,260-263
Nerve and Vessels Hooks	543	Osteotomes For Maxillofacial Surgery	31
Dissecting Scissors	60	Ovarian Forceps	188
Hooks	551	OVERHOLT. Dissecting and Ligature Forceps	390
Retractors	522,525	Periosteal Raspatories	129
Root Retractors	521-523	OVERHOLT-GEISSEDOERFER,	277
NEUBUSER. Micro Scissors	98	Dissecting and Ligature Forceps	130
NEUMANN. Gum Scissors	93	OVERHOLT-MIXTER, Dissecting and Ligature Forceps	130
Neuro and Laminectomy Instruments	506-536	OVERHOLT-SLIM. Dissecting and Ligature Forceps	129
Neuro Surgical, Scissors	84		
NEVYAS. Cystotome Cannulas	479		
NEW ORLEANS. Lens Scoops	475		
		P	
		PACIFIC-KEVORKIAN. Cervical and Ligature Forceps	397
		PAPST. Round Keratome	466
		Parametrium, Forceps	135
		Scissors	62
		PARK. Anal Retractors	347

INDEX

	Pages #		Pages #
Eye Speculas	459	POOLE ,Suction Tubes	12
PARK-GUYTON ,Eye Speculas	459	Post Mortem Knives	28
PARK-MAUMENEE ,Eye Speculas	459	Post Mortem Needles	32
PARKER .Retractors	160	POTTS-De MARTEL .Neuro Surgical Scissors	84
PARKER-LANGENBECK (US-ARMY) ,Retractors	160	POTTS-SMITH ,Dressing Forceps	99
PARKER-MOTT .Retractors	161	Scissors.SuperCut	36
PARKES .Rasps TC	606	Vascular Scissors	55,57
PARTSCH .Bone Chisels	58	Vascular Scissors,TC	56
Bone Gouges	258	POZZI .Tenaculum Forceps	385
Mallets	21	PRATT .Fistula Probes	211
PASSOW .Bone Chisels	258	Haemorrhoidal Clamps	115
Levers	255	Rectal Speculas	344
Patella Forceps	298	Tenaculum Forceps	387
PATON ,Corneal Dissectors	468	Uterine Dilators	380
Micro Needle Holders	217	PRESTON ,Bone Holding Forceps	293
PATTERSON ,Cervical Biopsy and Specimen Forceps	394	PRICE-THOMAS ,Bronchus Clamps	421
PAUFIQUE .Suture Forceps	489	PRINCE .Muscle Hooks	490
PAUL .Eye Retractors	473	Tonsil Scissors	60
PAYR .Intestinal Clamps	340	Probes,	210,211
Ligature Conductors	51	Bulb Headed	210,211
PEAN .Hemostatic Forceps	116,121	Fistula	214
Trocars	7	For Varicose Veins	214
PEDERSON .Vaginal Speculas	369	Gall Duct	257
Pediatric Clamps Atrauma	454	Gall Stone	357
PEERS-BERTRAM .Towel Forceps	142	Goitre	327
PEET .Splinter Forceps	108	Micro	544
PELKMANN ,Polypus Forceps	146	Myrtle Blade	210
PELTESON ,Cotton Applicators	211	With Eye	210
Pelvimeters	405	Proctoscopes	346
PENFIELD .Elevators	517	Profunda Clamps	446
Penis Clamps	365	Prostatic.Lobe Holding Forceps	360
PENNINGTON .Hemsataic Forceps	116	Retractors	360
Raspatories	602	Protectors	473
Percussion Hammers	2-3	PROVIDENCE .Hemostatic Forceps	120
PERCY .Retractors	296	Pterygium Knives	469
Perforators	407	Ptosis Knives	469
Periosteal,Raspatories	274-281	Puncture Cannulas	482
Peritoneal,Clamp and Forceps	140-141	PUTTI .Bone Rasps	273
PERTHES ,Reamers	312	Pylorus Spreaders	339
Phalangeal,Knives	27		
PIERCE ,Septum Elevators	602	Q	
Trocars	8	QUERVAIN , Elevators	282
PIFFARD .Skin Hooks	328	QUINBY .Gum Scissors	92
PINARD .Stethoscopes	1	QUIRE ,Foreign Body Levers	570
PINSMED ,Razor Blade Breakers	30		
PIPER .Ostetrical Forceps	411	R	
Pituitary.Cuped-Shaped Forceps	538-539	Rachiotomes	31
Curettes	559-560	Radial Keratotomy Instruments	487,501
Dissectors	562	RANGELL-DAVIS .Retractors	159
Enucleators	561	RADOLF .Forceps For Tearing out Finger Nails	309
Forceps	538-539	RAMPLEY .Sponge Holding Forceps	148
Hooks	561-562	RAMUS .Retractors	185
Instruments	538-540,559-562	RANDALL .Biopsy Curettes	391
Raspatories	549,553	Kidney Stone Forceps	354
Rongeurs	535	RANEY .Applying and Removing Forceps	508
Scissors	538-540	Raspatories	601
Scoops	562	Raspatories For Maxillofacial Surgery	187
Spatulas	561	Rasps TC	606
Speculas	563	RAY .Curettes	559
Placenta and Ovum Forceps	406	Razors	26
PLANGE ,Foreign Body Needles	470	Razor Blade Holders and Breakers	30
Plaster.Cast Forceps	257	RECAMIER .Uterine Curettes	403
Knives	256	Rectal.Aspiration Cannulas	349
of Paris Shears	90	Biopsy Specimen Forceps	348
Saws	256	Coolers	349
Scissors	90	Snare	349
Spatulas	11	Speculas	344-345
Spreaders	256	REICHERT .Epiglottis Retractors	631
Plastic Surgery Scissors.SuperCut	35	REINER .Plaster Knives	256
PLESTER ,Micro Knives	578	RESANO ,Intestinal Clamp Forceps	336
Retractors	191	Resection,Knives	28
Suction Tubes	10	Saws	310
PLEY .Eye Speculas	460	Retractors,	150,179,190,209,296
POLITZER .Ear Speculas	564	For Maxillofacial Surgery	182-186
Knives	586-587	REVERDIN .Abdominal and Intestinal,Spatulas	180
POLLOSON ,Retractors	177	Needles	249-250

	Pages #
REYNOLDS .Scissors	52
Scissors. SuperCut	35-36
Rhinology Instruments	589-614
Rhinoplastic.Hooks	609
Knives	599-600
RHOTON ,Micro Surgical Instruments	545
Rib.Contractors	420
Shears	412
Spreaders	413-419
RICARD ,Abdominal	200
RICHARDSON ,Retractors	173-174
RICHARDSON-EASTMAN ,Retractors	173
RICHNAU-HOLMGREN ,Ear Speculas	566
RICHTER ,Scissors	42
Vulval Retractors	200
RICHTER-HEATH .Clip Applying Forceps	255
RIGBY .Abdominal Retractors	201
RITTER-HALLE ,Wash Cannulas	614
ROBERTS ,Hemostatic Forceps	126
ROCHESTER-CARMALT ,Hemostatic Forceps	22
ROCHESTER-PEAN ,Hemostatic Forceps	21
RODER ,Towel Forceps	43
Ligature Instruments	620
ROGERS ,Hysterectomy Forceps	135
ROGGE ,Sterilizing Forceps	632
ROLLET ,Extirpation Chisels	470
Tear Sac Hooks	472
ROSE .Trachea Retractors	157
ROSEN ,Micro Curettes	581
Micro Dissectors	581
Micro Hooks	579-580
Micro Knives	578
Micro Measuring Road	581
Micro Needles	579-580
ROSEN-KONIG ,Mouth Gags	616
ROSS .Retractors	181
ROUX .Retractors	160
RUBIN ,Septum Forceps	611
RUBMAN-BORES ,Corneal Fixation Forceps	501
RUDD .Haemorrhoidal Ligators	350
RUMEL ,Dissecting and Ligature Forceps	128
RUMEL-BELMONT ,Tourniquets	56
RUSKIN ,Bone Rongeur Forceps	303-304
RUSKIN-LISTON ,Bone Cutting Forceps	308
RUSSIAN ,Tissue Forceps	105
RYDEL-SEIFFER ,Tuning Forks	567
RYDER ,Needle Holders TC	238

S

SAALFELD ,Comedone Extractors	328
SACHS ,Elevators	518-519
Dissectors	518-519
SAENGER .Ovum Forceps	406
Safety Pins	632
SALENIUS ,Meniscotomy Knives	291
SAMIL ,Tumor Knives	548
SANDERS-BROWN .Awls	189
SANTULLI ,Bulldog Clamps	26
SANVENERO ,Scissors	55
SAROT ,Hemostatic Forceps	27
Needle Holders	231
Needle Holders TC	238
SATINSKY .Vascular Forceps	22
Vascular Scissors	57
SATINSKY-DE-BAKEY ,Tangential Occlusion Clamps	437
SATO .Corneal Knives	468
Knife Cannulas	482
SATTERLEE .Amputation Saws	310
SATTLER ,Muscle Forceps	491
SAUER ,Eye Speculas	460
SAUERBRUCH ,Bone Rongeur Forceps	306
Retractors	168,177
Rib Shears	412
Waste Forceps	632

SAUERBRUCH-FREY ,Rib Shears	412
SAUTER ,Air Injection Cannulas	182
SAUTTER .Orbit Spatulas	473
Scalp Flap Forceps	138
Scalpel Handles	20-21
SCHAEDEL .Towel Forceps	142
SCHAMBERG .Comedone Extractors	328
SCHUDE ,Bone Curettes	268
SCHIE ,Goniotomy Knives	469
SCH EINMANN ,Tips	629
SCH EPENS ,Lid Retractors	463
SCH ERBAK .Vaginal Speculas	378
Schimmelbusch Inhalers	14
SCHINDLER ,Hystrectomy Forceps	141
SCHLESINGER .Laminectomy Rongeurs	534
SCHMEDE ,Nasal Cutting Forceps	596
SCHMID ,Spatulas	215
Vessel Irrigating Cannulas	215
SCHMIDEN-DICK .Ligature Needles	248
SCHMIDEN-PAYR ,Ligature Conductors	253
SCHMIDEN-TAYOR .Dura Scissors	84
SCHNIDER .Periosteal Raspatories	275
SCHNIDER-SAUERBRUCH ,Periosteal Rasptaories	275
SCHNIDT ,Hemostatic Forceps	125
SCHOEMAKER-LOTH ,Wire Cutting Scissors	86
SCHOEBORN ,Thyroid Gland Retarctors	325
SCHRECK .Puncture Cannulas	462
SCHROEDER .Tenaculum Forceps	386
Uterine Curettes	399
SCHUBERT ,Cervical Biopsy and Specimen Forceps	393
SCHUHKNECHT .Wire Cutting Scissors	87
Knives	578
SCHUMACER ,Bone Levers	287
Cervical Biopsy and Specimen Forceps	394-395
Umbilical Scissors	62
Tips	629
SCHWEIZ ,Discission Needle	496
Scissors,	34-94
Abdominal	50
Arteritomy	60
Bandage	87-88
Cartilage	57
Cephalotomy	50
Clothing	90
Coronary	55
Crown	91
Dissecting	41,43-49,55,60,84
Dura	84
Enderectomy	36
Enterotomy	61
Enucleation	52
Episiotomy	62
Eye	80-83
Fine Operating Scissors	51-54,80
Fistula	50
Gum	92-94
Gynecological	40-41
Incision	42
Iridectomy	65-69
Iris	53
Iris SuperCut	35
Ligature	85-86
Lobectomy	61
Micro Dissecting	70-79
Nail	94
Nail Splitting	87
Nasal	37,63
Nerve Dissecting	60
Neuro Surgical	84
Parametrium	62
Plaster	90
Skin	53
Sternum	412
Strabismus	83
SuperCut	34-37
Tenotomy	37,82
Tissue	38-40,42-44
Tonsil	60-61

	Pages #		Pages #
Umbilical	62	SIMPSON-SMITH , Suction Tubes	13
Uterine	42,49-50	SIMS , Rectal Speculas,	344
Vascular	55-59	Uterine Curettes	402
Wire Cutting	86-87	Uterine Scissors	49
Scleral Hooks	472	Uterine Scissors SuperCut	35
Sclerotomes	469	Uterine Sounds	382
SCOVILLE , Nerve Retractors	524	Vaginal Speculas	370
Nerve Root Retractors	522-523	SIMS-MAIER , Dressing Forceps	146
SCOVILLE-HAVERFIELD , Retractors	203	SINGLEY-TUTTLE , Grasping Forceps	106
Screw, Drivers	318	Sinus Forceps	145
Nut Wrenches	318	SKENE , Tenaculum Forceps	386
SCUDDER , Intestinal Clamp Forceps	333	Skin, Curettes	328
SEBILEAU , Elevators	283	Hooks	329
Secretion Scoops	365	Scissors	53
SEDILLOT , Periosteal Raspatories	274	Skull Breakers	31
SEGOND , Hysterectomy Forceps	141	SLUDER-BALLENGER , Tonsillectome	625
Myoma Knives	390	SMELLIE , Perforators	407
SEGOND-LANDAU , Hysterectomy Forceps	141	SMILLIE , Meniscotomy Knives	291
SEIFFERT , Tips	629	Meniscus Retractors	290
SELDIN , Periosteal Raspatories	275	SMITH(USA PATTERN) , Bandage Scissors	89
SELLHEIM , Elevating Spoons	407	SMITH , Wire Cutting Scissors	87
SELLORS , Rib Contractors	420	SMITH-BUIE , Anal Retractors	345
SEMB , Bone Cutting Forceps	308	SMITH-FISHER , Iris Spatulas	485
Bone Holding Forceps	295	SMITH-PETERSON , Bone Chisels	260
Bone Rongeur Forceps	305	Bone Gouges	260
Bronchus Clamps	422	Bone Rongeur Forceps	304
Periosteal Raspatories	278	SMITHWICK , Nerve Retractors	526-527
SEMKEN , Dressing Forceps	96	SNELLEN , Ear Loops	585
Tissue Forceps	103	Entropium Forceps	491
SEMM , Abdominal Retractors	207	Lens Scoops	475
Vaginal Speculas	369	SOERENSEN-HEIN , Retractors	186
SENN-GREEN , Retractors	159	SOMER , Uterine Elevating Forceps	389
SENN-MILLER , Retractors	159	Spatulas Dissectors	553
Sensibility Instruments	1	Speculas, Eye	459-462
Septum, Chisels	604	For Laser Surgery	368
Compression Forceps	611	Lateral	368
Elevators	601-602	Rectal	344-345
Forceps	594-595,597	Vaginal	366-378
Knives	599-600	SPENCER , Ligature Scissors	85
Setting Forceps	424	SPENCER-FINE , Ligature Scissors	85
SEUTIN , Plaster and Bandage Scissors	90	SPENCER-WELLS , Hemostatic Forceps	134
SEYFFERT , Vaginal Speculas	369	Sphenoid Punches	584
SEWALL , Curettes	612	Sphincterosopes	346
SEXTON , Knives	586	SPINA-NASALIS , Retractors	185
SHAPLEIGH , Curettes	585	SPINAL , Bone Curettes	272
SHEA , Micro Scissors	573	Retractors	290
Spoons	582	Splinter Forceps	107-108
Shears, Plaster	90	Sponge Holding Forceps	148
Rib	412	Spoons For Ear	585
SHEETS , Irrigating Vectis Cannulas	480	SPRAGUE , Ear Operation Set	587
SHEPARD , Forceps	499	SPRATT , Bone Curettes	267
SHORTBENT , Ligature Scissors	85	SPURLING , Laminectomy Rongeurs	530-531
SICHEL , Iris Knives	468	ST.CLAIR-THOMPSON , Adenoid Curettes	613
SICKLE , Dissectors	549,553	ST.MARKS , Retractors	171
Elevators	549	ST.MARTIN , Suture Forceps	504
Hooks	550-551	STACK , Probes	210
Knives	549	STANDARD-NELSON , Trocars	6
Needles	549	STAUDE-MOORE , Tenaculum Forceps	385
Raspatories	549	STEINMANN , Tendon Grasping Forceps	323
SIEBENMANN , Wash Cannulas	614	Tendon Passing Forceps	324
SIEBOLD , Uterine Scissors, SuperCut	35	STELLBRINK , Bone Rongeur Forceps	299
SIEGLE , Ear Speculas	566	Sterilizing, Forceps	632
SILVER , Chisels	604	Instruments	632
SIMCOE , Capsule Polishing Cannulas	480	STERNBERG , Tongue Depressors	617
Cortex Aspirating Cannulas	480	Sternum, Chisels	412
Irrigating Vectis Cannulas	480	Scissors	412
Irrigating/Aspiration Cannulas	479	Stethoscopes	1
SIMON , Bone Curettes	269	STEVENS , Iris Forceps	495
Fistula Hooks	390	Lens Hooks	473
Fistula Knives	26	Micro Needle Holders	225
Retractors	175	Tenotomy Scissors	82
Uterine Curettes	399	Tenotomy Scissors, SuperCut	37
SIMPSON , Lachrymal Dilators	484	STEVENSON , Eye Speculas	462
Obstetrical Forceps	409	STIEGLITZ , Splinter Forceps	108
Uterine Sounds	382	STILLE , Bone Chisels	263
SIMPSON-BRAUN , Obstetrical Forceps	409	Bone Gouges	263
SIMPSON-LUIKART , Obstetrical Forceps	409	Bone Osteotomes	263

	Pages #		Pages #
Bone Rongeur Forceps	306	Picks	544,610
Double Ended Instruments	485	TOBOLD , Tongue Depressors	618
Dressing Forceps	95	TOENNIS , Dissecting and Ligature Forceps	131
Kidney Pedicle Clamp Forceps	353	Dissecting Scissors	22
Plaster of Paris Shears	90	Dissecting Scissors.TC	60
STILLE-BARRYA , Tissue Forceps	106	Dissectors	517
STILLE-LISTON , Bone Cutting Forceps	308	Knives	525
STILLE-LUER , Bone Rongeur Forceps	305	Needle Holders	233
STILLE-RUSKIN , Bone Rongeur Forceps	306	Needle Holders TC	241
STOCK , Iris Spatulas	473	Nerve Retractors	525
STOCKMANN , Penis Clamps	365	TOENNIS-ADSON , Dissecting Scissors	60
Stomach and Intestinal Instruments	330-343	TOENNIS-ADSON-FINE , Arteriotomy Scissors	60
Stomach Clamp Forceps	340-341,343	TOHOKU , Towel Forceps	142
STONE , Tissue Forceps	101	Tongue, Depressors	616-619
Strabismus, Forceps	489-490	Forceps	619
Hooks	473	Tonsil, Elevators	622
Scissors	83	Forceps	136,623
STRANDELL-STILLE , Retractors	158	Hemostatic	136,623
STRATTE , Needle Holders TC	239	Instruments	621-625
STRAUSS , Penis Clamps	365	Knives	621
STRULLY , Neurosurgical Scissors	64,84	Needles	620
STRUMPEL , Ear Polypus Forceps	571	Punches	625
STRUYCKEN , Nasal Cutting Forceps	596	Retractors	622
Suction and Irrigating Cannulas	456	Scissors	61-62
Suction Tubes	9-13,568	Seizing Forceps	622
SUCKER , Eye Spatulas	473	Snares	624
SULLIVAN , Gum Scissors	93	Tonsillectomes	625
SuperCut Scissors	34-37	TOOK , Corneal Kinves	468
Suture, Forceps	488-489	Tourniquets	456
Instruments	216-255	Towel Forceps	142-143
Pusher and Knot Tiers	544	TOWNLEY , Calipers	5
SWEDISH-PATTERN , Bone Curettes	267	TOWNSEND , Biopsy Curettes	392
Needle Holders TC	238	TOYNBEE , Ear Speculas	564
SCHWEIZ-MOD , Foreign Body Needles	469	Trachea, Dilators	325
SWISS PATT , Iris Forceps	492	Retractors	325
Vaginal Speculas	366	Trocars	325
		Tubes	326
		Tracheotomy Instruments	325-326
		Trachoma Forceps	500
		Traction Handle for Obstetrical Forceps	410
		TRAUBE , Percussion Hammers	3
		TRAVERS , Retractors	195
		TRELAT , Tonsil Needles	620
		TRELET , Vaginal Speculas	367
		TREVES , Tissue Forceps	101
		Trigeminal Scissors	64
		Trocars	6-8
		TROELTSCH , Ear and Nasal Forceps	111
		Ear Speculas	564
		TROELTSCH-WILDE , Ear and Nasal Forceps	111,569
		Tampon Forceps	593
		TROEMNER , Percussion Hammers	2
		TROUSSEAU , Trachea Dilators	325
		TROUSSEAU-BABY , Trachea Dilators	325
		TROUTMANN , Iridectomy Scissors	68
		Lens Scoops	475
		TROUTMANN-BARRAQUER , Iridectomy Scissors	67
		TROUTMANN CASTROVIEJO , Iridectomy Scissors	69
		TROUTMANN-CHRIS , Razor Blade Breakers	30
		TROUTMANN-COLIBRI , Iris Forceps	497
		Trumper Guide Needles	405
		TUBBS , Aortic Dilators	457
		Tubing Forceps	144
		TUEBINGEN , Iris Hooks	470
		Retractors	176,192
		Suture Forceps	488
		TUFFIER , Abdominal and Intestinal Spatulas	180
		Hemostatic Forceps	115
		Retractors	175
		Rib Spreaders	414
		Tumor Grasping Forceps	112-113,535
		Knives	548
		Tuning Forks	567-568
		Twin Clamp Forceps	341,343
		TYDING , Tonsil Snares	624

T

TABB , Micro Forceps	573
Micro Knives	578
TAKAHASHI , Septum Forceps	595
Tampon Forceps	593
Tangential Occlusion Clamps	437
TARNIER , Basiotribes	408
Obstetrical Forceps	411
TAYLOR , Dressing Forceps	97
Nerve Root Retractors	523
Percussion Hammers	2
Spinal Retractors	290
Tissue Forceps	103
TEALE , Tenaculum Forceps	388
Tenaculum Forceps	385-388
Tendon, Grasping Forceps	122,323
Passing Forceps	322
Seizing Instruments	322-324
Sheath Hooks	158
Strippers	322
Tunnel Instruments	322-324
TERRIER , Hemostatic Forceps	116
TERSON , Capsular Forceps	497-498
TESSIER , Osteotomes	188
Retractors	186
THOMAS , Uterine Curettes	400
THOMSON-WALKER , Bladder Retractors	362
THOMS-ALLIS , Intestinal Tissue Forceps	330
THOMS-GAYLOR , Cervical Biopsy and Specimen Forceps	393
Thoracic Retractors	417
THUDICHUM , Nasal Speculas	592
THUDICHUM (GOLDSMITH) Nasal Speculas	592
Thyroid Gland Retractors	325
TIECK , Nasal Speculas	590
TILLY , Ear Polypus Forceps	570
TISCHER , Cervical Biopsy and Specimen Forceps	393,398
TISCHER-MORGAN , Cervical Biopsy and Specimen Forceps	396
Tissue, Forceps	100-106,502
Lifters	610

INDEX

	Pages #		Pages #
UCKERMANN ,Cotton Applicators	212	WALTER ,Chisels	604
Trachea Trocars	325	WALTER-CARMALT ,Splinter Forceps	108
UFFENORDE ,Bone Curettes	268	WALTON ,Foreign Body Chisels	470
ULRICH ,Cotton Swab Forceps	145	Scissors	53
Fistula Knives	26	WANGENSTEEN ,Dressing Forceps	99
Vaginal Speculas	375	Needle Holders	231
Umbilical,Cord Clamps	408	Needle Holders TC	239
Scissors	62	WARTENBURG ,Sensibility Instruments	1
UNIVERSAL .Bandage Scissors	87	WASSMUND ,Retractors	166
Cotton Applicators	212	Waste Forceps	632
Handles	628	Watchmaker's Forceps	106,504
Sterilizing Forceps	632	WATSON-CHEYNE ,Elevators	283
Trocars	6	Probes	210
Wire Cutting Scissors	86	WATSON-WILLIAMS ,Septum Forceps	595
Wire Cutting Scissors TC	64	WAUGH ,Dressing Forceps	97
UNNA ,Comedone Extractors	328	Tissue Forceps	104
Urology Instruments	365	WEBER ,Aortic Clamps	436
USA ,Bone Chisels	258	Canaliculus Knives	467
Bone Gouges	258	Lens Scoops	475
Bone Osteotomes	258	Sensibility Instruments	1
Dressing Forceps	95	WEBSTER ,Needle Holders	229
Perineum Scissors	62	Needle Holders TC	235
Plaster Spreaders	256	WECKER ,Iridectomy Scissors	65
Tissue Forceps	101	Iris Spatulas	473
Uterine,Curettes	399-404	WEISS ,Eye Speculas	459
Depressors	382	WEIL-BLAKESLEY ,Laminectomy Rongeurs	536
Dilators	379-381	Nasal Cutting Forceps	596
Elevating Forceps	389	WEITLANER , Retractors	192,194
Hemostatic Forceps	406	WEITLANER-BABY ,Retractors	193
Polypus	388	WEITLANER-WULLSTEIN ,Retractors	192
Scissors	48-49	WELLS ,Enucleation Scoops	476
Scissors Super Cut	35	WERTHEIM .Clamp Forceps	138,140
		Gynecological Scissors	49
		Peritoneal Clamp Forceps	138-139
		WERTHEIM-CULLEN ,Clamp Forceps	138
		WESSELEY-GRIESHABER .Keratomes	466
		WEST ,Lachrymal Sac Chisels	483
		Lachrymal Sac Gouges	483
		Septum Chisels	605
		Septum Gouges	605
		Tampon Forceps	593
		WESTCOTT .Iridectomy Scissors	68
		WESTMACOTT .Tampon Forceps	593
		WHEELER .Cataract Knives	464
		Cyclodialysis Spatulas	485
		WHITE .Tonsil Forceps	623
		WHITEHEAD ,Mouth Gags	617
		WICKSTROEM .Dissecting and Ligatur Forceps	133
		WIEN ,Ligature Catchers	254
		Nasal Speculas	591
		WIENER ,Iris Hooks	471
		Keratomes	466
		WILDE ,Ear Forceps	111
		WILDER ,Lachrymal Dilators	483
		Tongue Depressors	619
		WILLET-MARTELL .Scalp Flap Forceps	407
		WILLIAMS ,Eye Speculas	461
		Intestinal Tissue Forceps	331
		WILLIGER ,Bone Curettes	268,271
		Elevators	282
		Mallets	320
		Periosteal Raspatories	275-276
		WILMER ,Eye Scissors	83
		WINTER ,Ovum Forceps	406
		Wire.Closure Forceps	576
		Cutting Pliers	315-316
		Cutting Pliers TC	316
		Cutting Scissors	87
		Cutting Scissors TC	64
		Guides	319
		Seizing Forceps	313-314
		Seizing Forceps TC	313
		Strainers For Extension Bows	318
		Twisting Forceps	319
		WITTNER ,Cervical Biopsy and Specimen Forceps	395
		WOLFF ,Lupus Curettes	329
		Plaster Cast Forceps	257
		WOODRUFF ,Ligature Needles	505

V

Vaginal, Forceps	138-139
Sounds	382
Retractors	374,378
Speculas	366-378
Speculas For Laser Surgery	368
VALLEIX .Uterine Sounds	382
VAN BUREN ,Bone Holding Forceps	292
Dilating Bougies	363
VAN DOREN ,Cervical Biopsy and Specimen Forceps	393
VANNAS ,Iridectomy Scissors	66
Micro Scissors	70
VANNAS TUEBINGEN PATTERN ,Iridectomy Scissors	66
Varicose Vein Probe Set	214
Vascular, Dilators	458
Scissors	55-59
Retractors	157
Scissors	74
Strippers	214
Vein Scissors	74
VERBRUGGE ,Bone Holding Forceps	295
VERBRUGGE-MULLER .Bone Levers	288
VERINER ,Calipers	5
Vessel,Irrigating Cannulas	215
Dilators	544
Probes	544
VIDAL .Lupus Scrapers	329
VIENNA ,Nasal Specula	591
VRCHOW .Autopsy Knives	29
VOLKMANN ,Bone Curettes	265,269
Retractors	156,162-163
Vulval Retractors	200

W

WACHENFELDT .Clip Applying Forceps	255
WAGNER ,Bone Levers	286
Foreign Body Hooks	586
Periosteal Raspatories	281
Scissors	51
Scissors. SuperCut	35
WALSHAM ,Septum Straightening Forceps	611
WALLICH .Abortion Scoops	406

	Pages #
WOODSON ,Dissectors	518
WORTH ,Advancement Forceps	490
Wound and Nerve Hooks	150-151
Trachea Retractors	152-153,155-156
Vein Retractors	157
WRIGLEY ,Obstetrical Forceps	409
WULLSTEIN ,Micro Knives	578
WURZBURG Jongue Drepessors	616

Y

YANKAUER ,Elevators	282
Inhalers	14
Suction Tubes	11
Tonsil Elevators	622
YASARGIL ,Brain Suction Tube	9,13
Dissectors	542
Ligature Guides	543
Micro Grasping Forceps	113-114
Micro Needle Holders	220
Micro Raspatories	542
Micro Vessel Knives	541
Micro Scissors	70-71
Micro Scoops	542
Tumor Grasping Forceps	112-113
YASAR-NICOLA ,Pituitary Instruments	539
YEOMAN ,Biopsy Specimen Forceps	348
Rectal Biopsy Specimen	348
YOUNG .Prostatic Retractors	360
Suture Instruments	249
Tongue Forceps	619

Z

ZAUFAL .Foreign Body Instruments	586
ZAUFAL-JANSEN ,Bone Rongeur Forceps	300-303
ZENKER ,Dissecting and Ligature Forceps	128
Retractors	179
ZIEGLER ,Capsulotomy Knives	467-468
Cilia Forceps	110
Discission Knives	468
ZIELKE ,Bone Gouges	263
ZOLLNER .Ear Speculas	565
Micro Instruments	583
ZWEIFEL ,Needle Holders TC	241
Pressure Clamps	137



CORNERSTONE
CORPORATION

P.O. Box # 1333, Nai Abadi Bhoth,
Sialkot 51310 - Pakistan.

Phone: +92-52-4271651

Fax: +92-52-4263208

Email: cstone@brain.net.pk
info@corner-stone.biz

Website: www.corner-stone.biz